

ARCHIVE

This information was updated on February 10, 2008. Shimano makes no warranty with respect to this information, including without limitation any warranty on the accuracy of measures, specifications and compatibility of the current products. Regarding any modification and new product information after February 10, 2008, please refer to the Shimano Business Customer Web Site or directly contact the sales person of our company.

SHIMANO

2008-2009

Products

Line-up Chart

All information in this Products Lineup chart is confidential and has been given to you for the sole of your product development staff.

This information should not be photo copied.

Specifications are subject to change without prior notice.

Issued on Feb. 10, 2008

SHIMANO INC.

Printed in Japan

INDEX



NEW model



Minor change

Mountain Bike

XTR P. 2

SAINT P. 3

DEORE XT P. 4

SLX P. 5

SHIMANO DEORE P. 6

ALIVIO P. 7

ACERA/ALTUS P. 8

BMX

DXR P.9

Trekking Bike

DEORE XT P.10

DEORE LX P.11

Comfort

NEXAVE C810 P.12

NEXAVE T300 P.13

Tourney series

3x7 speed P.14

3x6 speed P.15

7 speed SIS P.16

6 speed SIS P.17

Road Bike

DURA-ACE P.18

ULTEGRA P.19

105 P.20

TIAGRA P.21

SORA P.22

2200/A050 P.23

Folding Bike

CAPREO P.24

ALFINE P.25

NEXUS

Cyber Nexus P.26

INTER-8 P.27

INTER-7 P.28

AUTO-D (w/ INTER-3) P.29

INTER-3 P.30

XTR (Mega 9 drivetrain 27- speed)

27-SPEED

V-BRAKE spec



BL-M970
V-BRAKE Lever



SL-M970
RAPIDFIRE-PLUS Lever



ST-M970
Dual Control Lever
for V-BRAKE

Disc brake spec



ST-M975
Dual Control Lever
for hydraulic
disc brake



SL-M970
RAPIDFIRE-PLUS Lever



NEW BL-M975A
hydraulic disc
brake lever



RD-M970-GS/SGS
Low normal



FD-M970
TOP SWING FD
Dual pull
Multi clamp
CL: 50 mm



FC-M970
HOLLOWTECH II
crank set
w/BB unit
44-32-22T
44-32-24T
CL: 50 mm



BR-M970
V-BRAKE



BR-M975
Disc brake caliper
for international
standard mount



BR-M975P
Disc brake caliper
for Post mount



SM-BH59
Brake hose



WH-M970
V-BRAKE USE

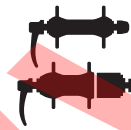

HB-M970
FH-M970

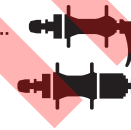

HB-M975
FH-M975
Center Lock mount



WH-M975
Center Lock mount
Disc brake use only



HB-M976
20 mm axle
Center Lock mount



NEW HB-M978
15 mm axle
Center Lock mount



RD-M972-GS/SGS
Top normal
Shimano Shadow
Rear Derailleur



FD-M971
Conventional style
Dual pull
Multi clamp
CL: 50 mm



SM-RT97
Disc rotor (160mm)
Center Lock mount



SM-RT97-L
(230mm)



SM-RT97-M
(180mm)



SM-RT97-SS
(140mm) Rear only



CS-M970
9-speed HG CS
11-32T
11-34T
12-34T



CN-7701
Super narrow
HG chain



PD-M970



SIS-SP41
Shifting outer
cable housing



CP-FH53
CP-FH56
for
FH-M975
FH-M970

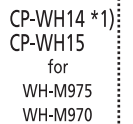

CP-WH14 *1)
CP-WH15
for
WH-M975
WH-M970

*1) CP-WH14 : for CS-M970 (11-32T/11-34T/12-34T)
CP-WH15 : for CS-M770 (11-32T/11-34T)

SAINT

9/18-SPEED



For 83 mm BB Shell width

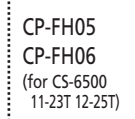
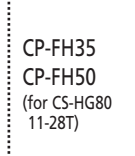
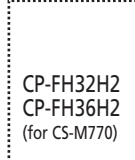
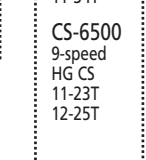
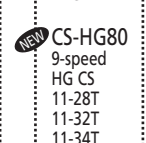
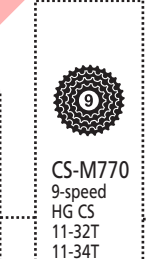
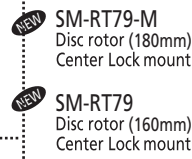
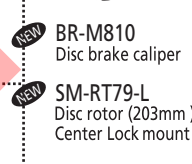
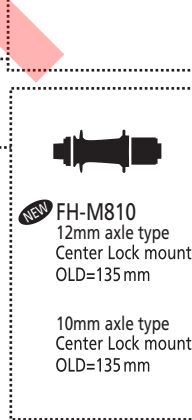
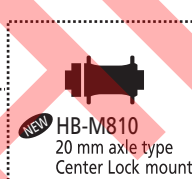
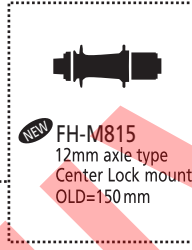
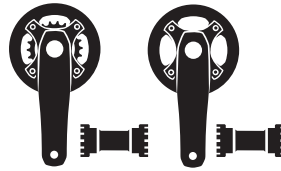
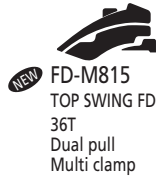

For 68/73 mm BB shell width

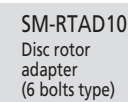
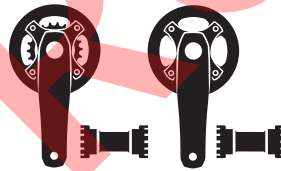

DEORE XT (Mega 9 drivetrain 27- speed)

For all mountain

27-SPEED



SL-M770
RAPIDFIRE-PLUS
shifter

BL-M775
Hydraulic disc
brake lever
Servo wave



RD-M772-SGS
RD-M772-GS
Top normal
Shimano Shadow
Rear Derailleur

Chainstay angle (degree)
66-69



FD-M770
TOP SWING FD
44/48T
Dual pull
Multi clamp
CL: 50 mm



FD-M770-E
TOP SWING FD
44T
BB-mount
Dual pull
CL: 50 mm



FD-M771
Conventional style
44T
Dual pull
Multi clamp
CL: 50 mm

NEW FD-M771D
Conventional style
Direct mount type
44T



FC-M770
HOLLOWTECH II
crankset w/BB unit
44-32-22T
CL: 50 mm



BR-M775
Brake caliper
for post mount

NEW BR-M776
(Banjo Connector)
Brake caliper

NEW SM-RT79
Disc rotor (160 mm)
Center Lock mount

NEW SM-RT79M
Disc rotor (180 mm)
Center Lock mount

NEW SM-RT79L
Disc rotor (203 mm)
Center Lock mount

SM-BH59
Brake hose



BR-M770
V-BRAKE



HB-M776
20 mm axle
Disc brake
Center lock
mount

NEW HB-M778
15 mm axle
Disc brake
Center lock
mount

NEW HB-M775
FH-M775
For disc brake
Center lock
mount

NEW HB-M770
FH-M770
For conventional
MTB / V-BRAKE



WH-M776
20 mm axle
Disc brake
Center lock
mount

NEW WH-M778
15 mm axle
Disc brake
Center lock
mount



WH-M775
For disc brake
Center lock
mount

NEW WH-MT75
for 29er
For disc brake
Center lock
mount



WH-M770
For conventional
MTB / V-BRAKE



CS-M770
9-speed HG CS
11-32T
11-34T



CN-HG93
Super narrow
HG chain



PD-M770



PD-M647
PD-M545



SIS-SP41
Shifting outer
cable housing



SM-SP17
(SM-SP18)



CP-FH56
for 32H



CP-FH53
for 36H



CP-WH14
for WH-M770



CP-WH15
for WH-M775



WH-M776

SM-RT75-S
Disc rotor (160 mm)
6 bolts rotor mount

SM-RT75-MA
Disc rotor (180 mm)
6 bolts rotor mount

SM-RT75-DH
Disc rotor (203 mm)
6 bolts rotor mount

HB-M756
FH-M756
6 bolts
Rotor mount

NEW HB-M758
15mm axle
for 6 bolts

SM-RTAD10
Disc rotor
adapter



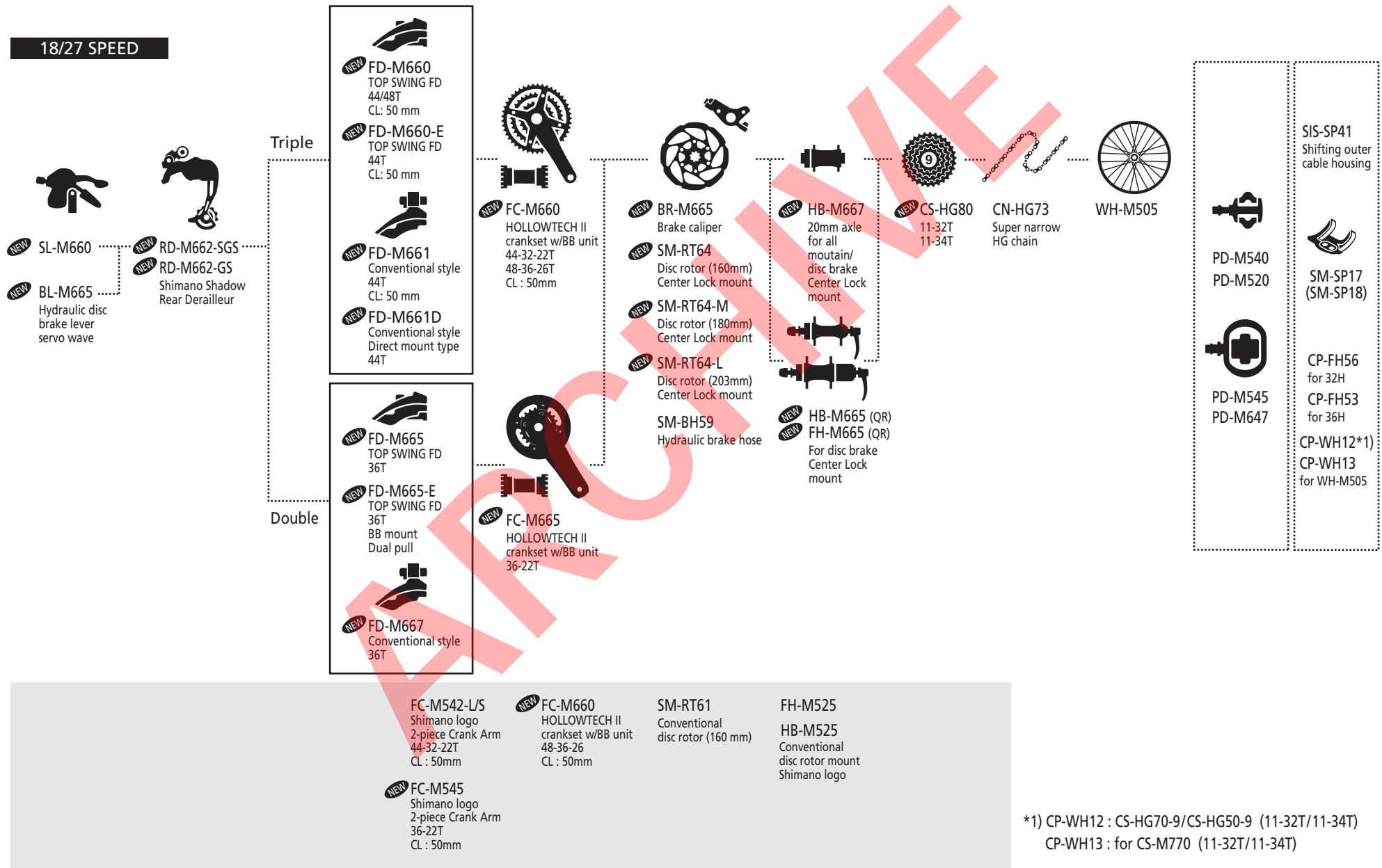



SLX (Mega 9 drivetrain 18/27-speed)







*1) CP-WH12 : CS-HG70-9/CS-HG50-9 (11-32T/11-34T)
CP-WH13 : for CS-M770 (11-32T/11-34T)

Deore (Mega-9 drivetrain 27-speed)

27-SPEED











-  ST-M535
Dual Control Lever
for hydraulic disc brake
-  BL-M535
Hydraulic
disc brake lever
-  SL-M530
RAPIDFIRE-PLUS shifter
-  BL-M511
V-BRAKE lever
-  ST-M530
Dual Control Lever
for V-BRAKE
-  **NEW** BL-M575
Hydraulic disc
brake lever

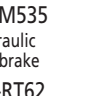

-  RD-M530-SGS
Low normal
-  RD-M531-SGS
Top normal

| Chainstay angle (degree) | |
|-----------------------------------------------------------------------------------------------------------------------------------------------------------------------------|-----------------------------------------------------------------------------------------------------------------------------------------------------------------------------|
| 66-69 | 63-66 |
|  FD-M530-6 TOP SWING FD for 44/48T Dual pull Multi clamp CL: 50 mm |  FD-M530-3 TOP SWING FD for 44/48T Dual pull Multi clamp CL: 50 mm |
|  FD-M531-6 Conventional style for 44/48T Dual pull Multi clamp CL: 50 mm |  FD-M531-3 Conventional style for 44/48T Dual pull Multi clamp CL: 50 mm |

-  FC-M532-L/S
2-piece Crank Arm
44-32-22T
48-36-26T
CL: 50 mm
-  FC-M533-LK/SK
TREKKING
2-piece Crank Arm
44-32-22T
48-36-26T
chaincase compatible
CL: 50 mm







Disc brake / Hydraulic type

-  BR-M535
Hydraulic
disc brake
-  SM-RT62
Disc rotor (160 mm)
Center Lock mount
-  SM-RT62-M
Disc rotor (180 mm)
Center Lock mount
-  SM-RT62-L
Disc rotor (203 mm)
Center Lock mount
-  SM-BH59
Hydraulic
brake hose
-  **NEW** BR-M575
Hydraulic
disc brake
-  SM-RT53
Disc rotor (160 mm)
Center Lock mount
for resin pad only
-  SM-RT53M
Disc rotor (180 mm)
Center Lock mount
for resin pad only
-  SM-RT53L
Disc rotor (203 mm)
Center Lock mount
for resin pad only
-  HB-M535
FH-M535
Center Lock
mount

-  **NEW** CS-HG61-9
9-speed HG CS
11-32T
11-34T
-  CN-HG73
CN-HG53

V-BRAKE

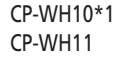
-  BR-M530
V-BRAKE
-  HB-M530
FH-M530

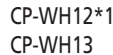
| | | |
|---------------------------------------------------------------------------------------|---------------------------------------------------------------------------------------|---------------------------------------------|
|  |  | |
| SM-SP17 SM-BT17 (SM-SP18) (SM-BT18) | PD-M424 | |
|  | | SIS-SP41 Shifting outer cable housing |
| SM-PM40 Power modulator | | |
|  |  | CP-FH75 CP-FH76 for Disc brake hub |
| WH-T565 Trekking use Center Lock rotor mount | PD-M540 PD-M520 PD-M505 | |
|  | | CP-FH56 CP-FH53 |
| CP-WH10*1) CP-WH11 | | |
|  |  | |
| WH-M505 MTB use Rim and Disc Brake (Center Lock) versions available | PD-M324 | |
|  | | |
| CP-WH12*1) CP-WH13 | | |

- NEW** BL-M486
Hydraulic disc
brake lever
- FD-M510
Top swing FD
for 44/48T
Chainline 47.5/50 mm
Dual pull
Multi clamp
- FD-M511
Conventional style
for 44/48T
Chainline 47.5/50 mm
Dual pull
Multi clamp
- BB-ES25
OCTALINK BB
- BB-UN26
Square BB
- SM-RT61
6-bolts disc rotor
(160 mm)
- CS-HG50-9
11-32T
11-34T
- FC-M442
OCTALINK version
available
44-32-22T
48-36-26T
chaincase compatible
CL: 47.5/50 mm
- NEW** BR-M486
Hydraulic
disc brake
- FC-M443
OCTALINK version
available
44-32-22T
48-36-26T
Chaincase compatible
CL: 47.5/50 mm
- HB-M525
FH-M525
6-bolts
disc rotor mount
Shimano logo
- FD-M510
Top swing FD
for 44/48T
Chainline 47.5/50 mm
Dual pull
Multi clamp
- FC-M542-L/S
Shimano logo
2-piece Crank Arm
44-32-22T
CL: 50 mm
- FC-M543-LK/SK
Shimano logo
2-piece Crank Arm
44-32-22T
48-36-26T
chaincase compatible
CL: 50 mm
- FC-M521-L/S
Shimano logo
OCTALINK
44-32-22T
48-36-26T
chaincase compatible
CL: 50 mm

*1) CP-WH10/WH12 : CS-HG61-9/CS-HG50-9 (11-32T/11-34T)
CP-WH11/WH13 : CS-M770 (11-32T/11-34T)

Alivio series (Front HD drivetrain 24-speed)

24-SPEED

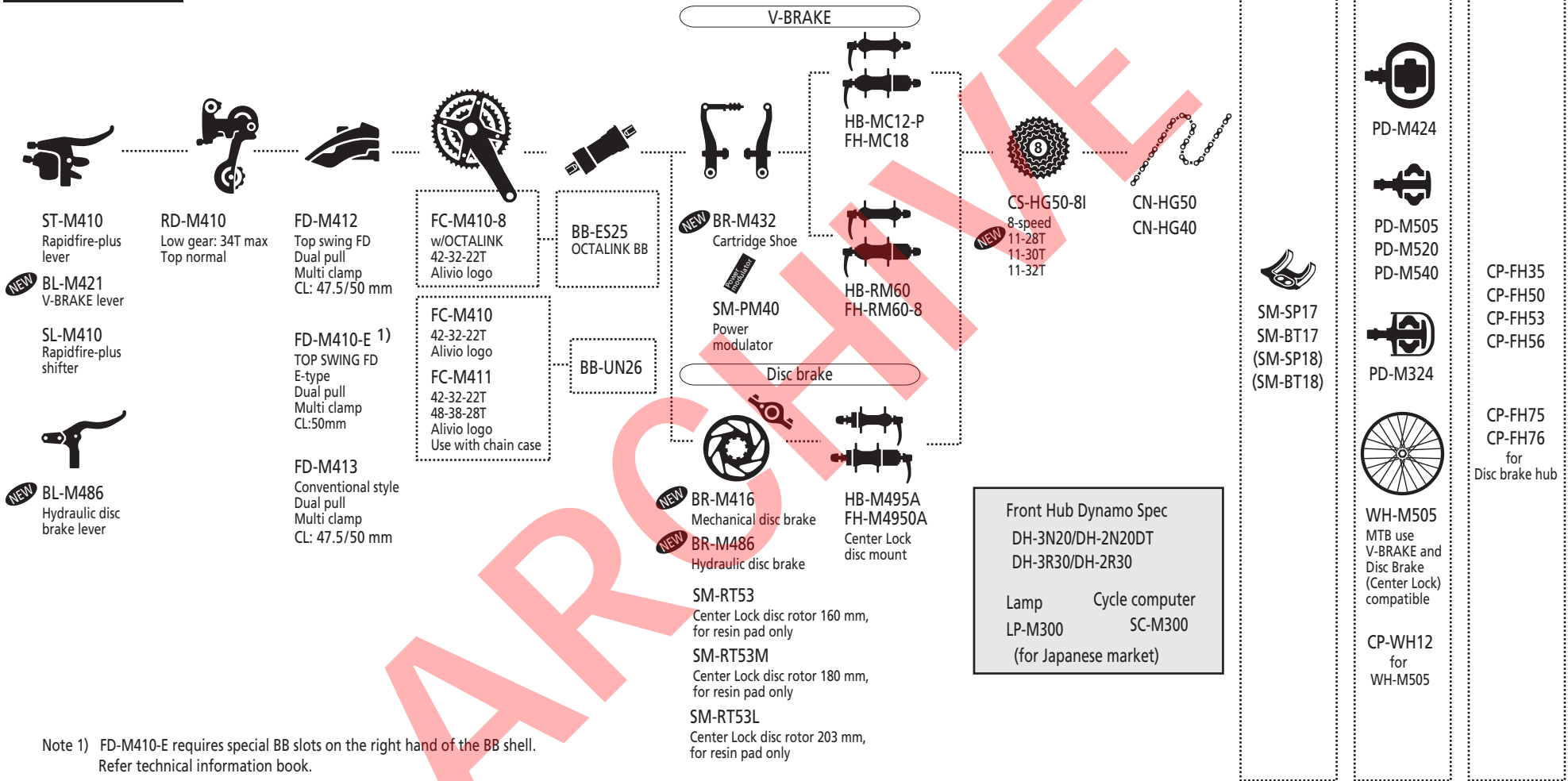

Note 1) FD-M410-E requires special BB slots on the right hand of the BB shell.
Refer technical information book.

ST-M405
8-speed/EZ FIRE Plus lever

BR-M422
V-BRAKE

BR-M495
Mechanical disc brake

SM-RT51
6 bolts rotor (160mm)
for resin pad only

SM-RT51M
6 bolts rotor (180mm)
for resin pad only

HB-M475
FH-M475
6 bolts
Disc rotor
mount

HB-RM40
FH-RM30-8

CS-HG40-8I
CS-HG30-8I
8-speed

Acera/Altus series (Front HD drivetrain 24-speed)

24-SPEED

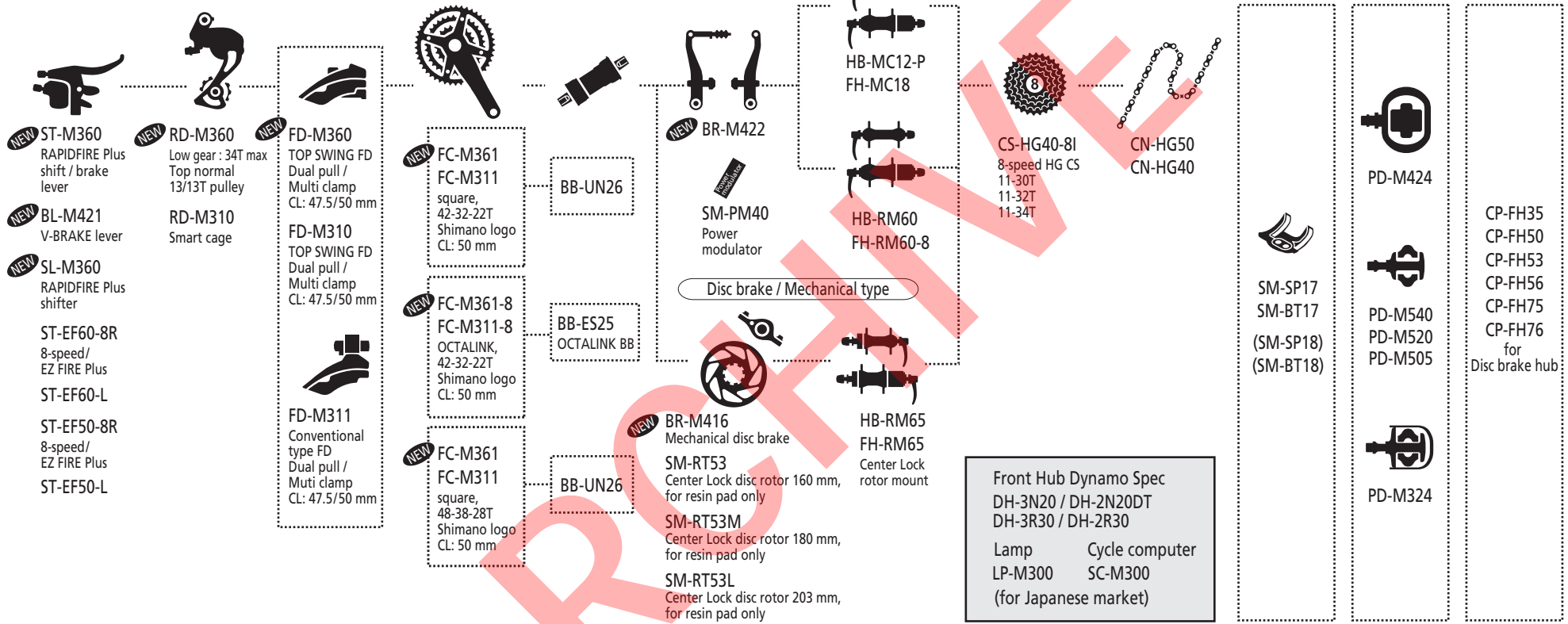

| | | | | | | |
|--------------------------|---------------------------------------------------------------------------------------|-----------------------------------------------------------------------|-----------------------------------------------------------------------|---------------------------------------------------------------------------------------------------------------------------|---------------------------------------------------------------------------|-----------------------------------------------------|
| SL-RS43-8R SL-RS41-8R | FD-T301 for 48-38-28T CL: 47.5 mm FD-M190 for 42-34-24T CL: 47.5/50 mm | FC-M191 Square 42-34-24T 48-38-28T CL: 47.5 mm BB-UN26 | FC-M151 Square 42-34-24T 48-38-28T CL: 47.5 mm BB-UN26 | SM-RT51 6 bolts Rotor (160 mm) for resin pad only SM-RT51M 6 bolts Rotor (180 mm) for resin pad only | HB-M475 FH-M475 6 bolts Rotor mount type HB-RM40 FH-RM30-8 | CS-HG30-8I 8-speed 11-30T 11-32T 11-34T |
|--------------------------|---------------------------------------------------------------------------------------|-----------------------------------------------------------------------|-----------------------------------------------------------------------|---------------------------------------------------------------------------------------------------------------------------|---------------------------------------------------------------------------|-----------------------------------------------------|

| | | | | | | |
|-----------------------------------------------------------------------------------|---------------------------|--|--|-----------|------------|---------|
| 7-speed ST-EF60-7R ST-EF50-7R SL-RS43-7R SL-RS41-7R BL-M421 | FD-C050 CL: 47.5/50 mm | | | FH-RM30-7 | CS-HG30-7I | CN-UG51 |
|-----------------------------------------------------------------------------------|---------------------------|--|--|-----------|------------|---------|

DXR

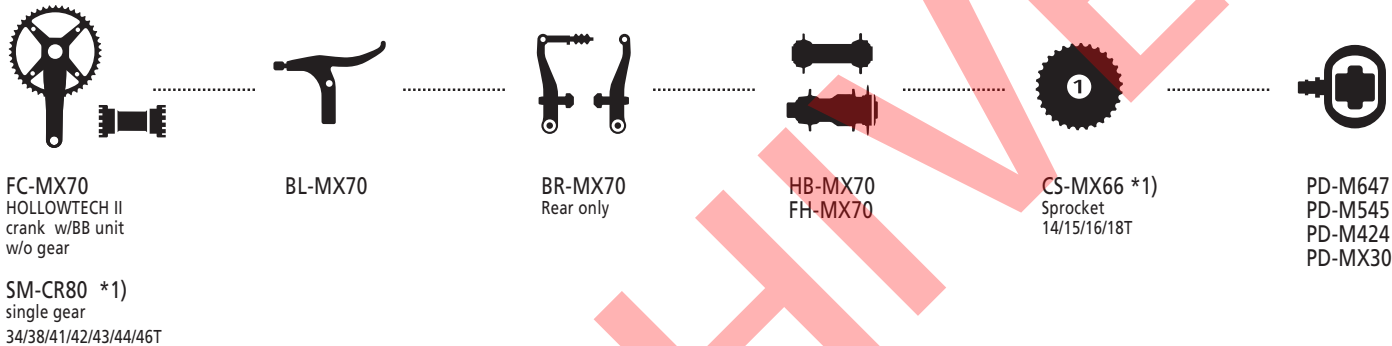

*1) CHAIN SIZE: 1/2 x 3/32

DEORE XT (Trekking Specification, 9-speed drivetrain 27-speed)

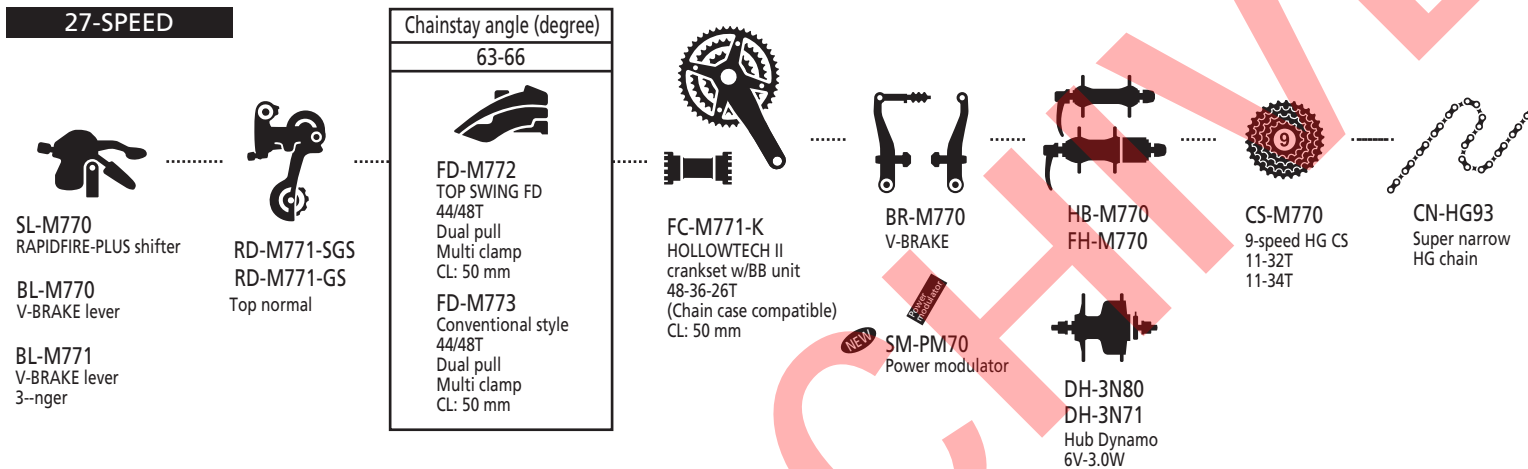

| | |
|-------------------------------------------------------------------------------------------------------------------|------------------------------------------------------------------|
| FD-M770 TOP SWING FD 44/48T Chain stay angle (66-69°) Dual pull Multi clamp CL: 50 mm | FD-M751 Conventional style 44/48T CL: 47.5/50 mm |
| FD-M750 TOP SWING FD 44/48T CL: 47.5/50 mm | |

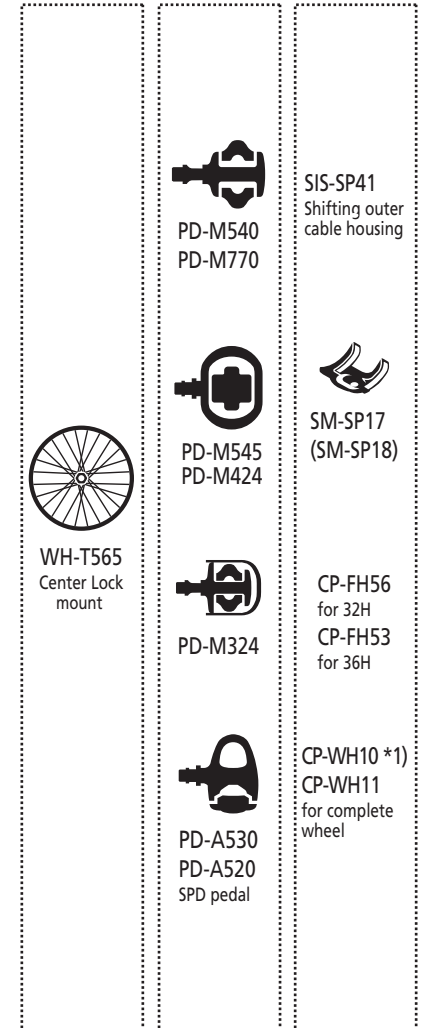

*1) CP-WH10 : for CS-M970 (11-32T/11-34T)
CP-WH11 : for CS-M770 (11-32T/11-34T)

DEORE LX (9-speed drivetrain 27-speed)

27-SPEED



| Chainstay angle (degree) | |
|-----------------------------------------------------------------------------------------------------|-----------------------------------------------------------------------------------------------------|
| 66-69 | 63-66 |
| <p>NEW FD-T660-6 TOP SWING FD for 44/48T Dual pull Multi clamp</p> | <p>NEW FD-T660-3 TOP SWING FD for 44/48T Dual pull Multi clamp</p> |
| <p>NEW FD-T661-6 Conventional style for 44/48T Dual pull Multi clamp</p> | <p>NEW FD-T661-3 Conventional style for 44/48T Dual pull Multi clamp</p> |

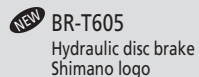
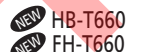

| | | |
|-----------------------------------------------------------------|------------------------------------------|------------------------------------------------------|
| <p>WH-T565 Trekking use Center Lock rotor mount</p> | <p>PD-M540 PD-M520</p> | <p>SIS-SP41 Shifting outer cable housing</p> |
| <p>CP-WH10 *1) CP-WH11 for complete wheel</p> | <p>PD-M545 PD-M424</p> | <p>SM-SP17 (SM-SP18)</p> |
| | <p>PD-M324</p> | <p>CP-FH56 CP-FH53</p> |
| | <p>PD-A530 PD-A520 SPD-Pedal</p> | |

*1) CP-WH10 : for CS-HG50-9/CS-HG61-9/CS-HG80-9 (11-32T)
CP-WH11 : for CS-M770 (11-32T)

NEXAVE C810 (Di2)

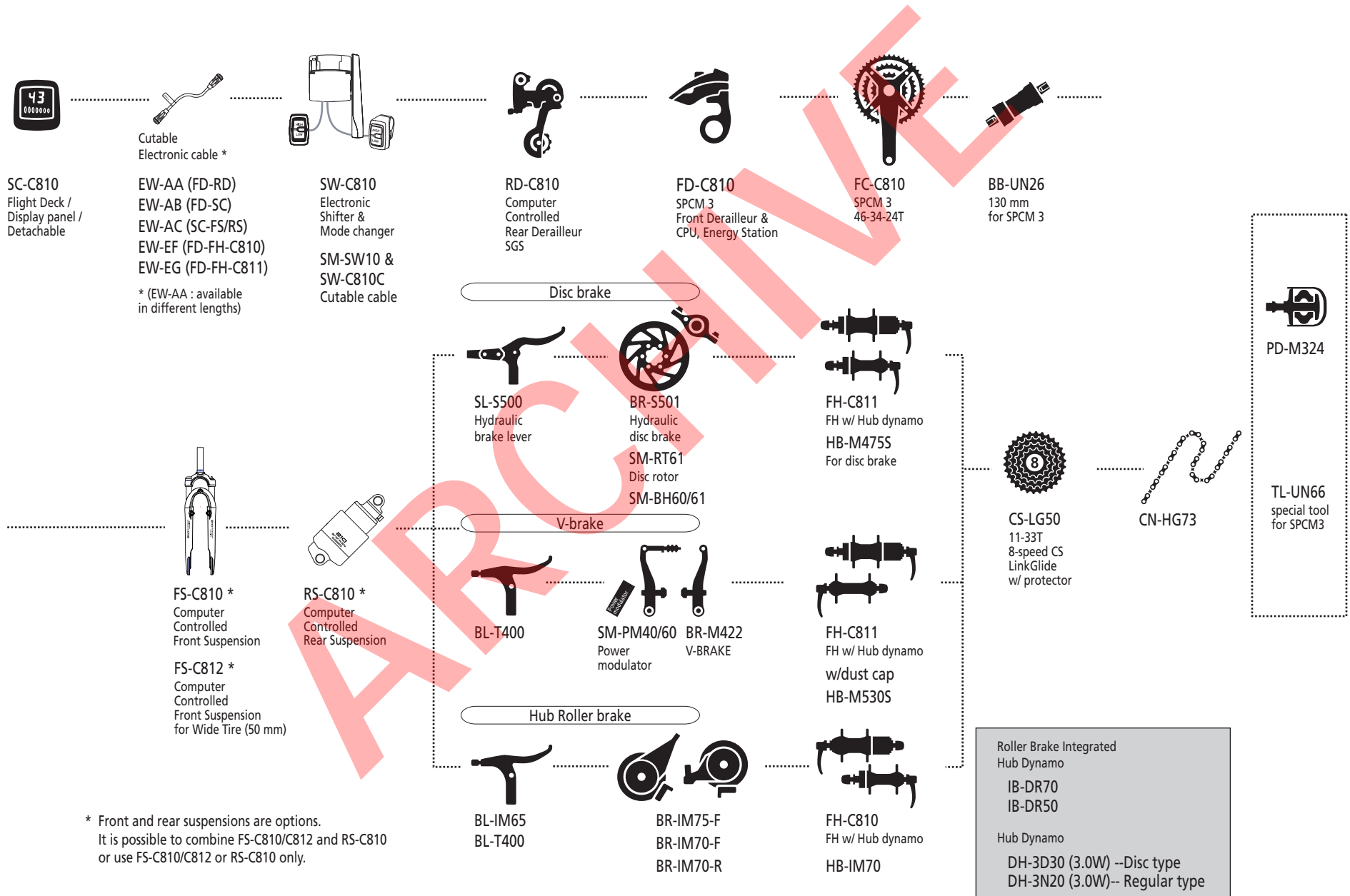

* Front and rear suspensions are options.
It is possible to combine FS-C810/C812 and RS-C810
or use FS-C810/C812 or RS-C810 only.

NEXAVE T300

FRONT HG 21-SPEED HUB ROLLER BRAKE

| | | | | | | | | | |
|-----------|-----------------------|----------------------------------------|------------------------------------------------|---------|------------------------------------------------------------------------------------|-----------------------------------------------------------------------------------------------------------------------------------------------|--------------------------------------|--------------------|--------------------|
| ST-T300-S | RD-T300 Low normal | FD-M190 CL: 47.5/50mm | FC-M191 Square 42T-34T-24T CL: 47.5mm | BB-UN26 | BR-IM77R BR-IM75-F BR-IM70-R Hub roller brake | HB-IM70 Power Modulator front hub FH-IM45 front hub roller brake | CS-HG3017 7-speed HG CS 11-28T | CP-FH56 For 32H | CN-HG50 CN-HG40 |
| BL-T400 | | FD-T301 for 48-38-28T CL: 47.5mm | FC-M191 Square 48-38-28T CL: 47.5mm | | BR-IM70-F Hub roller brake IB-DR70 Roll Brake Integrated Hub Dynamo | DH-3R30-NT DH-3R30-QR hub dynamo 6V - 3.0 W w/Power modulator DH-2R30-E (nut) hub dynamo 6V - 2.4 W w/Power modulator | | CP-FH53 For 36H | |

SM-SP18
SM-BT18

PD-M324

FRONT HG 21-SPEED V-BRAKE

| | | | | | | | | | |
|-----------|-----------------------|----------------------------------------|----------------------------------------------|----------------------------|------------------------------------------|------------------------------------------------------------------------|--------------------------------------|--------------------|--------------------|
| ST-T300-S | RD-T300 Low normal | FD-M190 CL: 47.5/50mm | FC-M191 Square 42-34-24T CL: 47.5mm | BB-UN26 <small>NEW</small> | BR-M422 SM-PM40/60 Power Modulator | FH-T300 Roller clutch HB-RM60QR | CS-HG3017 7-speed HG CS 11-28T | CP-FH56 For 32H | CN-HG50 CN-HG40 |
| | | FD-T301 for 48-38-28T CL: 47.5mm | FC-M191 Square 48-38-28T CL: 47.5mm | | | DH-3N20 hub dynamo 6V-3.0W DH-2N30-E hub dynamo 6V-2.4W | | CP-FH53 For 36H | |

TOURNEY series (3x7 speed)

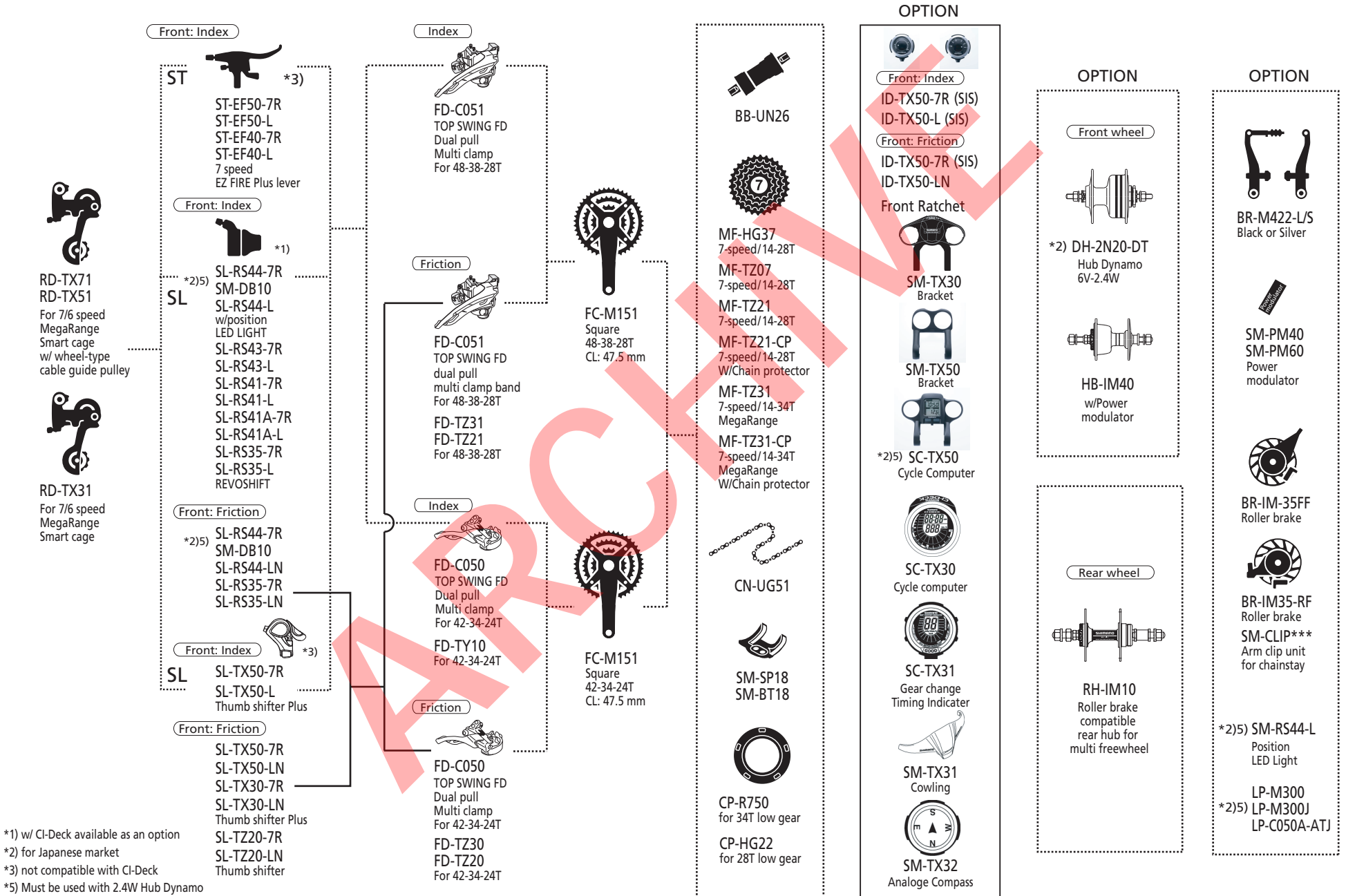

*1) w/ CI-Deck available as an option

*2) for Japanese market

*3) not compatible with CI-Deck

*5) Must be used with 2.4W Hub Dynamo

TOURNEY series (3x6 speed)

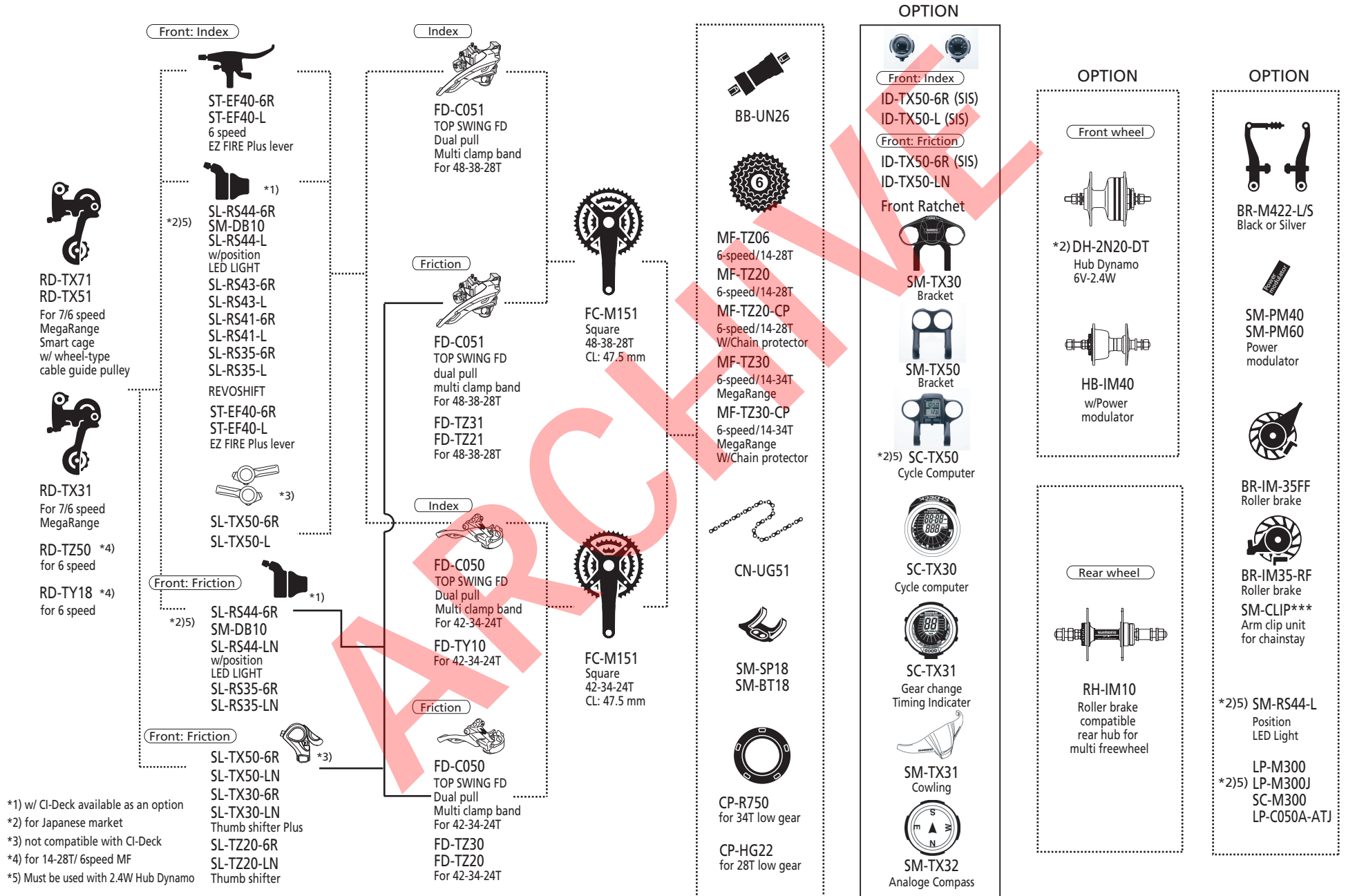

*1) w/ CI-Deck available as an option
 *2) for Japanese market
 *3) not compatible with CI-Deck
 *4) for 14-28T/ 6speed MF
 *5) Must be used with 2.4W Hub Dynamo

TOURNEY series (7 speed)



RD-TX71
RD-TX51
For 7/6 speed
MegaRange
Smart cage
w/ wheel-type
cable guide pulley



RD-TX31
For 7/6 speed
MegaRange



RD-FT30
for Single front
chainwheel only
w/ wheel-type
cable guide pulley
Max rear Sprocket: 28T
Total capacity: 17T

*2)5)  *1)
SL-RS44-7R
SM-DB10
SM-RS44-L
w/position
LED LIGHT

SL-RS43-7R
SL-RS41-7R
SL-RS41A-7R
SL-RS35-7R
REVOSHIFT

 *3)
SL-TX50-7R
SL-TX30-7R
Thumb shifter plus

SL-TZ20-7R
Thumb shifter



MF-HG37
7-speed/14-28T

MF-TZ07
7-speed/14-28T

MF-TZ21
7-speed/14-28T
W/Chain protector

MF-TZ21-CP
7-speed/14-28T
MegaRange

MF-TZ31-CP
7-speed/14-34T
MegaRange
W/Chain protector

CS-HG30-I
7-speed/11-28T



CN-UG51



SM-SP18
SM-BT18



CP-R750
for 34T low gear

CP-HG22
for 28T low gear



CN-UG51



SM-SP18
SM-BT18



CP-HG22
for 28T low gear

OPTION



Front: Index
ID-TX50-7R (SIS)
ID-TX50-L (SIS)



Front: Friction
ID-TX50-7R (SIS)
ID-TX50-LN

Front Ratchet



SM-TX30
Bracket



SM-TX50
Bracket



*2)5) SC-TX50
Cycle Computer



SC-TX30
Cycle computer



SC-TX31
Gear change
Timing Indicator



SM-TX31
Cowling



SM-TX32
Analogue Compass

OPTION

Front wheel

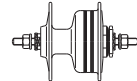

*2) DH-2N20-DT
Hub Dynamo
6V-2.4W

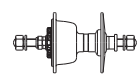

HB-IM40
w/Power
modulator

Rear wheel



RH-IM10
Roller brake
compatible
rear hub for
multi freewheel

FH-RM30-7NT

OPTION



BR-M422-L/S
Black or Silver



SM-PM40
SM-PM60
Power
modulator



BR-IM-35FF
Roller brake



BR-IM35-RF
Roller brake

SM-CLIP**
Arm clip unit
for chainstay

*2)5) SM-RS44-L
Position
LED Light

LP-M300
LP-M300J
SC-M300
LP-C050A-ATJ

*1) w/ CI-Deck available as an option *2) for Japanese market
*3) not compatible with CI-Deck *4) Must be used with 2.4W Hub Dynamo

TOURNEY series (6 speed)

- RD-TX71
RD-TX51
For 7/6 speed
MegaRange
Smart cage
w/ wheel-type
cable guide pulley
- RD-TX31
For 7/6 speed
MegaRange
- RD-FT30
for Single front
chainwheel only
w/ wheel-type
cable guide pulley
Max rear Sprocket: 28T
Total capacity: 17T
- RD-TY18 *4)
for 6 speed
- RD-TZ50 *4)
for 6 speed

*2)5) SL-RS44-6R
SM-DB10
SM-RS44-L
w/position
LED LIGHT

SL-RS43-6R
SL-RS41-6R
SL-RS35-6R
REVOSHIFT

*3)
SL-TX50-6R
SL-TX30-6R
Thumb shifter plus

SL-TY22-6R
SL-TZ20-6R
Thumb shifter

MF-TZ06
6-speed/14-28T

MF-TZ20
6-speed/14-28T

MF-TZ20-CP
6-speed/14-28T
W/Chain protector

MF-TZ30
6-speed/14-34T
MegaRange

MF-TZ30-CP
6-speed/14-34T
MegaRange
W/Chain protector



CN-UG51



SM-SP18
SM-BT18



CP-R750
for 34T low gear
CP-HG22
for 28T low gear



CN-UG51



SM-SP18
SM-BT18



CP-HG22
for 28T low gear

*1) w/ CI-Deck available as an option *2) for Japanese market
*3) not compatible with CI-Deck *4) for 14-28T/ 6speed MF
*5) Must be used with 2.4W Hub Dynamo

OPTION

Front: Index
ID-TX50-6R (SIS)
ID-TX50-L (SIS)

Front: Friction
ID-TX50-6R (SIS)
ID-TX50-LN

Front Ratchet

SM-TX30
Bracket

SM-TX50
Bracket

*2)5) SC-TX50
Cycle Computer

SC-TX30
Cycle computer

SC-TX31
Gear change
Timing Indicator

SM-TX31
Cowling

SM-TX32
Analogue Compass

OPTION

Front wheel

*2) DH-2N20-DT
Hub Dynamo
6V-2.4W

HB-IM40
w/Power
modulator

Rear wheel

RH-IM10
Roller brake
compatible
rear hub for
multi freewheel

OPTION

BR-M422-L/S
Black or Silver

SM-PM40
SM-PM60
Power
modulator

BR-IM-35FF
Roller brake

BR-IM35-RF
Roller brake
SM-CLIP**
Arm clip unit
for chainstay

*2)5) SM-RS44-L
Position
LED Light

LP-M300
*2)5) LP-M300J
SC-M300
LP-C050A-ATJ

DURA-ACE

20-SPEED

DURA-ACE

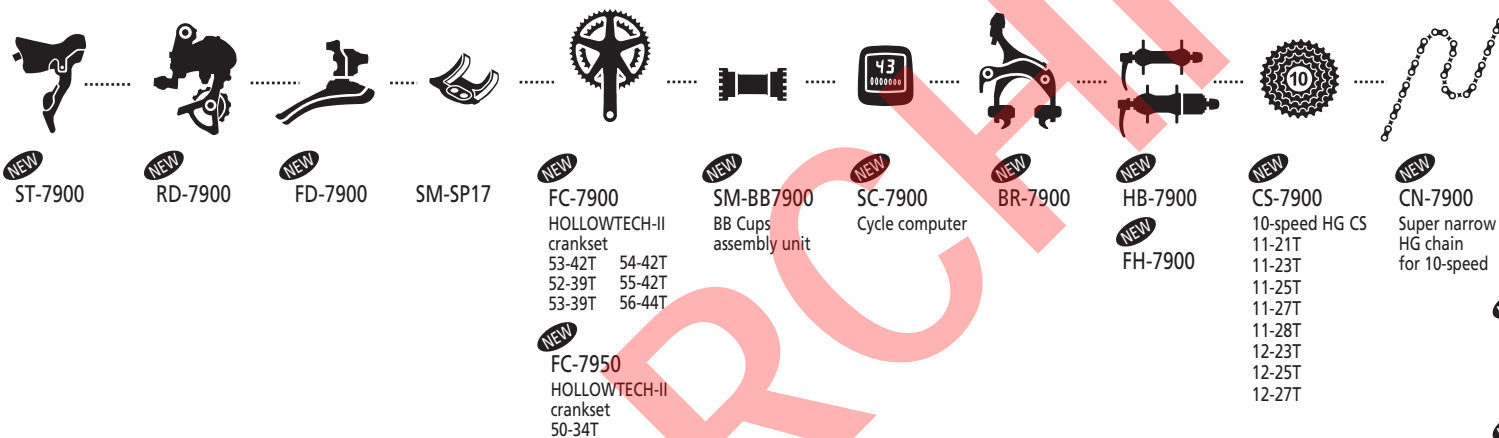

for 20-speed

- NEW SL-7900
- NEW SL-BS79
- NEW BL-TT79
Brake lever for Aero type bar

| | | |
|----------------------------------------------|----------------------------------------------------|------------------------------------------|
| HP-7410 | PD-7810 | |
| SIS-SP41 Shifting outer cable housing | WH-7850-C24-TU Carbon Wheel set | |
| | WH-7850-C50-CL 50mmdeep Carbon/Alloy Wheel set | CP-FH05 CP-FH06 CP-FH31 CP-FH35 |
| | WH-7850-C24-CL Carbon/Alloy Wheel set | NEW CP-FH08 |
| | WH-7850-C24-TL Carbon/Alloy Tubeless Wheel set | |
| | WH-7850-SL Scandium Alloy Tubeless Wheel set | |
| | WH-7850-C50-TU 50 mm deep Carbon Wheel set | |
| | CP-WH23 Spoke protector for WH-7850/ WH-RS10 | |
| DH-3N80 DH-3N72 Hub dynamo 6V-3.0W | | |
| NEW DH-2N80 DH-2N72 Hub dynamo 6V-2.4W | | |

SHIMANO ULTEGRA

20-SPEED



SL Series (Ice Gray Version)

ST-6600G RD-6600G-SS FD-6600G SM-SP17 FC-6601G (SM-FC6601) BR-6600G

HOLLOWTECH-II
w/BB cup unit
52-39T/53-39T

BB cups
assembly unit

FC-6650G
HOLLOWTECH-II
w/BB cup unit
50-34T

Silver version

ST-6600 RD-6600-SS FD-6600 SM-SP17 FC-6600 (SM-FC6600) BR-6600

HOLLOWTECH-II
w/BB cup unit
52-39T/53-39T

BB cups
assembly unit

FC-6650
HOLLOWTECH-II
w/BB cup unit
50-34T

30-SPEED



SL Series (Ice Gray Version)

ST-6603G RD-6600G-GS FD-6603G SM-SP17 FC-6604G (SM-FC6601) BR-6600G

HOLLOWTECH-II
w/BB cup unit
52-39-30T

BB cups
assembly unit

FC-6603
HOLLOWTECH-II
w/BB cup unit
52-39-30T

Silver version

ST-6603 RD-6600-GS FD-6603 SM-SP17 FC-6603 (SM-FC6600) BR-6600

BB cups
assembly unit

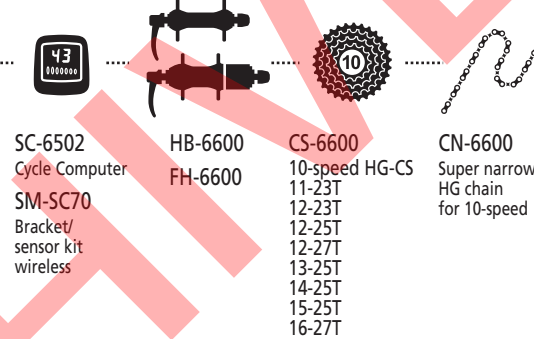

SC-6502
Cycle Computer
SM-SC70
Bracket/
sensor kit
wireless

HB-6600
FH-6600

CS-6600
10-speed HG-CS
11-23T
12-23T
12-25T
12-27T
13-25T
14-25T
15-25T
16-27T

CN-6600
Super narrow
HG chain
for 10-speed



HP-6500



PD-6620
PD-6620G

SIS-SP41
shifting outer
cable housing



DH-3N80
DH-3N72
Hub Dynamo
6V-3.0W

DH-2N80
DH-2N72
Hub Dynamo
6V-2.4W



WH-6600
WH-6600G
Ultegra logo

WH-R601
Shimano logo
CP-WH20-A

CP-FH05
CP-FH06
CP-FH31
CP-FH35

for 20/30 speed

SL-7800 BL-R600
SL-BS78

for 20-speed flat handlebar bicycle

SL-R770 FD-R770
BL-R770

for 20-speed

FC-R700
HOLLOWTECH-II
w/BB cup unit
50-34T

BR-R650
Long reach
Caliper brake



BR-R505
Disc brake
Center Lock
rotor mount



HB-R505



For Disc brake
Center Lock
rotor mount
OLD:135mm
(Refer to technical information)

NEW BL-TT78
Brake lever for
Aero type bar

for 30-speed flat handlebar bicycle
SL-R770 FD-R773-2 for 52-39-30T
BL-R770

BR-R550 *
Cantilever
brake
* Linkwire should be ordered separately.
A-LWTYPE (59.5mm)
A-LWZTYF (64.5mm)



SM-RT62
Center Lock
mount rotor

SHIMANO 105

20-SPEED



Black Version

NEW ST-5600-L **NEW** RD-5600-L-SS **NEW** FD-5600-L SM-SP17 **NEW** FC-5600-L
 HOLLOWTECH-II w/BB cup unit 52-39T/50-39T/53-39T (SM-FC5600) BB cups assembly unit **NEW** BR-5600-L **NEW** HB-5600-L
NEW FH-5600-L

Silver Version

ST-5600 RD-5600-SS FD-5600 SM-SP17 FC-5600 (SM-FC5600) BR-5600 HB-5600
 FC-5650 FH-5600

30-SPEED



Black Version

NEW ST-5600-IRD-5600-L-GS **NEW** FD-5603-L For FC-5603 (50-39-30T) SM-SP17 **NEW** FC-5603-L
 HOLLOWTECH-II w/BB cup unit 50-39-30T (SM-FC5600) BB cups assembly unit **NEW** BR-5600-L **NEW** HB-5600-L
NEW FH-5600-L

Silver Version

ST-5600 RD-5600-GS FD-5603 SM-SP17 FC-5603 (SM-FC5600) BR-5600 HB-5600
 FH-5600

NEW SC-6502 Cycle Computer
NEW SM-SC70 Bracket/sensor kit wireless

NEW CS-5600 10-speed HG CS 11-23T 11-25T 12-25T 12-27T

NEW CN-5600 Super narrow HG chain for 10-speed

NEW SIS-SP41 Shifting outer cable housing

NEW DH-3N80 Hub dynamo 6V-3.0W

NEW DH-3N72 Hub dynamo 6V-2.4W

NEW DH-2N80 Hub dynamo 6V-3.0W
NEW DH-2N72 Hub dynamo 6V-2.4W

NEW PD-5610 SPD-SL pedal
NEW PD-A530 SPD pedal
NEW PD-A520 SPD pedal

NEW WH-RS30 Shimano logo Wheel set
NEW WH-RS20 Shimano logo Wheel set
NEW WH-RS10 Shimano logo Wheel set

NEW CP-WH23 Spoke protector for WH-7850/WH-RS10/20/30

NEW CP-FH05
NEW CP-FH06
NEW CP-FH31
NEW CP-FH35
NEW CP-FH08

for 20/30 speed
 SL-7800 BL-R600
 SL-B578

for 20-speed flat handlebar bicycle
 SL-R770 FD-R770
 BL-R770

for 30-speed flat handlebar bicycle
 SL-R770 FD-R773-0 for 50-39-30T
 BL-R770

for 20-speed
NEW FC-R700 HOLLOWTECH-II w/BB cup unit 50-34T

for 20-speed
NEW FC-R600 2-piece Crank Arm 50-34T

for 20-speed
 FC-R550 2-piece Crank Arm 52-39T/53-39T/50-39T

for 30-speed
 FC-R553 2-piece Crank Arm 50-39-30T

BR-R505 Disc brake Center Lock rotor mount

SM-RT62 Center Lock mount rotor

BR-R650 Long reach Caliper brake

BR-R560 Short reach Caliper brake

HB-R505 FH-R505 For Disc brake Center Lock rotor mount OLD:135 mm (refer to technical information)

NEW BR-R550 * Cantilever brake
 * Linkwire should be ordered separately.
 A-LWTYPE (59.5mm)
 A-LWZYF (64.5mm)

SHIMANO TIAGRA

18-SPEED



ST-4500 RD-4500-SS FD-4500 SM-SP17 FC-4500 (52-39T) (SM-FC4500)
FC-4550 (50-34T)
2-piece Crank Arm

SL-7700 BL-R400
SL-BS77

For flat handle bar



SL-R440 BL-R550 FD-R440

FC-4550-S
w/Shimano logo
2-piece Crank Arm
50-34T

27-SPEED

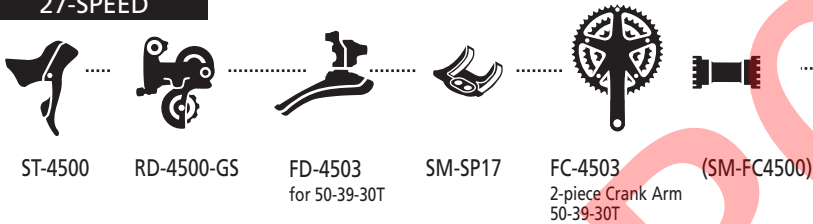

ST-4500 RD-4500-GS FD-4503 for 50-39-30T SM-SP17 FC-4503 (SM-FC4500)
2-piece Crank Arm
50-39-30T

SL-BS77 BL-R400

FD-4503
for 52-42-30T

For flat handle bar



SL-R440 BL-R550 FD-R453 for 50-39-30T
FD-R443 for 52-42-30T



BR-4500

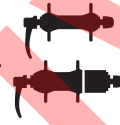

HB-4500
FH-4500

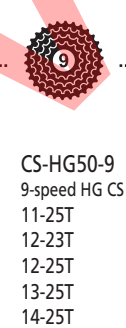

CS-HG50-9
9-speed HG CS
11-25T
12-23T
12-25T
13-25T
14-25T



CN-HG53
Super narrow
HG chain

NEW

DH-3N80
DH-3N72
Hub Dynamo
6V-3.0 W

NEW

DH-2N80
DH-2N72
Hub Dynamo
6V-2.4W



PD-R540
SPD-SL pedal

PD-A530
SPD-SL pedal

PD-A520
SPD pedal



WH-RS10
wheel set

CP-WH23

WH-R500A

WH-R500
CP-FH02
for 21-25T
CP-FH35
for 27T

CP-FH05
CP-FH06
CP-FH31
CP-FH35

BR-R505
Disc brake



SM-RT63
Center Lock
mount rotor

BR-R450
long reach
w/Shimano logo



BR-R550 *
Cantilever
brake



HB-R505

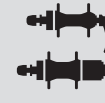

FH-R505



For Disc brake
Center Lock
rotor mount
OLD: 135mm
(Refer to technical information)

*Linkwire should be ordered separately.
A-LWTYPE (59.5mm)
A-LWZTYF (64.5mm)

SHIMANO SORA

18-SPEED

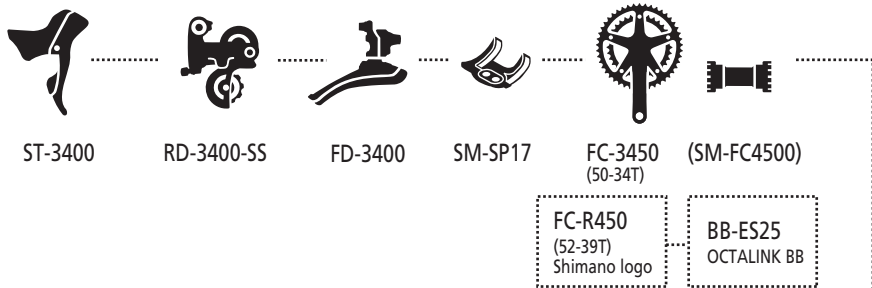

SL-R400 BL-R400

For flat handle bar



27-SPEED

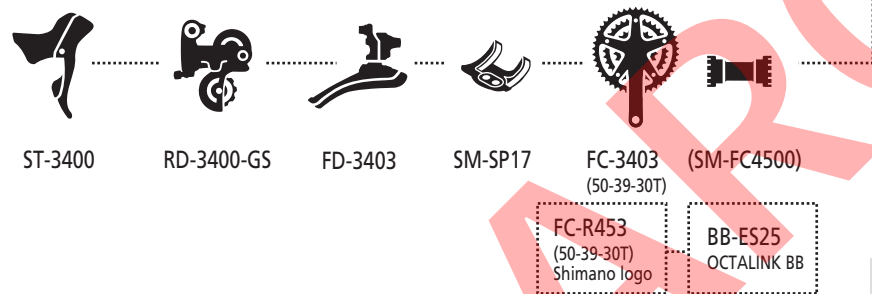

SL-R400 BL-R400 FD-4403 (for 52-42-30T)

For flat handle bar

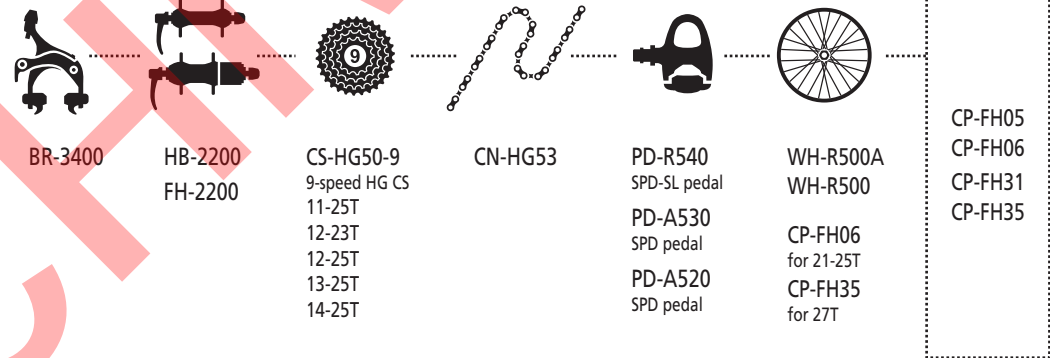

BR-R450 long reach w/Shimano logo



BR-R550 * Cantilever brake



* Linkwire should be ordered separately.
A-LWTYPE (59.5mm)
A-LWZTYF (64.5mm)

2200

16-SPEED

For drop handle bar



For down tube shift

SL-R400-----BL-R400

For flat handle bar
16-SPEED

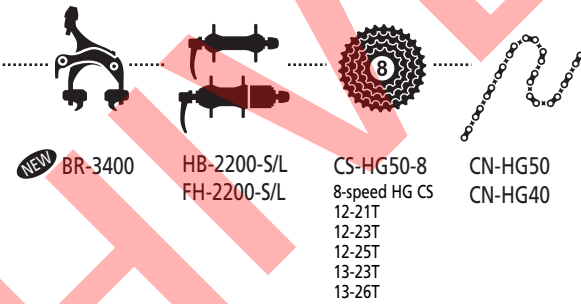
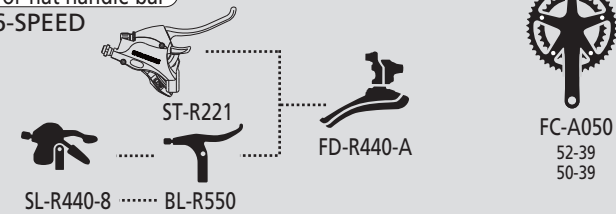

PD-R540
SPD-SL pedal

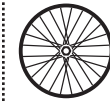

WH-R500
Complete
wheel

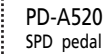

PD-A520
SPD pedal

CP-FH06
for 21-25T
CP-FH35
for 27T

CP-FH05
CP-FH06
CP-FH31
CP-FH35

24-SPEED

For drop handle bar



For flat handle bar
24-SPEED

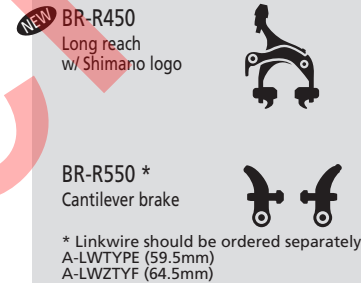
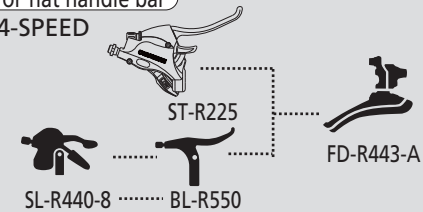

A050

14-SPEED

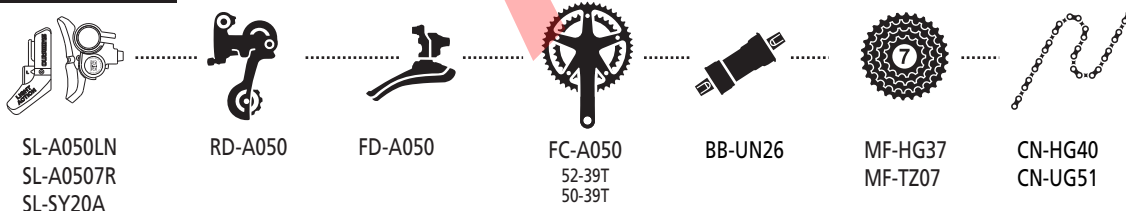

CAPREO

wheel size :20inch max.

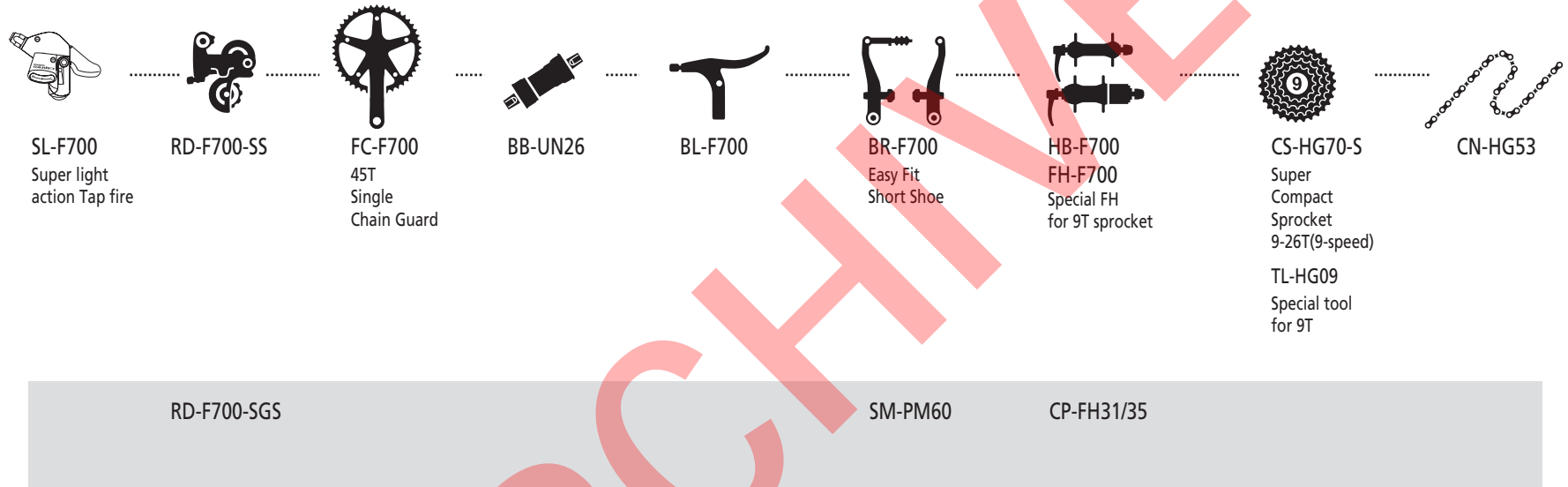

ALFINE

Vertical drop end use



CT-S500
Chain tensioner



FC-S500
2 pcs crank set
w/BB unit
45T or 39T
Double chain guard

FC-S400
OCTALINK
45T or 39T
Double chain guard



SL-S500
Rapidfire-plus
shifter

NEW SG-S501
For disc brake use
Centerlock mount



BL-S500
Hydraulic disc
BL
4-finger

BL-S502
Hydraulic disc
BL
2.5-finger

NEW BR-S501
Brake caliper



NEW SM-RT64
Disc rotor
Centerlock mount



SM-BH59
Hydraulic brake hose

NEW DH-S501
Hub dynamo
6V-3.0W
For disc brake use
Centerlock mount



Auto-L
Compatible lamp



CN-HG53



PD-A530
SPD pedal



NEW WH-S501-3D
Trekking use
Disc brake
w/Hub dynamo
for front

NEW WH-S501-8D
Trekking use
Disc brake
w/Internal 8-speed
for rear

NEW WH-S501-V-3D
Trekking use
V-BRAKE/ Disc
w/hub dynamo
for front

NEW WH-S501-V
Trekking use
V-BRAKE / Disc
for front

NEW WH-S501-V-8D
Trekking use
V-BRAKE/ Disc
w/Internal 8-speed
for rear

Track drop end use



FC-S500
2 pcs crank set
w/BB unit
45T or 39T
Single chain guard

FC-S400
OCTALINK
45T or 39T
Single chain guard

CN-NX10

Cyber Nexus (Nexus Di2)

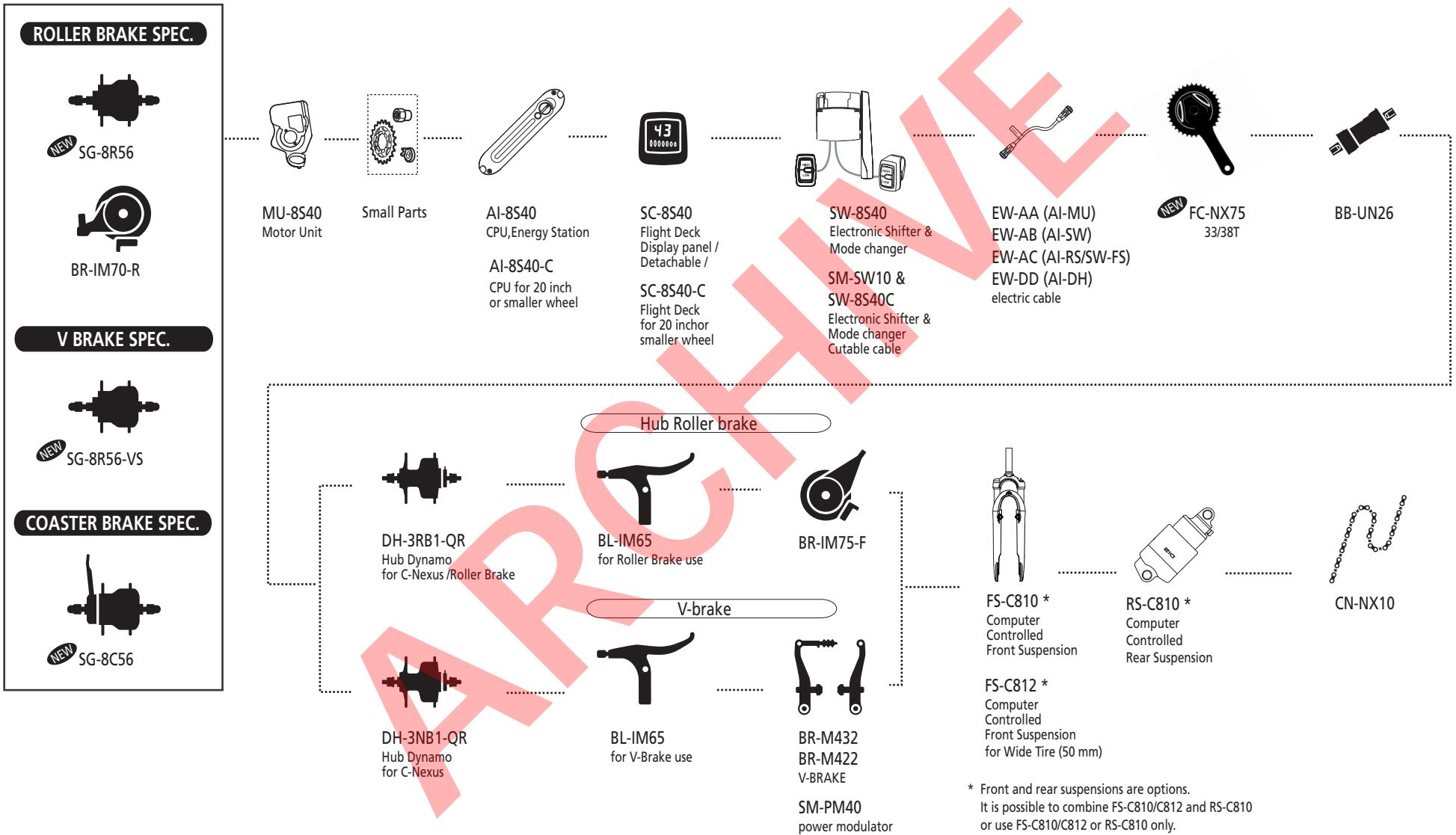

NEXUS INTER-8

ROLLER BRAKE SPEC.

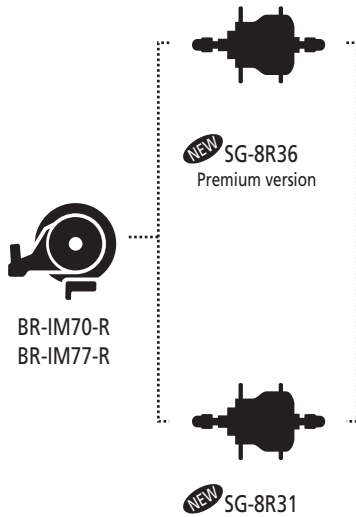

V BRAKE SPEC.

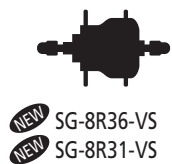

COASTER BRAKE SPEC.

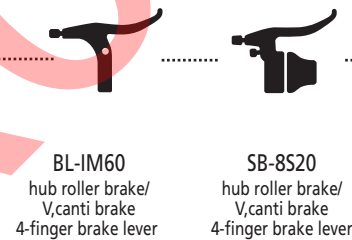
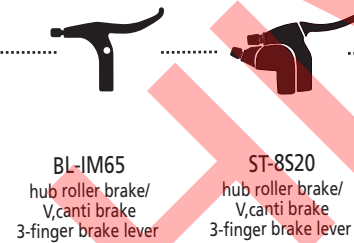
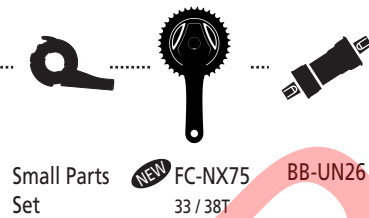

ROLLER BRAKE SPEC.

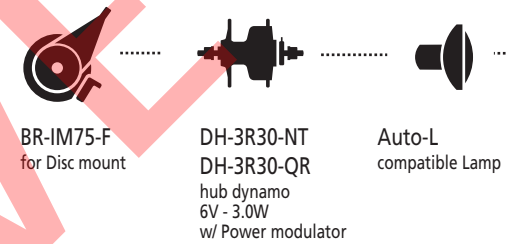

*refer to technical information for selection

V BRAKE SPEC.

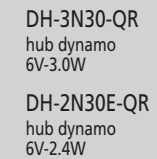
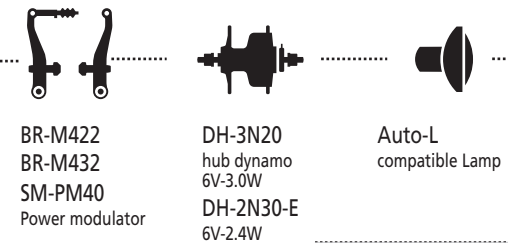

NEXUS INTER-7

ROLLER BRAKE SPEC.



BR-IM77-R
BR-IM57-R
BR-IM50-R
BR-IM41-R

COASTER BRAKE SPEC.



SG-7C18
(Steel Hub Shell)
made in Czech

V BRAKE SPEC.



Small parts
Left hand dust cap

ROLLER BRAKE SPEC.



BL-IM45
hub roller brake use

SB-7S45
hub roller brake use



BL-IM65
hub roller brake use

SL-7S20
SL-7S10

V BRAKE SPEC.



BL-IM65
V-brake use

SL-7S20
SL-7S10



BR-IM75-F



DH-3R30-NT
DH-3R30-QR
hub dynamo
6V-3.0W
w/Power modulator



Auto-L
compatible Lamp

IB-DR70
IB-DR50
Roll Brake
Integrated Hub

DH-2R30-E
hub dynamo
6V-2.4W
w/Power modulator

BR-IM70-F
BR-IM50-F
BR-IM41-F

HB-IM70
HB-IM40
w/Power modulator

*refer to technical information for selection

BL-IM45
V-brake use

SB-7S45
V-brake use

DH-3N30-QR
hub dynamo
6V-3.0W

DH-2N30E-QR
hub dynamo
6V-2.4W



CN-NX10



HP-NX10

NEXUS AUTO-D w/Inter-3

ROLLER BRAKE SPEC.



BR-IM41R



SG-3R40

COASTER BRAKE SPEC.



SG-3C41

V BRAKE SPEC.



Small parts
Left hand dust cap



SG-3R40



Small Parts Set



NEW FC-NX75
33 / 38T



BB-UN26

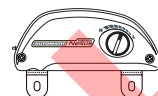

AI-3S30
LS-AI3S30
EW-AI3S30

ROLLER BRAKE SPEC.



DH-3RB1-QR



BL-IM65
Hub roller brake use



BR-IM75-F
for Disc mount



Lamp
w/o Auto light
Sensor

COASTER / V BRAKE SPEC.



DH-3NA1
for AI-3S30



BL-IM65
V-brake use

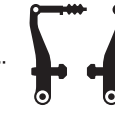

BR-M432
BR-M422
w/ Power modulator
SM-PM40



Lamp
w/o Auto light
Sensor



CN-NX10



HP-NX10

NEXUS INTER-3

ROLLER BRAKE SPEC.



BR-IM41-R



SG-3R40

COASTER BRAKE SPEC.



SG-3C41



Small Parts Set



NEW FC-NX75
33 / 38T



BB-UN26

V BRAKE SPEC.



Small parts
Left hand dust cap



SG-3R40

ROLLER BRAKE SPEC.



BL-IM65
hub roller brake/
V, canti brake
3-finger brake lever



SL-3S41E*
SL-3S42E*
SL-3S35-E



BR-IM41-F



DH-3R30-NT
DH-3R30-QR
hub dynamo
6V - 3.0W
w/ Power modulator



Auto-L
compatible Lamp

BR-IM70-F
BR-IM50-F

DH-2R30-E
hub dynamo
6V - 2.4W
w/ Power modulator

HB-IM70
HB-IM40
w/ Power modulator

*refer to technical information for selection



CN-NX10



HP-NX10

V BRAKE SPEC.



BL-IM65
V-brake use



SL-3S41E*
SL-3S42E*
SL-3S35-E



BR-M432
BR-M422
SM-PM40
Power modulator



DH-3N20
hub dynamo / 6V-3.0W
DH-2N30-E
hub dynamo / 6V-2.4W



Auto-L
compatible Lamp

HB-3N30-QR
hub dynamo / 6V-3.0W
HB-2N30E-QR
hub dynamo / 6V-2.4W

*SL-3S41E: Short Grip

*SL-3S42E: Long Grip