

**ARCHIVE**

This information was updated on April 15, 2026. SHIMANO makes no warranty with respect to this information, including without limitation any warranty on the accuracy of measures, specifications and compatibility of the current products. Regarding any modification and new product information after April 15, 2026, please refer to the SHIMANO Business Customer Web Site or directly contact the sales person of our company.

**SHIMANO**

**2025-2026**

**Products compatibility Information**

Compatibilities are subject to change without prior

**Visit SHIMANO PRODUCT WEBSITE for the latest information.**

# Word definitions

<b>BB</b>	Bottom bracket	<b>HRB, BR</b>	Roller brake
<b>BC</b>	Brake outer casing	<b>I-SPEC</b>	Integration mounting system of brake lever and shifter
<b>BCC</b>	Charger cord		
<b>BCR, EC</b>	Battery charger	<b>ID</b>	CI-DECK
<b>BH</b>	Brake hose	<b>JC</b>	Junction
<b>BL</b>	Brake lever	<b>LP</b>	Light
<b>BM</b>	Battery mount	<b>MF</b>	Multiple freewheel
<b>BR</b>	Brake caliper	<b>MU</b>	Motor unit
<b>BTC</b>	Battery case	<b>O.L.D.</b>	Over Locknut Dimension
<b>BT, BTR</b>	Battery	<b>OT</b>	Shift outer casing
<b>CB</b>	Coaster brake	<b>P.C.D.</b>	Pitch Circle Diameter
<b>CC, EWC</b>	Wire cover	<b>PCE</b>	PC linkage device
<b>CD</b>	Chain device	<b>PD</b>	Pedal
<b>CG</b>	Chain guard	<b>PM</b>	POWER MODULATOR
<b>CJ</b>	Cassette joint	<b>QR</b>	Quick release
<b>CN</b>	Chain	<b>RD</b>	Rear derailleur
<b>CP</b>	Spoke protector	<b>RT, SMRT</b>	Rotor
<b>CR</b>	Chainring	<b>RTAD</b>	Rotor adapter
<b>CS</b>	Cassette	<b>SB</b>	REVOSHIFT shifter integrated with brake lever
<b>CT</b>	Chain tensioner	<b>SC</b>	Cycle computer, System information display
<b>DH</b>	Hub dynamo	<b>SF</b>	Single freewheel
<b>DU</b>	Drive unit	<b>SG</b>	Internal geared hub
<b>EW</b>	Electric wire	<b>SL</b>	Shifter
<b>EWCP</b>	Satellite charging port	<b>SPD</b>	SHIMANO PEDALING DYNAMICS
<b>EWEX</b>	Di2 adapter, CAN adapter	<b>SPD-SL</b>	SHIMANO PEDALING DYNAMICS-SL
<b>EWSW</b>	Satellite system ON/OFF switch	<b>ST</b>	DUAL CONTROL LEVER : Shifter integrated with brake lever
<b>EWV, WU</b>	Wireless unit	<b>SW</b>	Shift switch, Switch unit, Satellite shifter
<b>FC</b>	Crankset, Crank arm	<b>WH</b>	Wheel
<b>FD</b>	Front derailleur		
<b>FH</b>	FREEHUB		
<b>GM</b>	Grommet		
<b>HB</b>	Front hub		
<b>HP</b>	Head parts		

# Model no. color definitions

<u>XX-####</u>	New models
XX-####	Current line-up models
XX-####	Discontinued models

Status of each product may vary depending on the distribution status of the products and the timing of this document's updates.

ARCHIVE

# Compatibility

## Drivetrain for MTB, LIFESTYLE components C-432

Rear drivetrain compatibility [MTB, LIFESTYLE]

C-433 C-434 C-558 C-780 C-435 C-436 C-437 C-438  
C-439 C-546

Front drivetrain compatibility [MTB, Trekking, LIFESTYLE]

C-440 C-559 C-441 C-442 C-445 C-446

Front derailleur and crankset

C-447

Front derailleur and chain line (TOURNEY)

C-448

Crankset, bottom bracket and chain line [MTB, LIFESTYLE]

C-449 C-450

## Drivetrain for ROAD, Gravel, LIFESTYLE components C-453

9, 10, 11, 12-speed rear drivetrain compatibility

C-806

Rear drivetrain compatibility

C-454

Front drivetrain compatibility

C-455

## Brake system for ROAD, Gravel, LIFESTYLE components C-737

Brake systems compatibility [ROAD, LIFESTYLE]

C-456

Hydraulic systems compatibility [ROAD, Gravel]

C-499

Hydraulic systems compatibility [URBAN, LIFESTYLE]

C-500

Compatibility of BL-U8000 with shifter

C-738

Compatibility of BL-UR405 with shifter

C-755

## I-SPEC C-156

Compatibility of I-SPEC shifter and brake lever

C-157

Compatibility of Shift Switch and I-SPEC brake lever

C-744

## Disc brake C-460

SHIMANO brake oil compatibility	C-736
Disc brake caliper and rotor compatibility	C-461
Compatibility of lock ring with hubs	C-612
Compatibility between brake systems (MT400 series)	C-606
Combination chart (mechanical disc brake)	C-462 C-463 C-464
Compatibility between hydraulic disc brake hose	C-186 C-732 C-733
Compatibility between banjo screw	C-625
Brake pad line-up	C-192 C-652 C-653
Disc brake mount adapter	C-193 C-194 C-195

## Rim brake C-200

Brake / Shoe line-up	C-201
Brake shoe recommendation to rim width	C-202

## Cable System C-605

Polymer-coated brake cable (BC-9000 / BC-R680) compatible chart	C-306
---	-------

## V-BRAKE and Roller brake C-465

Compatibility between brake systems	C-466
Brake lever with switch compatibility	C-467 C-468 C-469

## Cassette C-544

FREEHUB and cassette spline compatibility	C-731
7-speed rear derailleur and FREEHUB compatibility	C-817
Compatibility between rear derailleur and cassette gear teeth [ROAD, Gravel, METREA]	C-254 C-648 C-255 C-256 C-257 C-258 C-259
LINKGLIDE cassette and FREEHUB compatibility	C-649

## ALFINE, NEXUS components C-470

Available combinations of the dropout, sprocket and crankset for designing the frame C-471

Mechanical internal geared hub / SM (CJ) COMPATIBILITY CHART C-647

Sprocket and chain combination C-608

## CARGO BIKE related components C-651

Compatibility for DIN 79010:2020-02 C-672

## Spoke protector C-298

Spoke protector C-491

MTB, Gravel, LIFESTYLE C-299

ROAD, Gravel, METREA C-300

Spoke protector for Road C-302

## E-BIKE compatibility chart C-431

Compatibility chart of E-TUBE PROJECT Cyclist/Professional v5.4.4 C-525

Drivetrain compatibility C-488 C-706 C-656 C-657 C-658 C-659

Switch unit / cycle computer and brake lever compatibility C-421

Battery and battery mount compatibility C-511

System on/off function compatibility C-629

Configuration of assist switch functions C-781

Speed sensor compatibility C-549

Battery and battery charger compatibility C-562

ABS compatibility C-715 C-774 C-775

Crank arm for 3rd party E-BIKE system C-783

## Electronic Product Information C-472

Compatibility chart of E-TUBE PROJECT Cyclist/Professional v5.4.4

C-473

Di2 compatibility for 3rd party E-BIKE system

C-429

## CI-DECK C-547

Compatibility between Bracket and ID/SC

C-548

ARCHIVE

## Rear drivetrain compatibility [MTB, LIFESTYLE]

C-433

### 9,10,11-speed rear drivetrain compatibility C-434

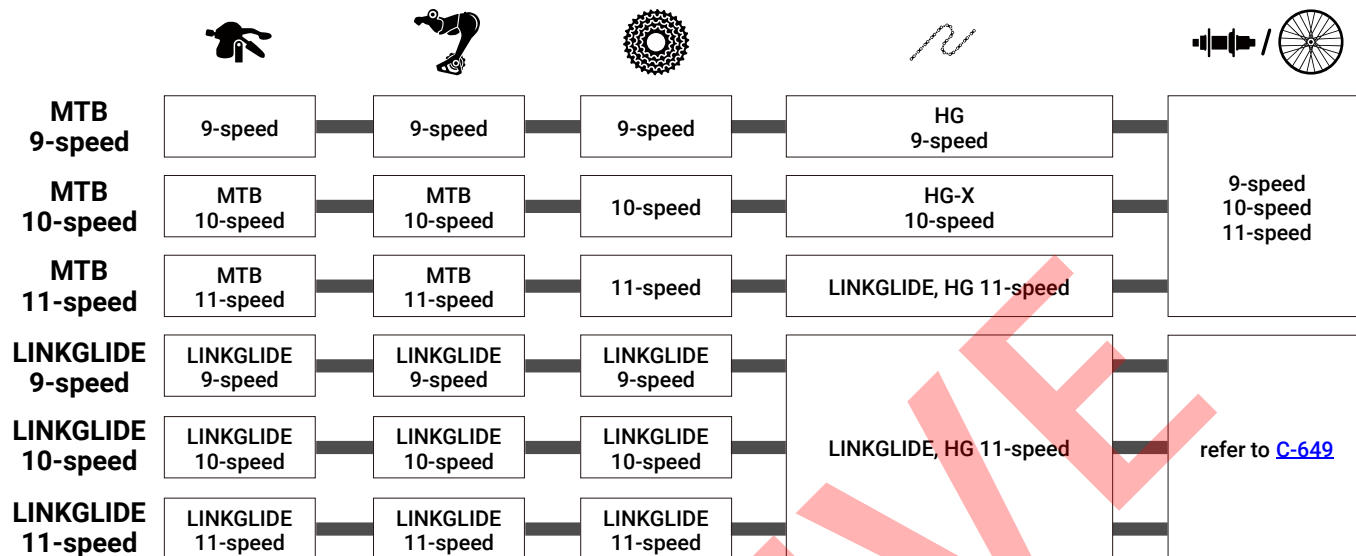

# 12-speed rear drivetrain (MICRO SPLINE) [MTB] C-558

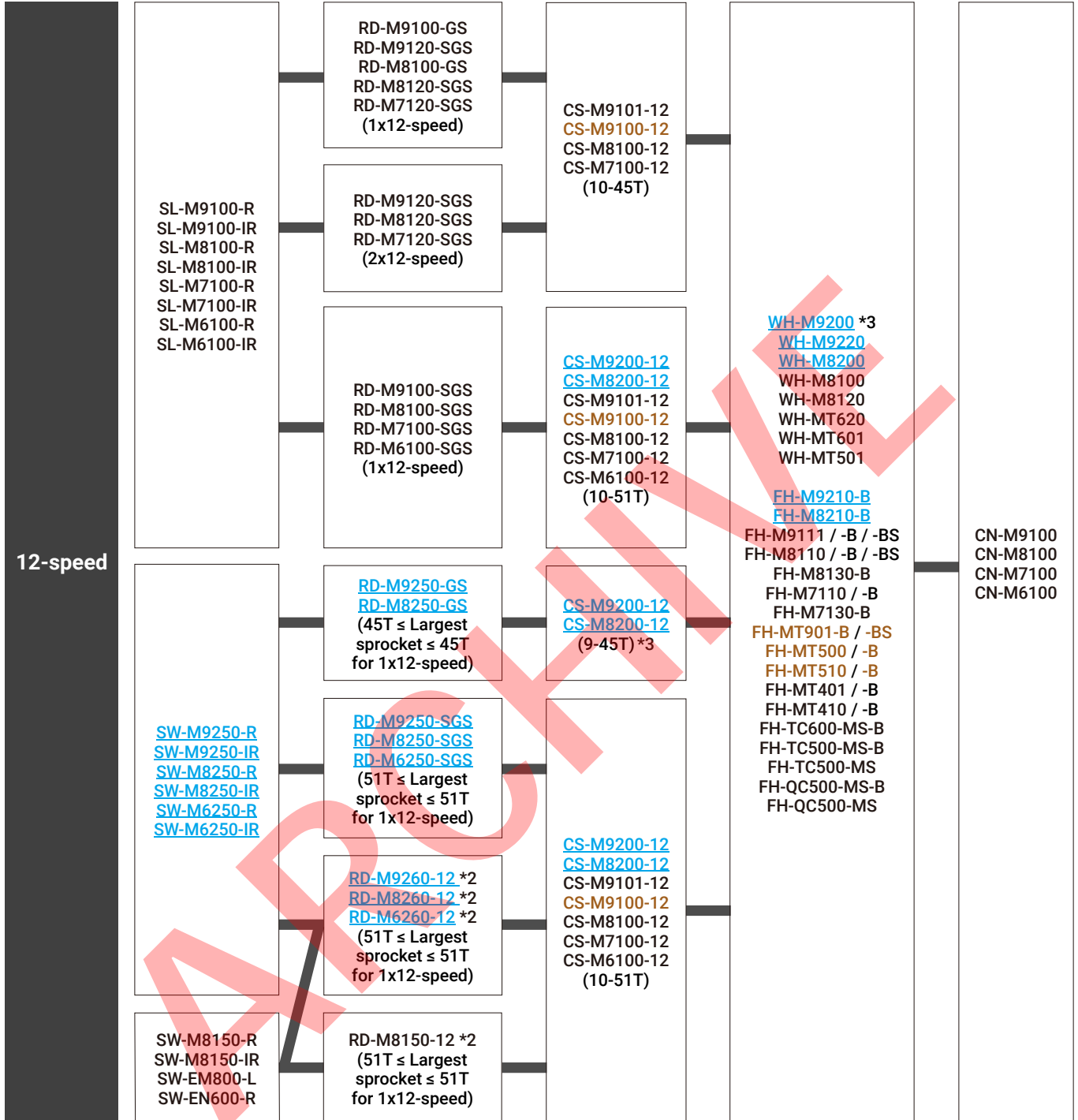
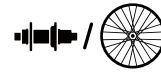

\*1 Method to adjust the end adjustment screw is different from conventional rear derailleurs. For details, refer to dealer's manual.

\*2 Only for E-BIKE

\*3 Do not use for E-BIKE

## Front x Rear drivetrain compatibility for 12-speed [MTB] C-780

[RD-M9250](#) / [RD-M8250](#) / [RD-M6250](#) are compatible with all crankset for 12-speed with 55 mm chain line.



**MTB  
Rear derailleur for  
12-speed**

[RD-M9250-SGS](#)  
[RD-M9250-GS](#)  
[RD-M8250-GS](#)  
[RD-M8250-SGS](#)  
[RD-M6250-SGS](#)



**MTB  
Crankset for 12-speed  
drivetrain with 55mm chain  
line**

[FC-M9200](#)  
[FC-M9220](#)  
[FC-M8200](#)

FC-M9125  
FC-M8120  
FC-M7120  
FC-M6120  
FC-MT512

ARCHIVE

# 11-speed rear drivetrain [MTB, LIFESTYLE] C-435

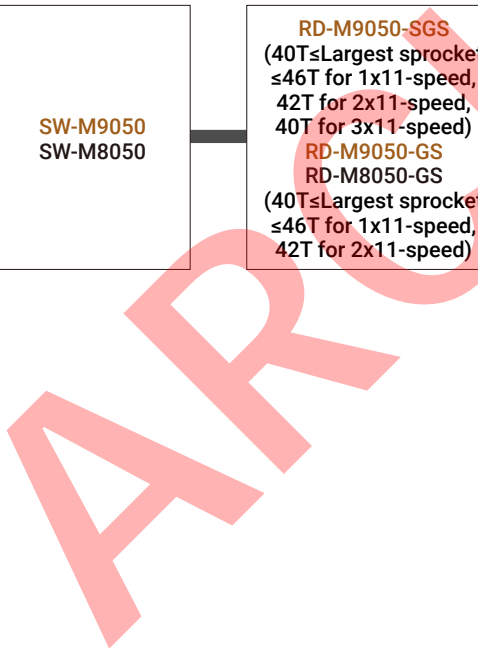
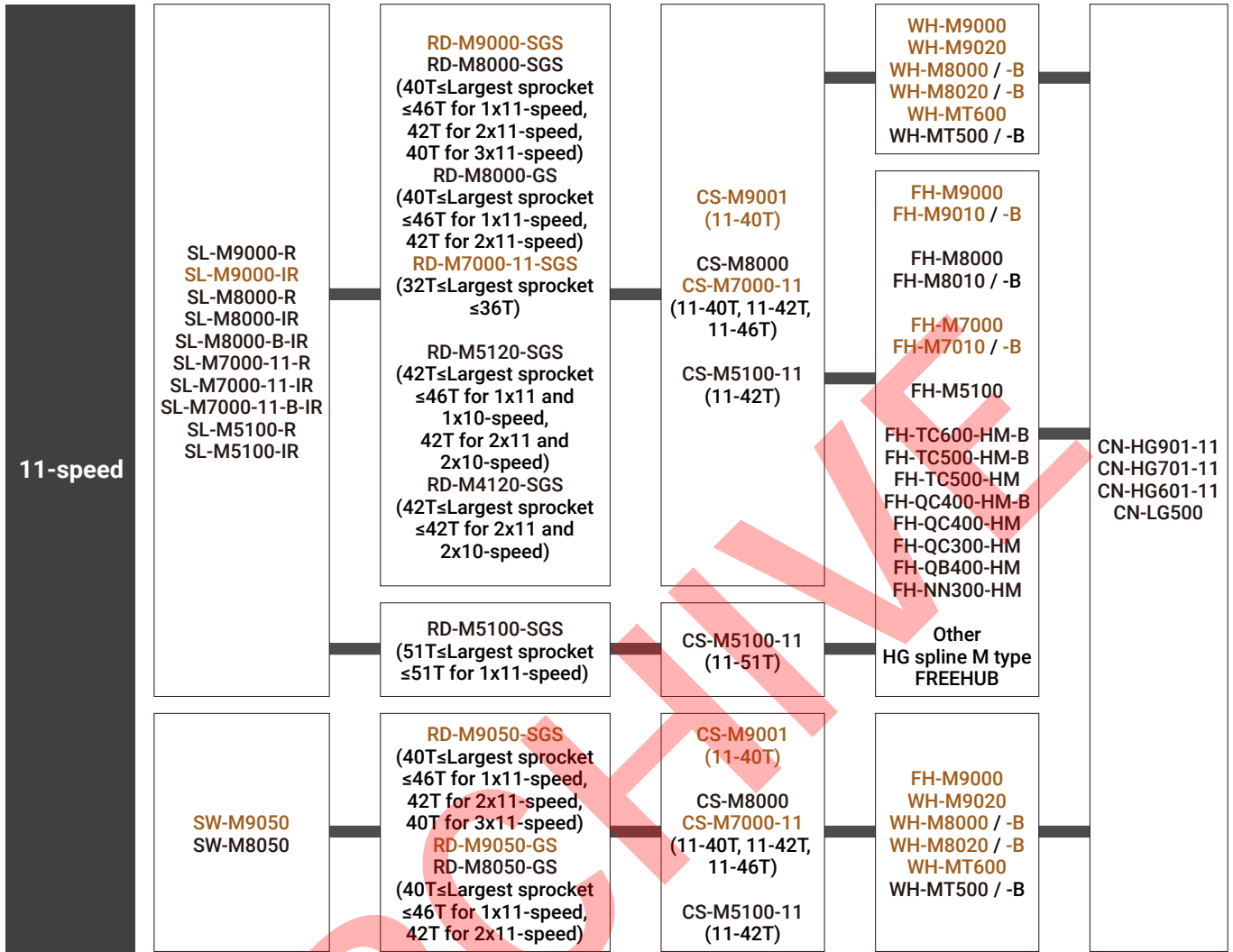
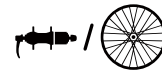

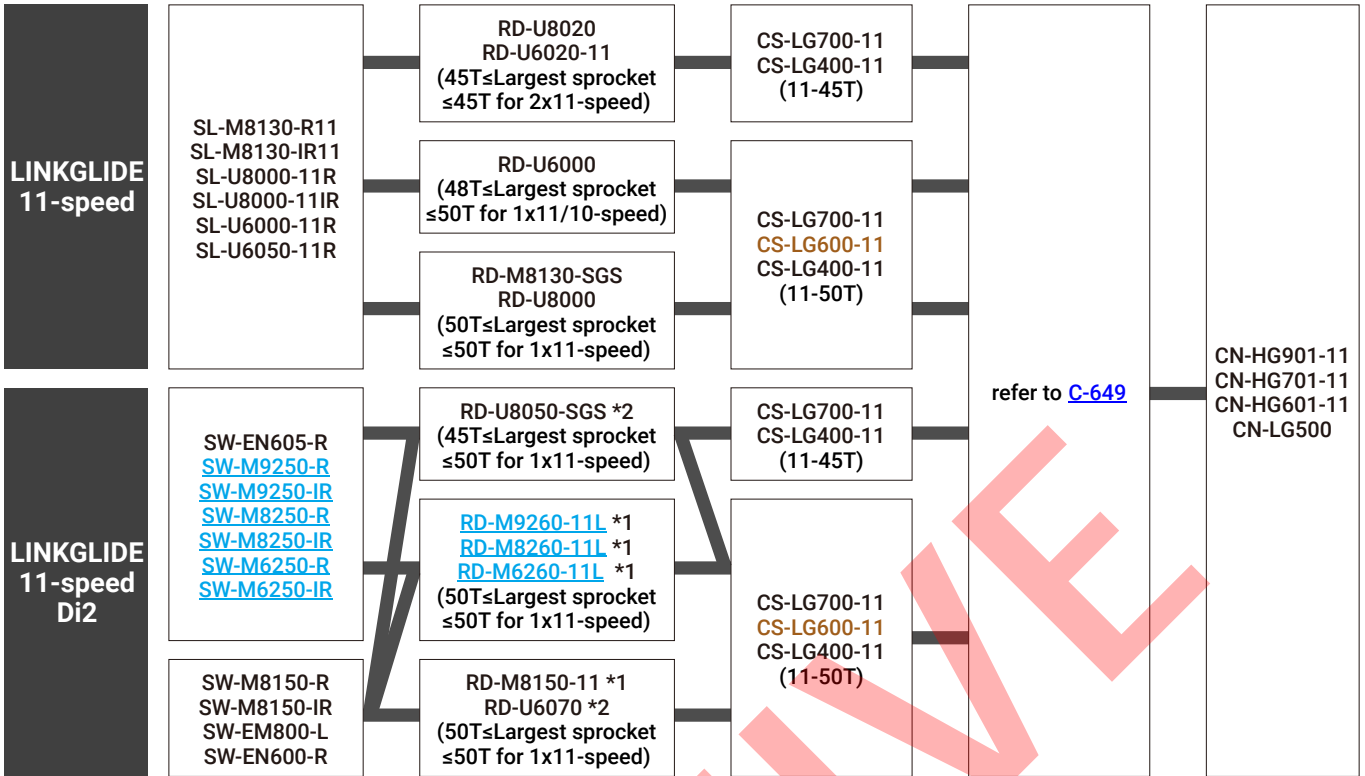
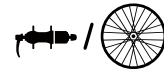

\*1 Only for E-BIKE

\*2 For E-BIKE or Q'AUTO ([FH-U6060](#)) bike

ARCHIVE

# 10-speed rear drivetrain [MTB, LIFESTYLE] C-436

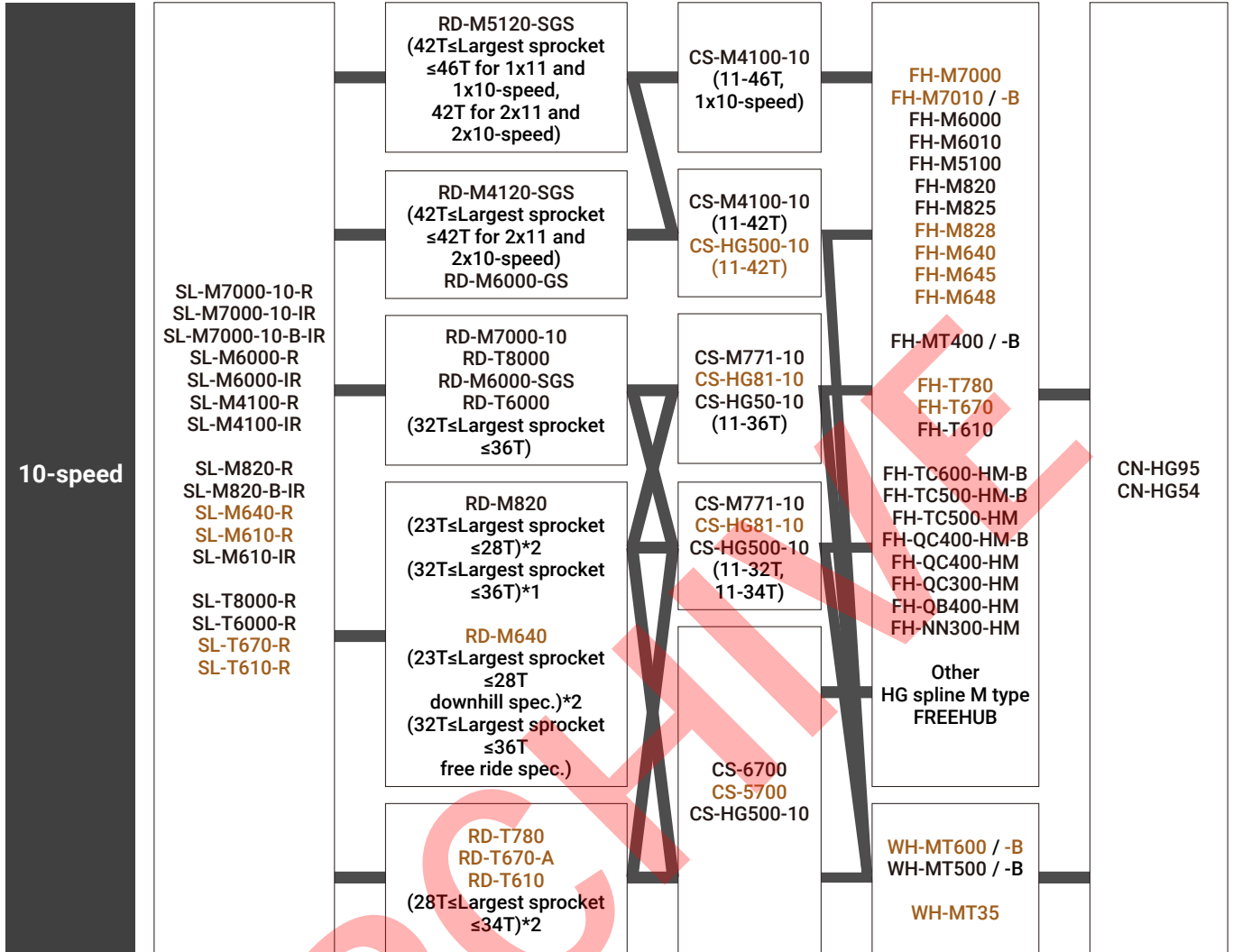
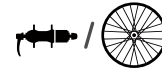

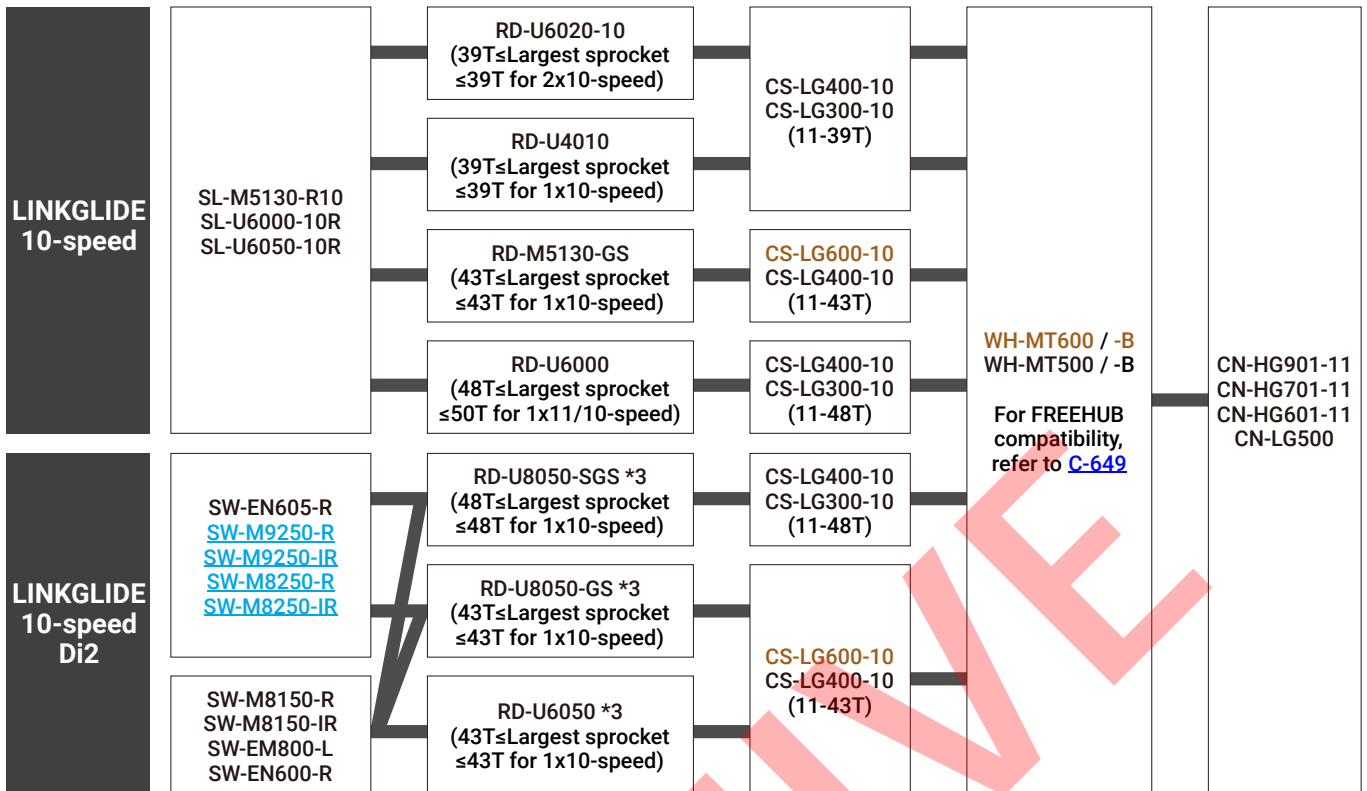
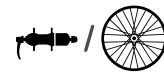

\*1 Mode converter

\*2 Compatible with ROAD cassette

\*3 For E-BIKE or Q/AUTO ([FH-U6060](#)) bike

ARCHIVE

# 9-speed rear drivetrain [MTB, LIFESTYLE] C-437

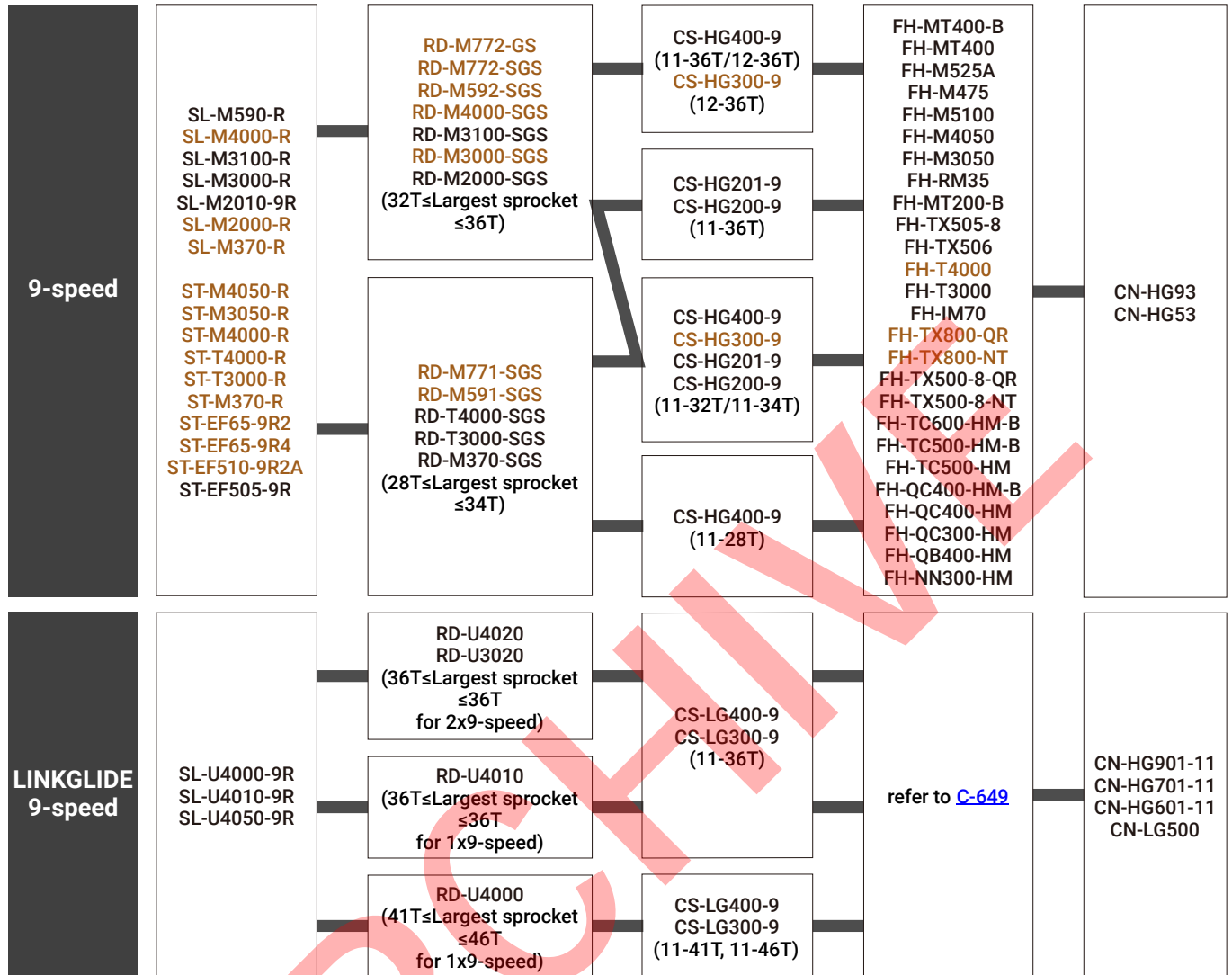

## 8-speed rear drivetrain [MTB] C-438

The rear derailleur for 8-speed can also be used for 7-speed drivetrain.

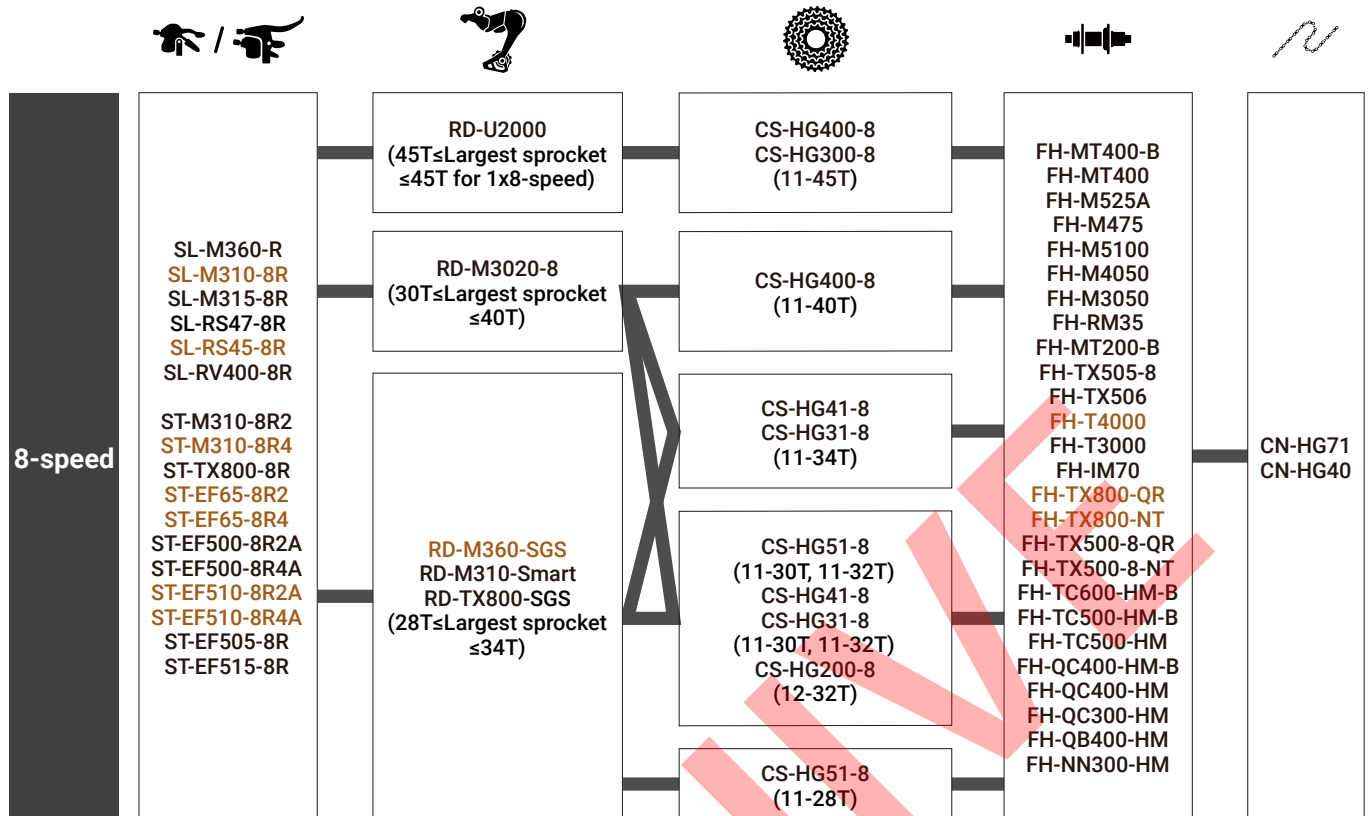

## 7-speed rear drivetrain [MTB] C-439

Cassette - HG spline M FREEHUB spec.

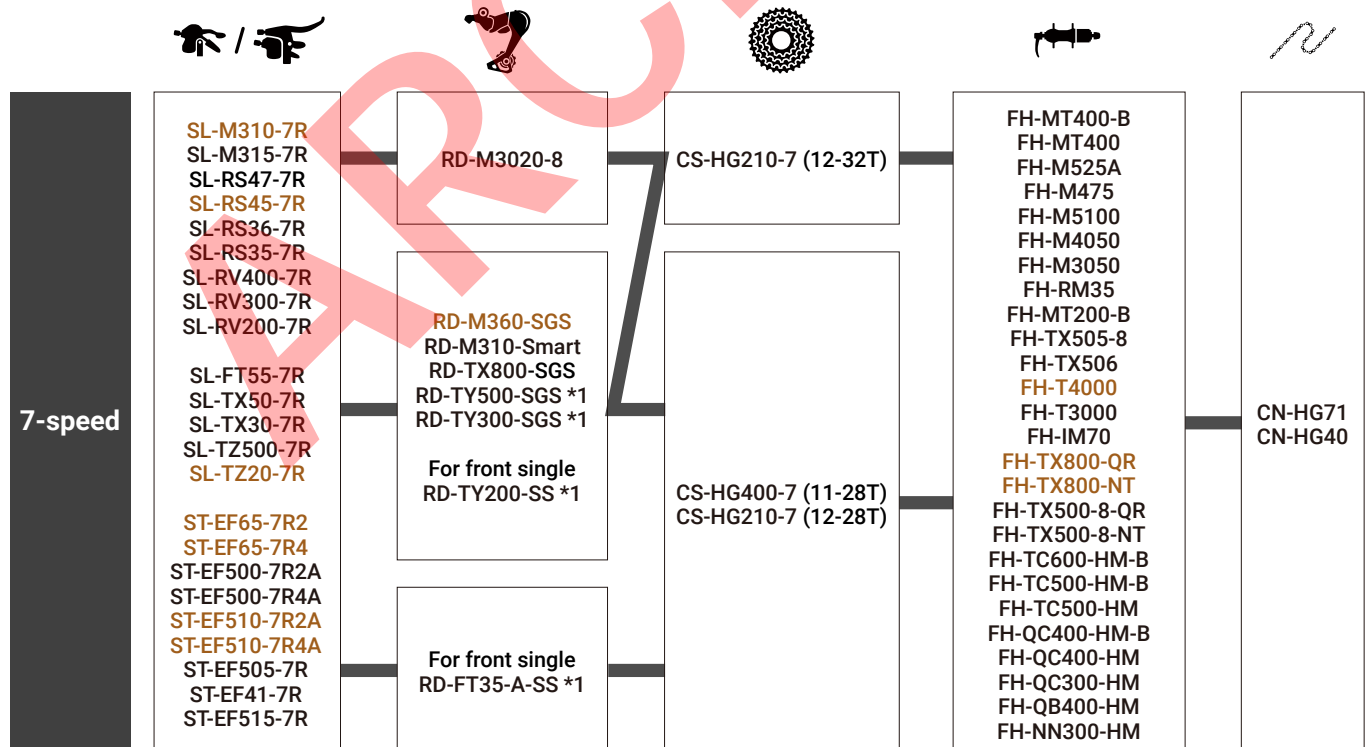

\*1 Direct attachment type only

Cassette - HG spline S FREEHUB spec.

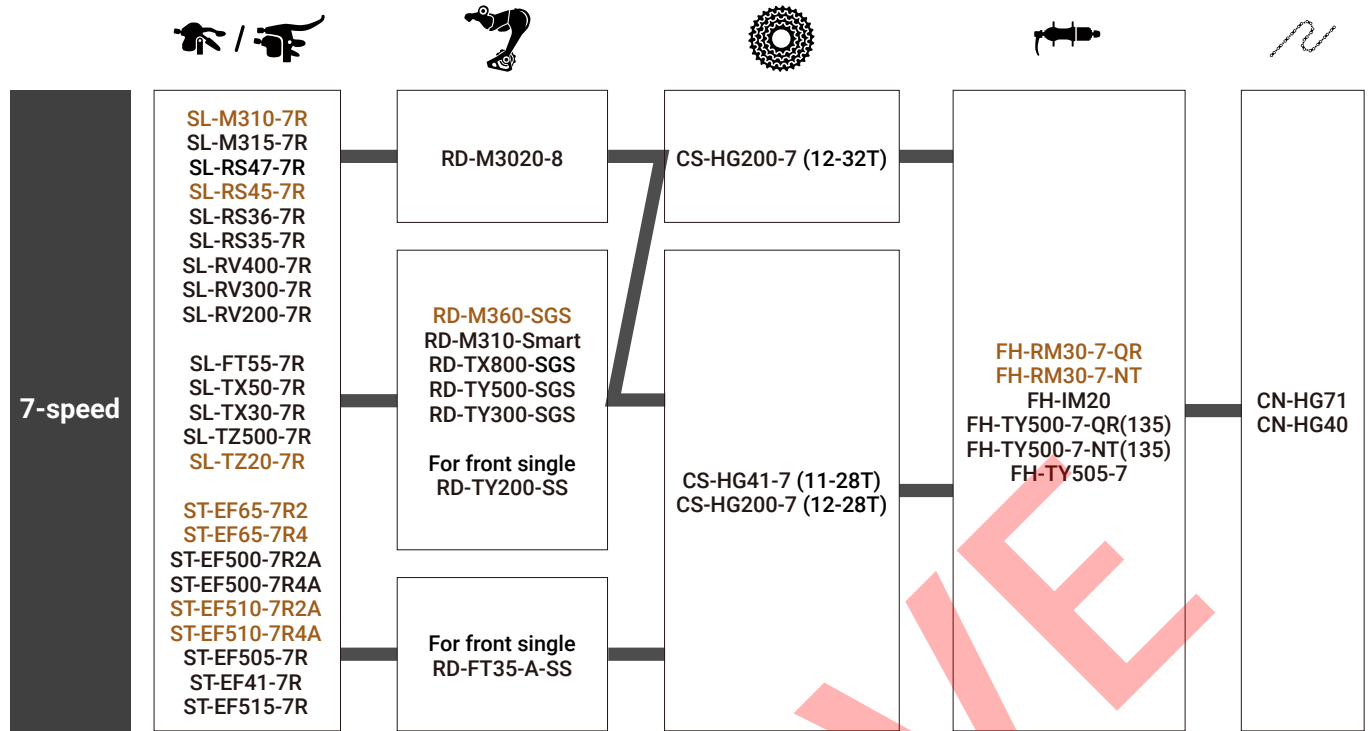

Multiple freewheel - Rear hub spec.

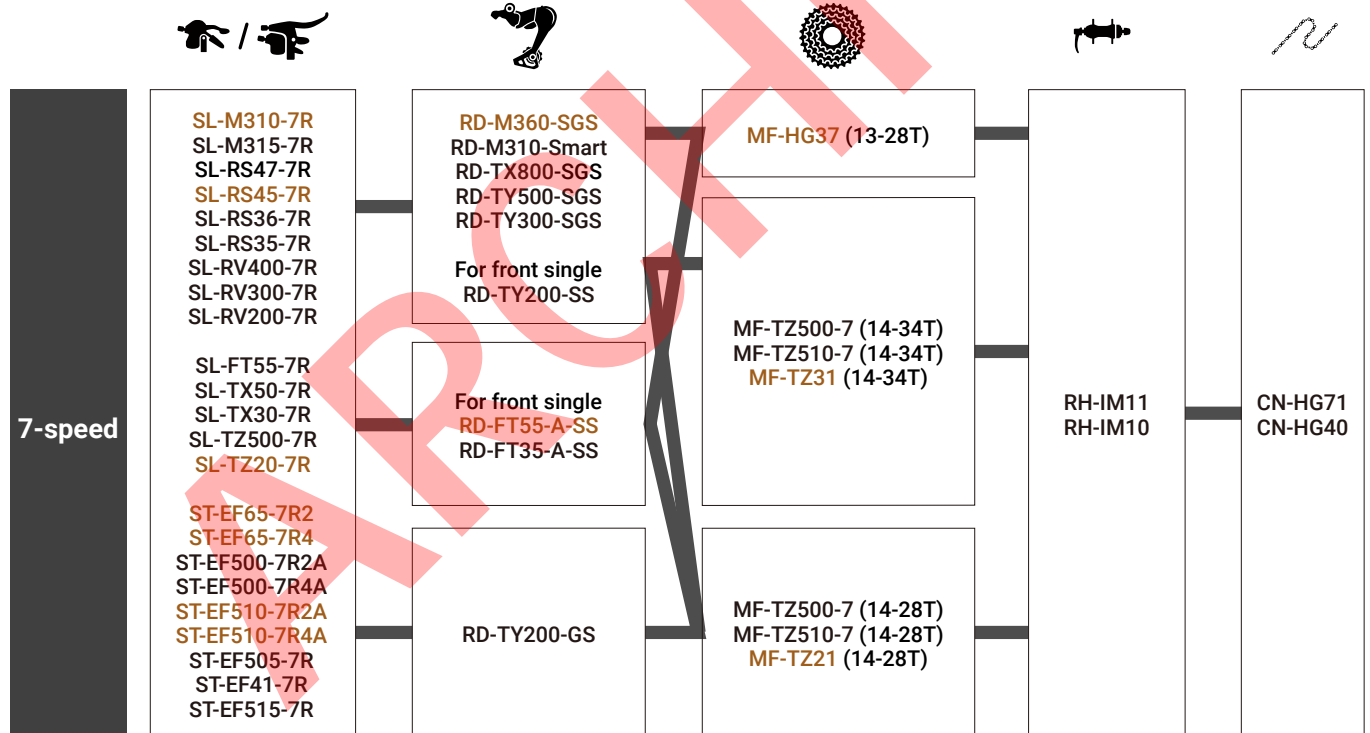

## 6-speed rear drivetrain [MTB] C-546

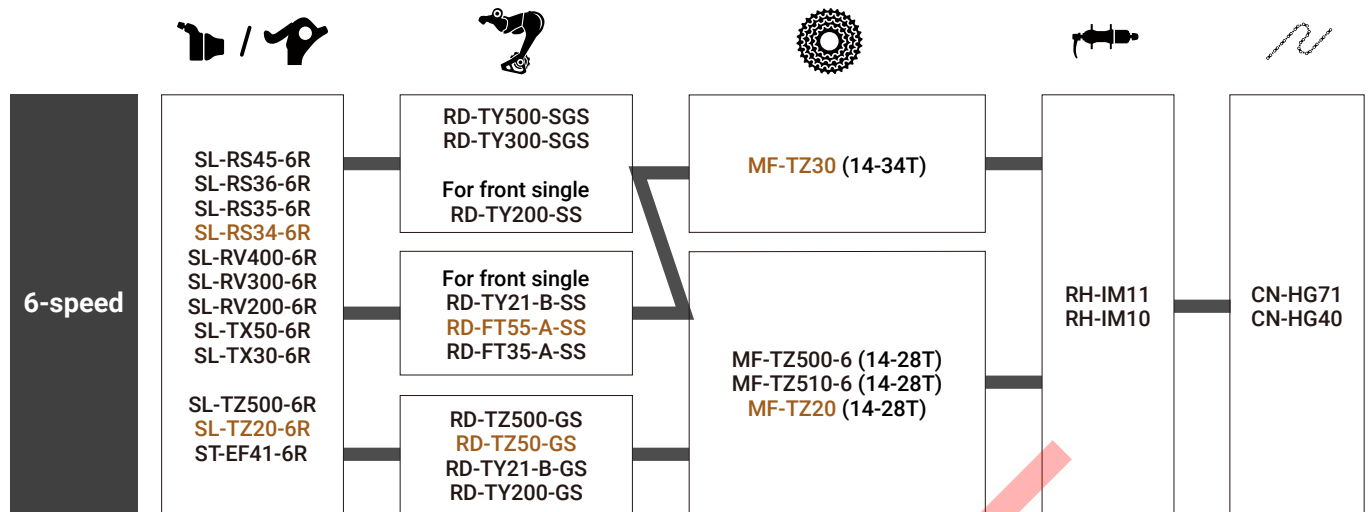

## Front drivetrain compatibility [MTB, Trekking, LIFESTYLE] C-440

### 12-speed front drivetrain [MTB] C-559

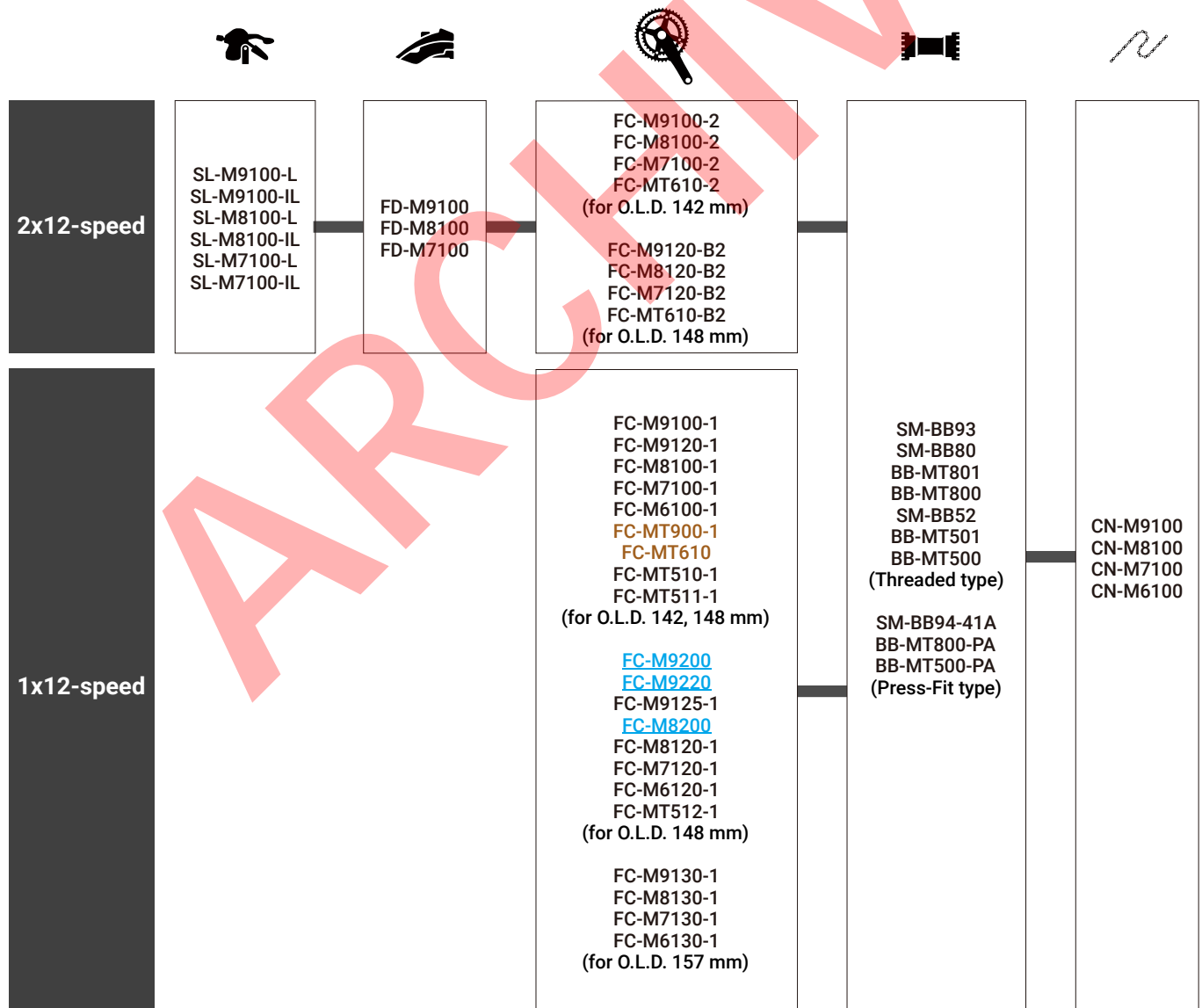

# 11-speed front drivetrain [MTB, LIFESTYLE] C-441

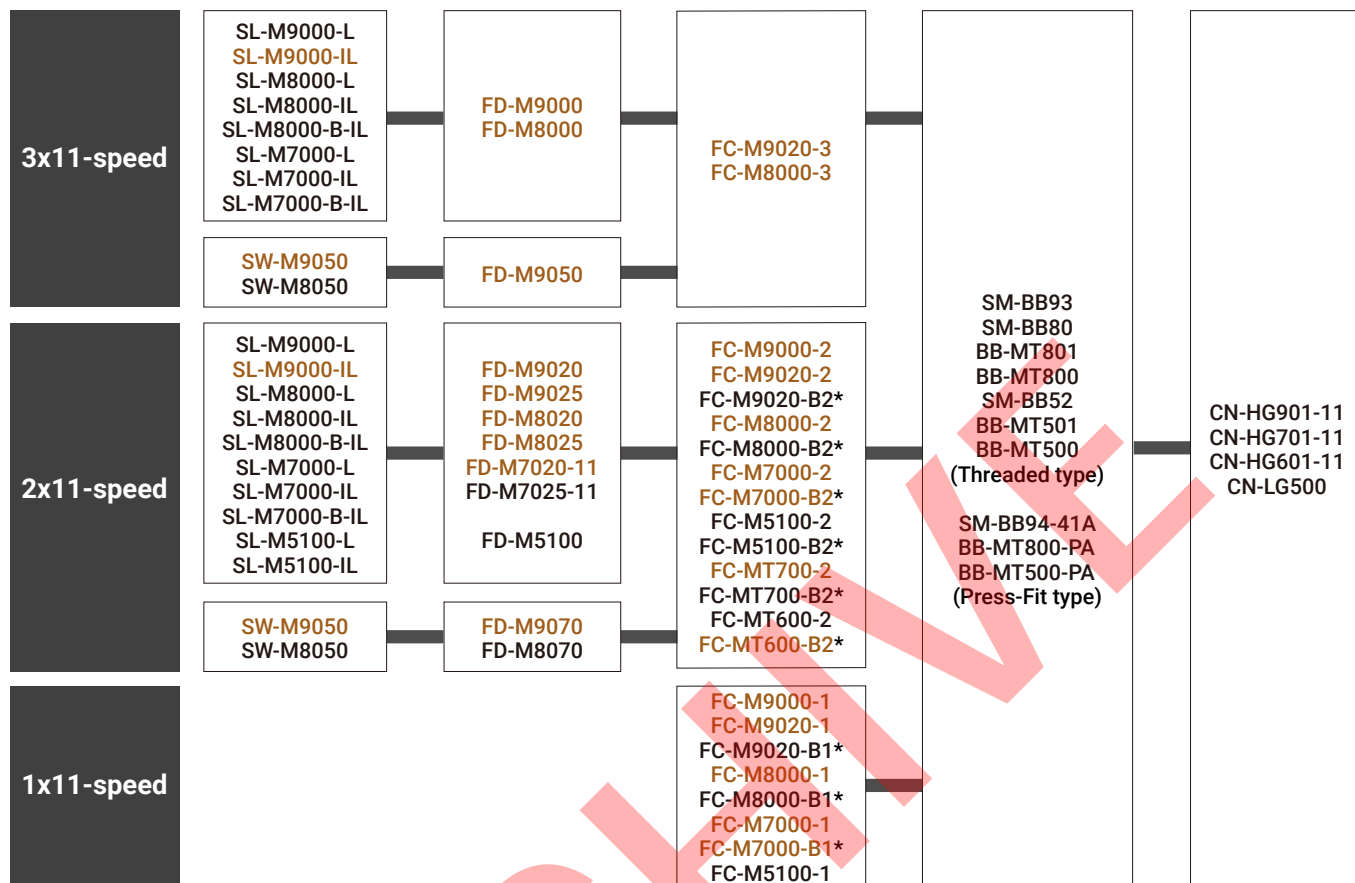

ARCH



**LINKGLIDE  
2x11-speed**

SL-U8000-L  
SL-U8000-IL  
SL-U6000-L  
SL-U4000-L

FD-U8010-L  
(For 46-32T  
at 11-speed)  
FD-U6010-L  
(For 40-26T/46-32T  
at 11-speed)

FC-U8000-2  
FC-U6010-2

SM-BB93  
SM-BB80  
BB-MT800  
SM-BB52  
BB-MT500  
(Threaded type)

FD-U6010-L  
(For 40-26T/46-32T  
at 11-speed)  
FD-U6000-D  
FD-U6000-E  
FD-U6000-M  
(For 36-22T/40-26T)

FC-U6000-2  
FC-U6000-2B  
FC-U4010-2B  
(36-22T)  
FC-U4010-2  
(36-22T/40-26T)

BB-MT801  
BB-MT501  
BB-UR400  
(Threaded type)

SM-BB94-41A  
BB-MT800-PA  
BB-MT500-PA  
(Press-Fit type)

FC-U4000-2  
(36-22T/40-26T)  
FC-U4000-2B  
(36-22T)

BB-UN55  
BB-UN26  
BB-UN101  
BB-UN300  
(Square type)

CN-HG901-11  
CN-HG701-11  
CN-HG601-11  
CN-LG500

**LINKGLIDE  
1x11-speed**

FC-U8000-1

SM-BB93  
SM-BB80  
BB-MT800  
SM-BB52  
BB-MT500  
(Threaded type)

FC-U6000-1

BB-MT801  
BB-MT501  
BB-UR400  
(Threaded type)

SM-BB94-41A  
BB-MT800-PA  
BB-MT500-PA  
(Press-Fit type)

FC-U4000-1  
FC-UT400-1

BB-UN55  
BB-UN26  
BB-UN101  
BB-UN300  
(Square type)

ARCHIVED

# 10-speed front drivetrain [MTB, Trekking, LIFESTYLE] C-442

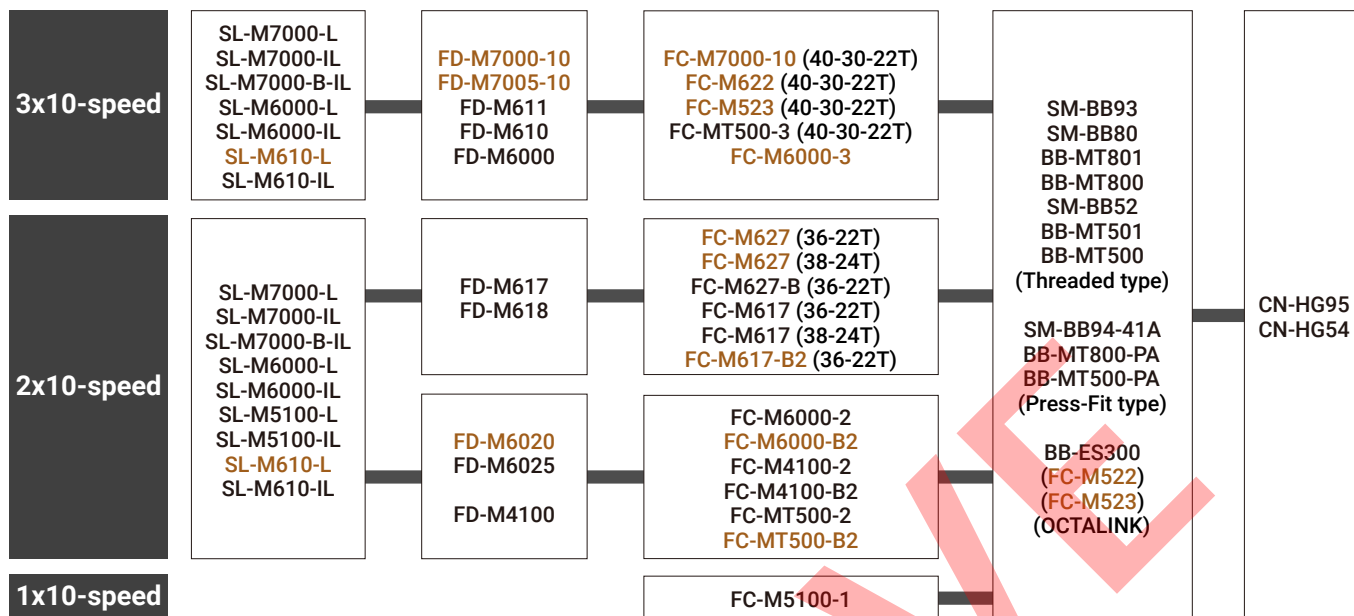

ARCHIVE



**3x10-speed  
Trekking**

SL-T8000-L  
SL-M780-L  
SL-M780-B-IL  
SL-T670-L  
SL-M670-L  
SL-M670-B-IL  
SL-T610-L  
SL-M610-L  
SL-M610-IL  
SL-M591-L  
SL-T6000-L

FD-T8000-3  
FD-T8000-6  
FD-T670-3  
FD-T670-6  
FD-T671-3  
FD-T610-3  
FD-T610-6  
FD-T611-3  
FD-T6000-3  
FD-T6000-6

FC-T8000 (48-36-26T)  
FC-T780 (48-36-26T)  
FC-T781 (44-32-24T)  
FC-T781 (48-36-26T)  
FC-M610 (48-36-26T)  
FC-T611 (44-32-24T)  
FC-T611 (48-36-26T)  
FC-T6010 (44-32-24T)  
FC-T6010 (48-36-26T)  
FC-T551 (44-32-24T)  
FC-T551 (48-36-26T)  
FC-T521 (44-32-24T)  
FC-T521 (48-36-26T)

SM-BB93  
BB-MT801  
BB-MT800  
SM-BB52  
BB-MT501  
BB-MT500  
(Threaded type)  
  
SM-BB94-41A  
BB-MT800-PA  
BB-MT500-PA  
(Press-Fit type)  
  
BB-ES300  
(FC-T521)  
(OCTALINK)

CN-M981  
CN-M980  
CN-HG95  
CN-HG94  
CN-HG75  
CN-HG74  
CN-HG54

**LINKGLIDE  
2x10-speed**

SL-U8000-L  
SL-U8000-IL  
SL-U6000-L  
SL-U4000-L

FD-U8010-L  
(For 46-30T  
at 10-speed)  
FD-U6010-L  
(For 46-30T  
at 10-speed)

FD-U6000-D  
FD-U6000-E  
FD-U6000-M  
FD-U4000-L  
FD-U4000-D  
FD-U4000-E  
FD-U4000-M  
(For 36-22T/40-26T)

FC-U6000-2  
FC-U4010-2  
(46-30T)

FC-U6000-2  
FC-U6000-2B  
FC-U4010-2B  
(36-22T)  
  
FC-U4010-2  
(36-22T/40-26T)

FC-U4000-2  
(36-22T/40-26T)  
FC-U4000-2B  
(36-22T)

BB-MT801  
BB-MT501  
BB-UR400  
(Threaded type)  
  
SM-BB94-41A  
BB-MT800-PA  
BB-MT500-PA  
(Press-Fit type)

BB-UN55  
BB-UN26  
BB-UN101  
BB-UN300  
(Square type)

CN-HG901-11  
CN-HG701-11  
CN-HG601-11  
CN-LG500

**LINKGLIDE  
1x10-speed**

FC-U8000-1

FC-U6000-1

FC-U4000-1  
FC-UT400-1

SM-BB93  
SM-BB80  
BB-MT800  
SM-BB52  
BB-MT500  
(Threaded type)

BB-MT801  
BB-MT501  
BB-UR400  
(Threaded type)  
  
SM-BB94-41A  
BB-MT800-PA  
BB-MT500-PA  
(Press-Fit type)

BB-UN55  
BB-UN26  
BB-UN101  
BB-UN300  
(Square type)

CN-HG901-11  
CN-HG701-11  
CN-HG601-11  
CN-LG500



# 9-speed front drivetrain [MTB, LIFESTYLE] C-445

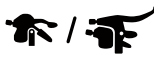

3x9-speed

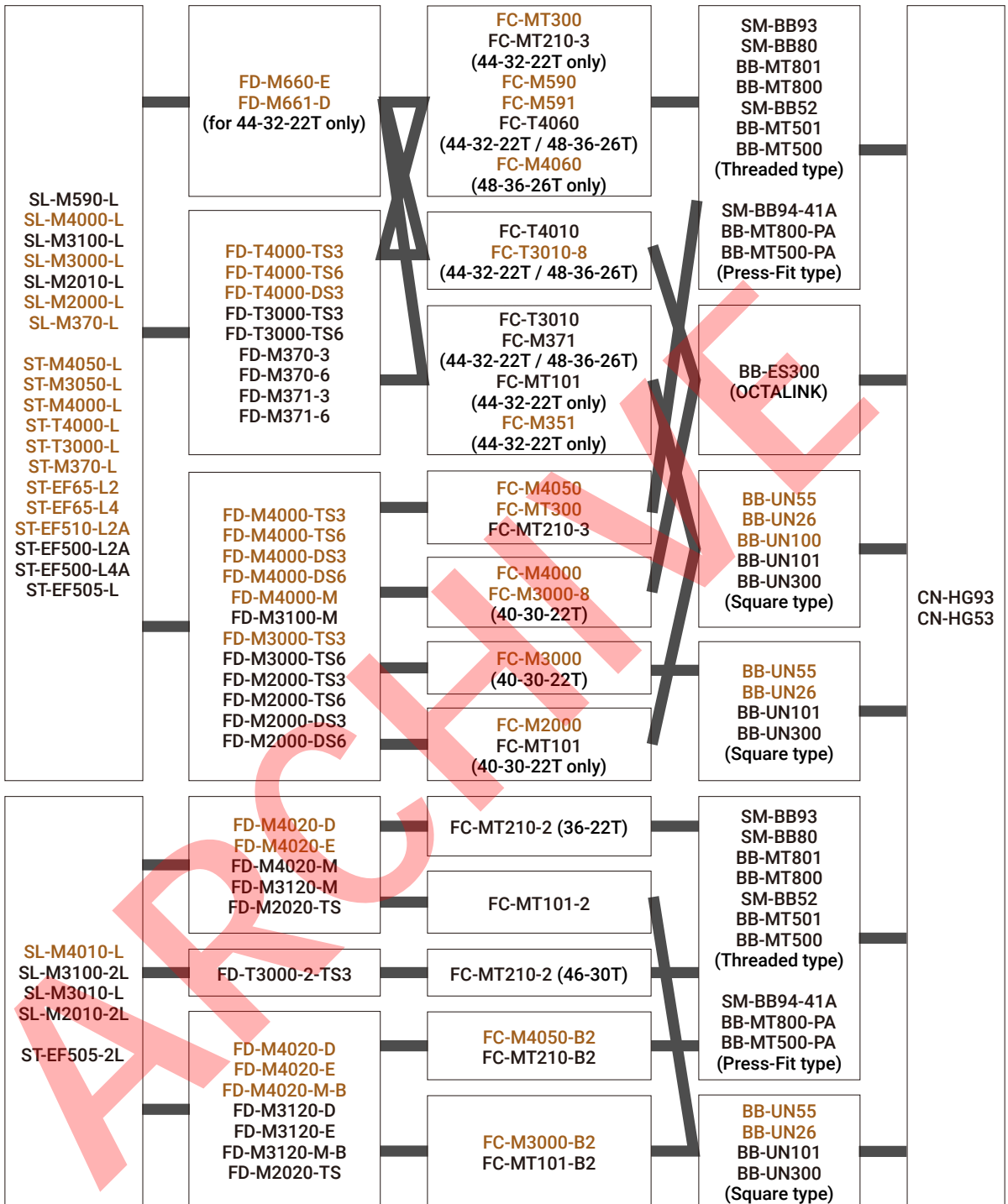

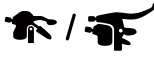

**LINKGLIDE  
2x9-speed**

SL-U8000-L  
SL-U8000-IL  
SL-U6000-L  
SL-U4000-L

FD-U4010-L  
(For 46-30T)

FD-U4000-L  
FD-U4000-D  
FD-U4000-E  
FD-U4000-M  
(For 36-22T/40-26T)

FC-U6000-2  
FC-U4010-2  
(46-30T)

FC-U6000-2  
FC-U6000-2B  
FC-U4010-2B  
(36-22T)  
  
FC-U4010-2  
(36-22T/40-26T)

FC-U4000-2  
(36-22T/40-26T)  
FC-U4000-2B  
(36-22T)

BB-MT801  
BB-MT501  
BB-UR400  
(Threaded type)

SM-BB94-41A  
BB-MT800-PA  
BB-MT500-PA  
(Press-Fit type)

BB-UN55  
BB-UN26  
BB-UN101  
BB-UN300  
(Square type)

**LINKGLIDE  
1x9-speed**

FC-U8000-1

FC-U6000-1

FC-U4000-1  
FC-UT400-1

SM-BB93  
SM-BB80  
BB-MT800  
SM-BB52  
BB-MT500  
(Threaded type)

BB-MT801  
BB-MT501  
BB-UR400  
(Threaded type)

SM-BB94-41A  
BB-MT800-PA  
BB-MT500-PA  
(Press-Fit type)

BB-UN55  
BB-UN26  
BB-UN101  
BB-UN300  
(Square type)

CN-HG901-11  
CN-HG701-11  
CN-HG601-11  
CN-LG500

ARCHIVE

# 8,7,6-speed front drivetrain [MTB, LIFESTYLE] C-446

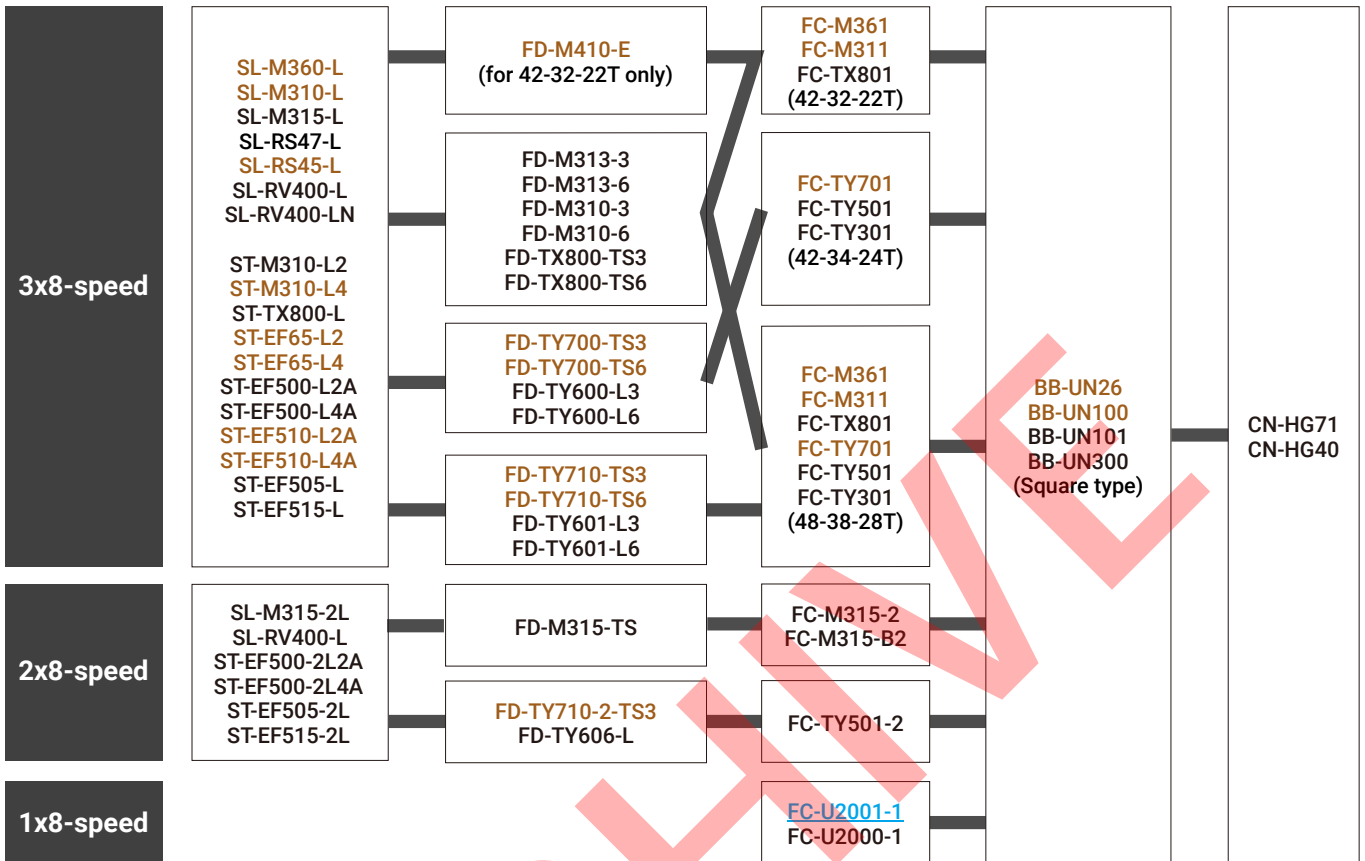
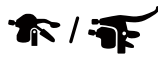

ARCHIVED

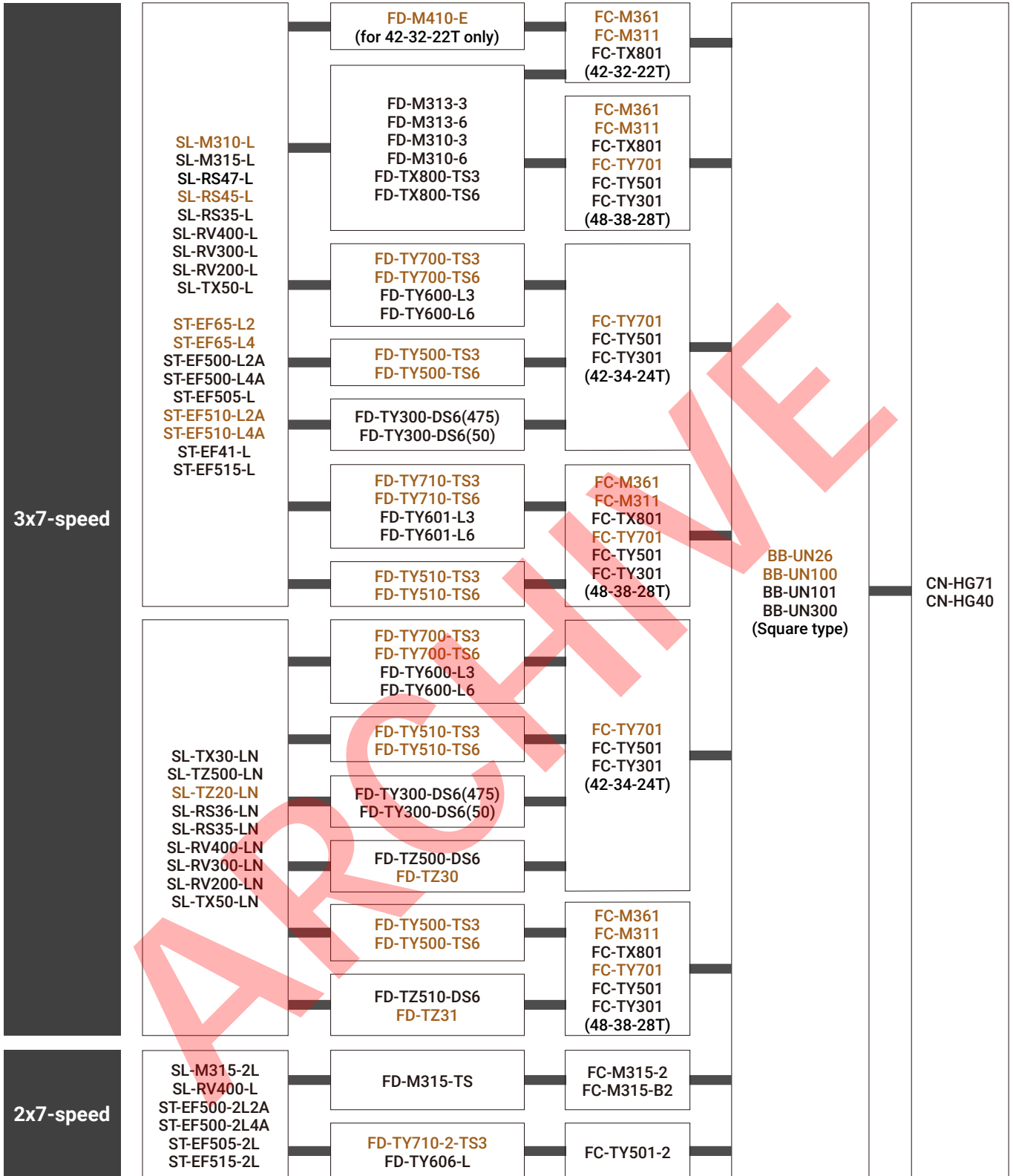
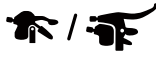

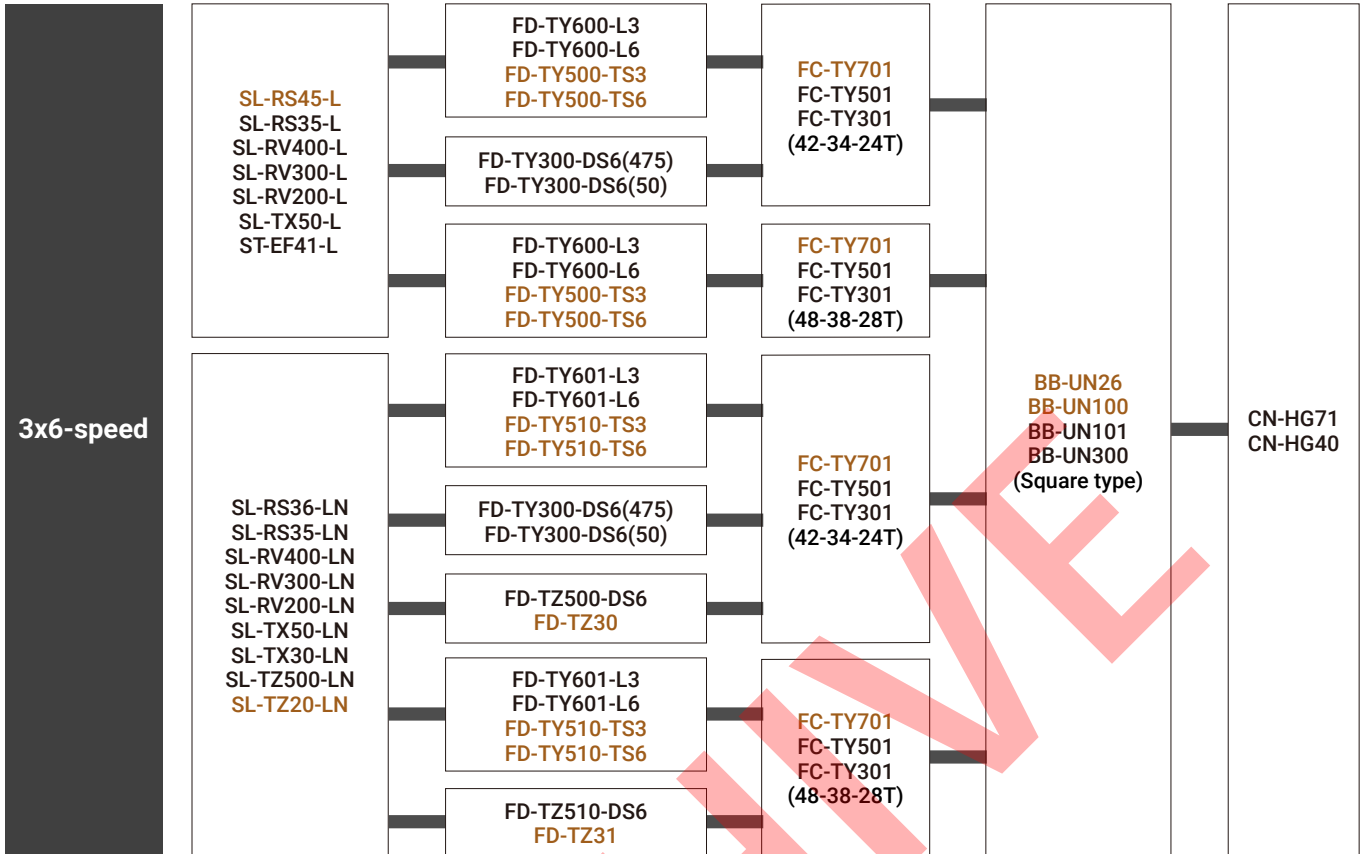
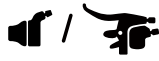

## Front derailleur and crankset

C-447

The allowable combinations of front derailleurs depend on the difference in the number of teeth of the gears and the shape of the front derailleur plate.

If the conditions given below are not satisfied, then the desired shiftability may not be obtained.

$$FC \text{ (largest chainring) - (smallest chainring)} \leq FD \text{ (high and low capacity)}$$

$$FC \text{ (largest chainring) - (middle chainring)} = FD \text{ (allowance of difference in teeth number between top and middle)}$$

Each front derailleurs and the number of teeth of corresponding cranksets are given in the compatibility chart.

## Front derailleur and chain line (TOURNEY)

C-448

The SHIMANO line-up for front derailleurs and the chain lines they support are given in the chart below.

Chain line (mm)		28.6 mm (S)	31.8 mm (M)	34.9 mm (L)
		FD-TY300-DS6(475)		47.5
	FD-TY300-DS6(50)		-	50.0
	FD-TZ510-DS6 FD-TZ500-DS6 FD-TZ31 FD-TZ30		47.5	-
	FD-TY600-L3 FD-TY600-L6	-	47.5 50	47.5 50
	FD-TY601-L3 FD-TY601-L6	-	47.5 50	47.5 50

# Crankset, bottom bracket and chain line [MTB, LIFESTYLE]

C-449

In order to use SIS (SHIMANO INDEX SYSTEM) to its full extent, the required correct chain line, along with the crankset and bottom bracket required to obtain that, are given in the chart below.

## Separate type FC-BB compatibility [MTB, LIFESTYLE] C-450

### 11, 10, 9-speed

Speed	Series	Crankset				Bottom bracket	Chain line and axle mark								
		Model No.	Type of crank				Model No.	47.5 mm	50.0 mm	52.5 mm	47.5+t mm	48.8 mm	51.8 mm	52 mm	56 mm
			OCTALINK	Square	Chain case										
11, 10, 9	CUES	FC-U4000-1 (40T/42T)	-	✓	✓*1	BB-UN300(-K) BB-UN101(-K)	-	LL123	-	-	-	-	-	-	
		FC-U4000-1 (30T/32T)	-	✓	-	BB-UN300 BB-UN101	-	-	-	-	-	-	LL123	-	
		FC-U4000-2	-	✓	-	BB-UN300 BB-UN101	-	-	-	-	LL123	-	-	-	
		FC-U4000-2B	-	✓	-	BB-UN300 BB-UN101	-	-	-	-	-	LL123	-	-	
	SHIMANO	FC-UT400-1	-	✓	-	BB-UN300 BB-UN101	-	-	-	-	-	LL123	LL123		
10	SHIMANO	FC-M523	✓	-	-	BB-ES300	-	118	-	-	-	-	-		
		FC-M522	✓	-	-	BB-ES300	-	113	-	-	-	-	-		
9	SHIMANO ALIVIO	FC-M4000	✓	-	-	BB-ES300	-	118	-	-	-	-	-		
		FC-T4010	✓	-	✓*1	BB-ES300(-K)	-	126	-	-	-	-	-		
		FC-M430-8	✓	-	-	BB-ES300(-E)	-	118	-	-	-	-	-		
		FC-M430	-	✓	-	BB-UN26(-E) BB-UN300(-E)	-	LL113	-	-	-	-	-		
		FC-M3000-8	✓	-	-	BB-ES300	-	118	-	-	-	-	-		
	ACERA	FC-M3000	-	✓	-	BB-UN26 BB-UN300	-	LL113	-	-	-	-	-		
		FC-M3000-B2	-	✓	-	BB-UN26 BB-UN300	-	LL113	-	-	-	-	-		
		FC-T3010-8	✓	-	✓*1	BB-ES300(-K)	-	126	-	-	-	-	-		
	FC-T3010	-	✓	✓*1	BB-UN26(-K) BB-UN300(-K)	-	LL123	-	-	-	-	-			
	ALTUS	FC-M2000	-	✓	-	BB-UN26 BB-UN300 BB-UN100 BB-UN101	-	LL123	-	-	-	-	-		
	SHIMANO	FC-MT100	-	✓	-	BB-UN26 BB-UN300 BB-UN100 BB-UN101	-	LL123	-	-	-	-	-		
FC-MT101		-	✓	-	BB-UN26 BB-UN300 BB-UN100 BB-UN101	-	LL123	-	-	-	-	-			
FC-M371		-	✓	✓*1	BB-UN26(-K) BB-UN300(-K)	-	LL123	-	-	-	-	-			
		FC-M351	-	✓	✓*1	BB-UN26(-K) BB-UN300(-K)	-	LL123	-	-	-	-			

\*1 Chain case stay thickness should be 1.5 mm to 2.1 mm.

#### NOTE

- If using a chain case, select a BB-xxxx (-K) / -K bottom bracket.
- If using an E-type front derailleur, select a BB-xxxx (-E) bottom bracket.
- **FC-M521:** Use 121AK with 1.8 mm spacer if no chain case used.

## 8, 7, 6-speed

Speed	Series	Model No.	Crankset			Bottom bracket	Chain line and axle mark							
			Type of crank				Model No.	47.5 mm	50.0 mm	52.5 mm	47.5+t mm	48.8 mm	51.8 mm	52 mm
			OCTALINK	Square	Chain case									
8, 7	ACERA ALTUS	FC-M361 FC-M311	–	✓	✓*1	BB-UN26(-K) BB-UN300(-K)	–	LL123	–	–	–	–	–	
	TOURNEY	FC-TX801	–	✓	✓*1	BB-UN26(-K) BB-UN300(-K) BB-UN100(-K) BB-UN101(-K)	–	LL123	–	–	–	–	–	
	SHIMANO	FC-M315-2	–	✓	–	BB-UN26 BB-UN300 BB-UN100 BB-UN101	–	–	–	–	LL123	–	–	
		FC-M315-B2	–	✓	–	BB-UN26 BB-UN300 BB-UN100 BB-UN101	–	–	–	–	–	LL123	–	
		FC-TY501-2	–	✓	–	BB-UN26 BB-UN300 BB-UN100 BB-UN101	–	–	–	–	LL123	–	–	
8, 7, 6	SHIMANO ESSA	FC-U2001-1 (40T) FC-U2000-1 (40T)	–	✓	✓*1	BB-UN300(-K) BB-UN101(-K)	–	LL123	–	–	–	–	–	
		FC-U2000-1 (32T)	–	✓	–	BB-UN300 BB-UN101	–	–	–	–	–	–	LL123	
	SHIMANO	FC-TY701 FC-TY501 FC-TY301	–	✓	✓	BB-UN26(-K) BB-UN300(-K) BB-UN100(-K) BB-UN101(-K)	D-NL (122.5)	D-EL	–	D-NL-K (122.5)	–	–	–	

\*1 Chain case stay thickness should be 1.5 mm to 2.1 mm.

### NOTE

- If using a chain case, select a BB-xxxx (-K) / -K bottom bracket.
- If using an E-type front derailleur, select a BB-xxxx (-E) bottom bracket.

# Drivetrain for ROAD, Gravel, LIFESTYLE components

C-453

## 9, 10, 11, 12-speed rear drivetrain compatibility

C-806

For more detail and 7/8-speed compatibility, please refer to [C-454](#).

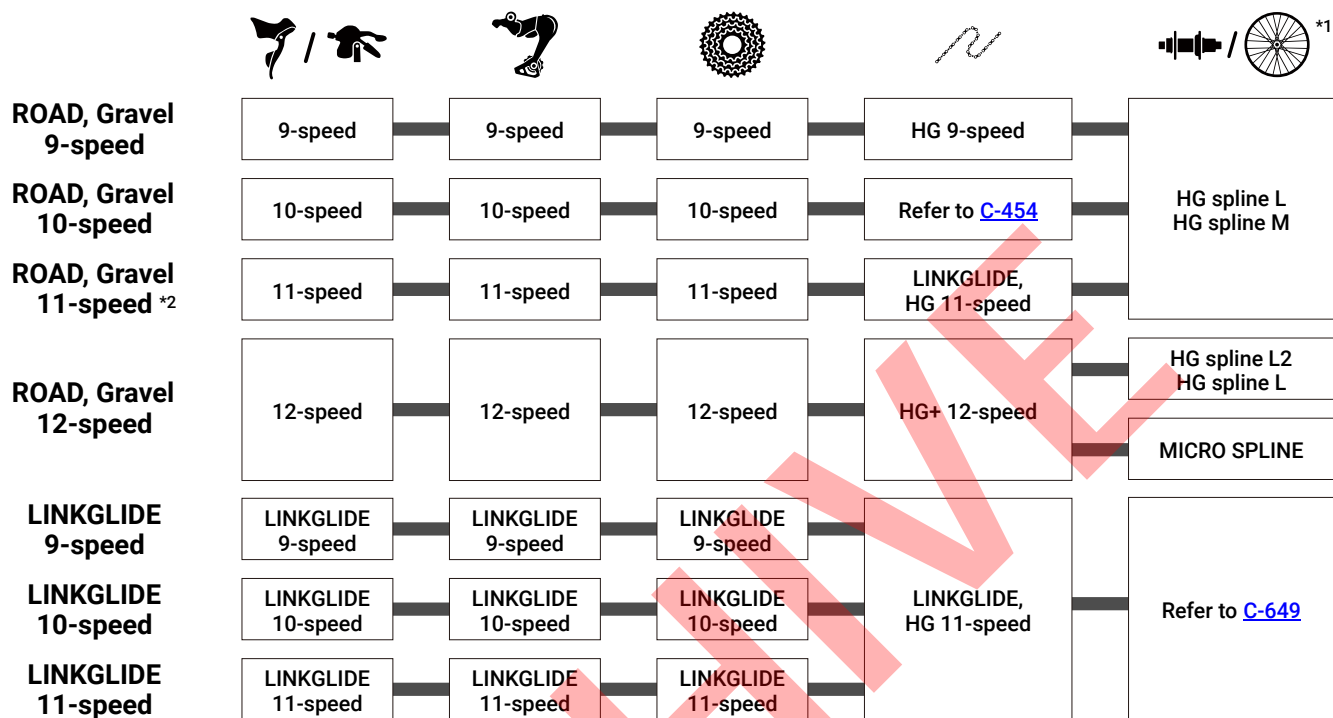

\*1 Please refer to [C-731](#) for the compatibility with wheel and freehub in detail.

\*2 TIAGRA R4000 series and [RD-U6040](#) are exceptions. Please refer to [C-454](#).

# Rear drivetrain compatibility

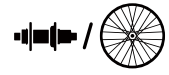

**2x12-speed**  
**SHIMANO 105**  
**R7100**

**GRX**  
**RX820**  
**RX610**

ST-R7120  
ST-RX820  
ST-RX610

RD-R7100  
(34T≤Largest sprockets36T)  
RD-RX820  
(34T≤Largest sprockets36T)

CS-R8101-12  
CS-R7101-12  
CS-HG710-12

CN-M9100  
CN-M8100  
CN-M7100  
CN-M6100

WH-R9200  
(O.L.D. 130 mm, HG spline L)  
WH-R9270  
WH-RX880  
(O.L.D. 142 mm, HG spline L)  
WH-R9170  
WH-R8170  
WH-RS770  
WH-RS710  
WH-RS370  
WH-RS171 (700c)  
WH-RS171 (650b)  
WH-RX870  
WH-RX570  
WH-RX180  
WH-RX31 (E-THRU)  
FH-RS770  
FH-R7070  
FH-RS470  
FH-TC500-HL  
(O.L.D. 142 mm, HG spline L)

**2x12-speed**  
**DURA-ACE**  
**R9250**

**ULTEGRA**  
**R8150**

**SHIMANO 105**  
**R7150**

**GRX**  
**RX825**

ST-R9250  
ST-R9270  
ST-R9160  
ST-R9180  
ST-R8150  
ST-R8170  
ST-R8060  
ST-R7170  
ST-RX825

RD-R9250  
RD-R8150  
(30T≤Largest sprockets34T)  
RD-R7150  
(34T≤Largest sprockets36T)  
RD-RX825  
(34T≤Largest sprockets36T)

CS-R9200-12  
CS-R8100-12  
CS-R7100-12  
CS-R8101-12  
CS-R7101-12  
CS-HG710-12

CN-M9100  
CN-M8100  
CN-M7100  
CN-M6100

WH-R9100  
WH-RS700  
WH-RS500  
WH-RS300  
WH-RS100  
FH-9000  
FH-6800  
FH-5800  
FH-R7000  
FH-RS400  
(O.L.D. 130 mm, HG spline L)  
WH-RX830  
WH-RX31 (QR)  
WH-RX010  
WH-U5000  
FH-CX75  
FH-RS505  
(O.L.D. 135 mm, HG spline L)

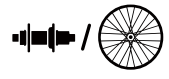

1x12-speed

GRX  
RX825  
RX820  
RX610

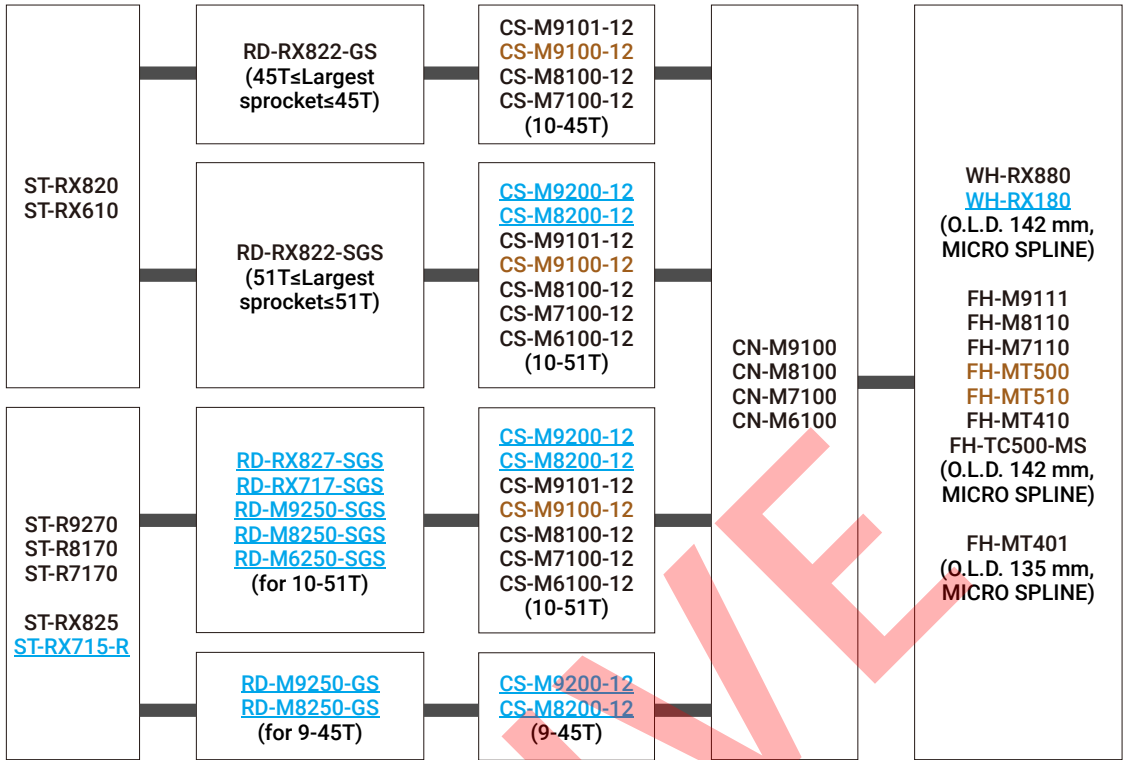

ARCHIVE

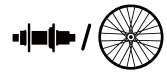

**2x11-speed**

**DURA-ACE  
R9100  
9000**

**ULTEGRA  
R8000  
6800**

**SHIMANO 105  
R7000  
5800**

**TIAGRA  
R4000**

**GRX  
RX810  
RX600**

**CUES  
U6000**

**METREA  
U5000**

ST-R9100  
ST-R9120  
ST-9001  
**ST-9000**  
SL-BSR1  
ST-R8000  
ST-R8020  
ST-R8025  
ST-6800  
ST-R7000  
ST-R7020  
ST-R7025  
ST-5800  
  
SL-RS700  
ST-RS685  
**ST-RS505**  
  
**ST-U5060**  
SL-U5000  
ST-RX810  
ST-RX600

RD-R9100-SS  
RD-R8000-SS  
(25T≤Largest  
sprockets≤30T)

RD-R8000-GS  
RD-RX800-GS  
(28T≤Largest  
sprockets≤34T)

RD-9000  
RD-6800-SS  
**RD-5800-SS**  
(23T≤Largest  
sprockets≤28T)

RD-R7000-SS  
(25T≤Largest  
sprockets≤30T)

RD-R7000-GS  
(28T≤Largest  
sprockets≤34T)

RD-6800-GS  
**RD-5800-GS**  
(28T≤Largest  
sprockets≤32T)

**RD-U5000-SS**  
(28T≤Largest  
sprockets≤32T)

RD-RX810  
(30T≤Largest  
sprockets≤34T)

RD-RX800  
(28T≤Largest  
sprockets≤34T)

ST-R9150  
ST-R9160  
ST-R9170  
ST-R9180  
**ST-9070**  
ST-R8050  
ST-R8060  
ST-R8070  
**ST-9071**  
  
ST-6870  
ST-6871  
ST-RX815  
**ST-R785**

RD-R9150-SS  
RD-R8050-SS  
(25T≤Largest  
sprockets≤30T)

**RD-9070-SS**  
RD-6870-SS  
(23T≤Largest  
sprockets≤28T)

RD-R8050-GS  
RD-RX805  
(28T≤Largest  
sprockets≤34T)

RD-6870-GS  
(28T≤Largest  
sprockets≤32T)

RD-RX815  
(30T≤Largest  
sprockets≤34T)

**ST-R4020**  
ST-U6030

**RD-R4000**  
**RD-U6040**  
(36T≤Largest  
sprockets≤36T)

CS-R9100

**CS-9000**  
**CS-6800**  
**CS-5800**  
CS-R8000  
CS-HG800-11  
CS-R7000  
CS-HG700-11

**CS-RS400-11**

CN-HG901-11  
CN-HG701-11  
CN-HG601-11

CN-LG500

FH-9000  
WH-R9100  
WH-RS700  
WH-RS500  
WH-RS300  
WH-RS100  
FH-6800  
**FH-5800**  
FH-R7000  
FH-RS400  
(O.L.D. 130 mm)

**FH-CX75**  
FH-RS505  
WH-RX830  
**WH-RX31 (QR)**  
WH-U5000  
WH-RX010  
(O.L.D. 135 mm)

WH-R9170  
WH-R8170  
WH-RS710  
**WH-RS770**  
WH-RS370  
WH-RS171 (700c)  
**WH-RS171 (650b)**  
WH-RX870  
WH-RX570  
**WH-RX180**  
**WH-RX31 (E-THRU)**  
FH-RS770  
FH-R7070  
FH-RS470  
FH-TC500-HL  
(O.L.D. 142 mm)

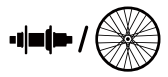

**1x11-speed**

**METREA  
U5000**

ST-U5060  
SL-U5000

RD-U5000-SS

CS-R9100  
CS-9000  
CS-6800  
CS-5800  
CS-R8000  
CS-HG800-11  
CS-R7000  
CS-HG700-11

FH-9000  
WH-R9100  
WH-RS700  
WH-RS500  
WH-RS300  
WH-RS100  
FH-6800  
FH-5800  
FH-R7000  
FH-RS400  
(O.L.D. 130 mm)

**GRX  
RX810  
RX600**

ST-R9100  
ST-R9120  
ST-9001  
ST-9000  
SL-BSR1  
ST-R8000  
ST-R8020  
ST-R8025  
ST-6800  
ST-R7000  
ST-R7020  
ST-R7025  
ST-5800

RD-RX812  
(40T≤Largest  
sprockets≤42T)

CS-M8000-11  
CS-M7000-11  
CS-M5100-11

CN-HG901-11  
CN-HG701-11  
CN-HG601-11

FH-CX75  
FH-RS505  
WH-RX830  
WH-RX31 (QR)  
WH-U5000  
WH-RX010  
(O.L.D. 135 mm)

SL-RS700  
ST-RS685  
ST-RS505

ST-U5060  
SL-U5000  
ST-RX810  
ST-RX600

CN-LG500

WH-R9170  
WH-R8170  
WH-RS710  
WH-RS770  
WH-RS370  
WH-RS171 (700c)  
WH-RS171 (650b)  
WH-RX870  
WH-RX570  
WH-RX180  
WH-RX31 (E-THRU)  
FH-RS770  
FH-R7070  
FH-RS470  
FH-TC500-HL  
(O.L.D. 142 mm)

ST-R9150  
ST-R9160  
ST-R9170  
ST-R9180  
ST-9070  
ST-R8050  
ST-R8060  
ST-R8070  
ST-9071

RD-RX817  
(40T≤Largest  
sprockets≤42T)

ST-6870  
ST-6871  
ST-RX815  
ST-R785

**1x11-speed  
LINKGLIDE**

**CUES  
U6000**

ST-U6030

RD-M8130  
RD-U8000  
(50T≤Largest  
sprockets≤50T  
for 1x11-speed)  
RD-U6000  
(48T≤Largest  
sprockets≤50T)

CS-LG700-11  
CS-LG600-11

CS-LG400-11  
(11-50T)

refer to [C-649](#)



**2x10-speed**

**ULTEGRA  
6700**

**SHIMANO 105  
5700**

**TIAGRA  
4700  
4600**

**GRX  
RX400**

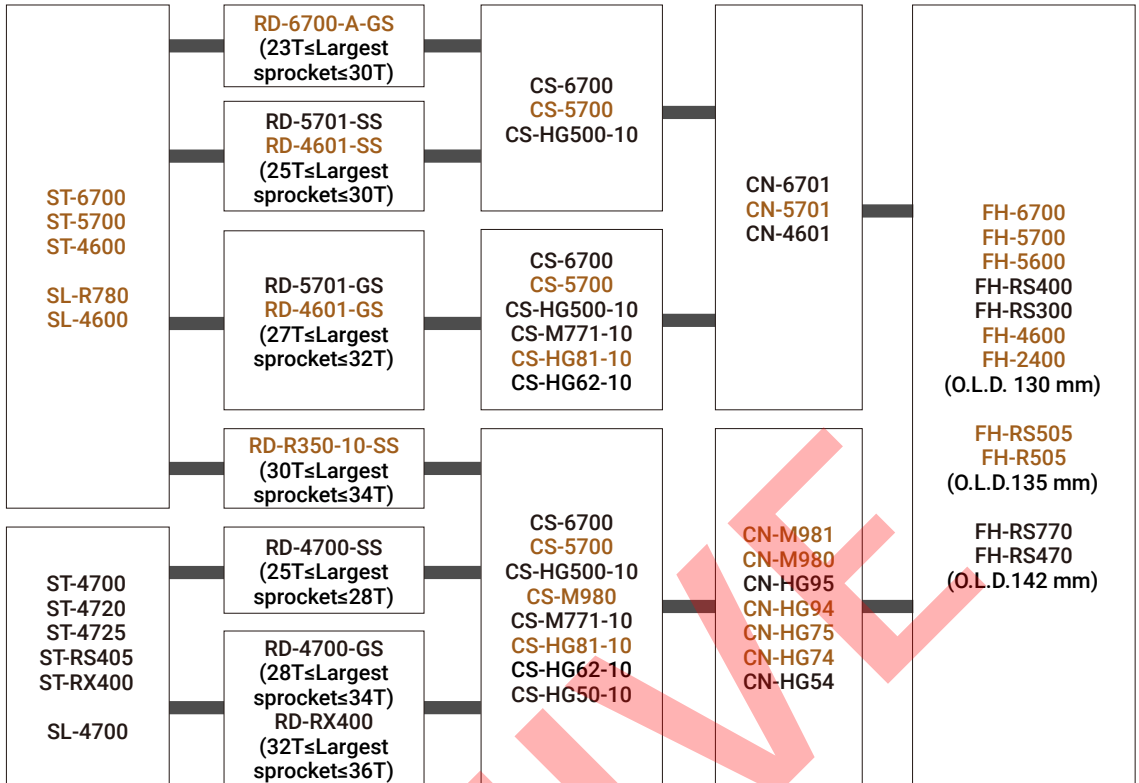

**3x10-speed**

**ULTEGRA  
6700**

**SHIMANO 105  
5700**

**TIAGRA  
4700  
4600**

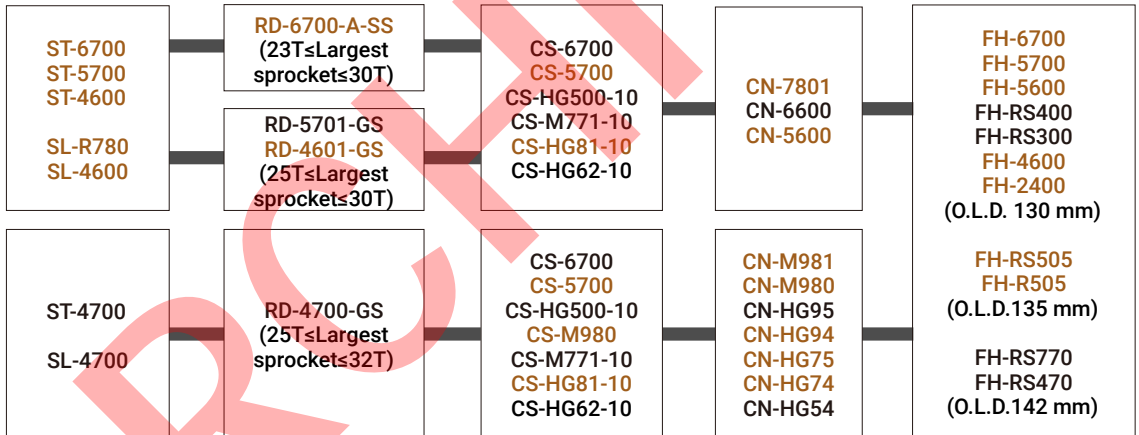

**2x10-speed  
LINKGLIDE**

**CUES  
U6000**

**1x10-speed  
LINKGLIDE**

**CUES  
U6000**

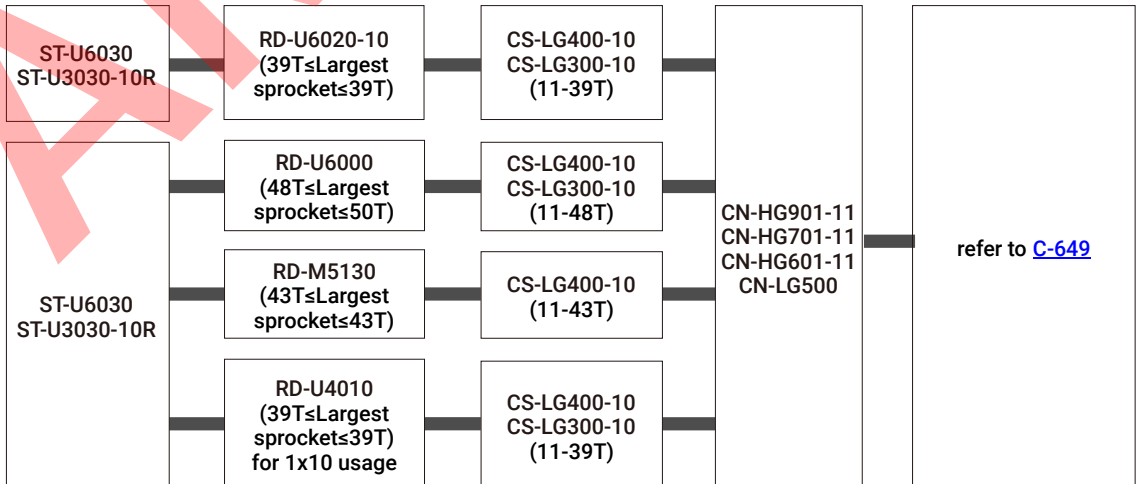



**2x9-speed**

**SORA  
R3000  
3500**

ST-R3000  
ST-3500

SL-R3000  
SL-3500

RD-R3000-SS  
(25T≤Largest  
sprockets≤32T)

RD-R3000-GS  
(28T≤Largest  
sprockets≤34T)

CS-HG400-9  
CS-HG300-9  
CS-HG50-9  
CS-HG30-9  
CS-HG20-9

CN-7701  
CN-HG93  
CN-HG73  
CN-HG53

FH-6700  
FH-5700  
FH-5600  
FH-RS400  
FH-RS300  
FH-4600  
FH-2400  
(O.L.D. 130 mm)

FH-RS505  
FH-R505  
(O.L.D.135 mm)

**3x9-speed**

**SORA  
3500**

ST-R350

RD-R350-GS  
(25T≤Largest  
sprockets≤32T)

CS-HG400-9  
CS-HG300-9  
CS-HG50-9  
CS-HG30-9  
CS-HG20-9

CN-7701  
CN-HG93  
CN-HG73  
CN-HG53

FH-6700  
FH-5700  
FH-5600  
FH-RS400  
FH-RS300  
FH-4600  
FH-2400  
(O.L.D. 130 mm)

FH-RS505  
FH-R505  
(O.L.D.135 mm)

**2x9-speed  
LINKGLIDE**

**CUES  
U4000**

ST-U3030-9R

RD-U4020  
RD-U3020  
(36T≤Largest  
sprockets≤36T)

CS-LG400-9  
CS-LG300-9  
(11-36T)

CN-HG901-11  
CN-HG701-11  
CN-HG601-11  
CN-LG500

**1x9-speed  
LINKGLIDE**

**CUES  
U4000**

ST-U3030-9R

RD-U4000  
(41T≤Largest  
sprockets≤46T)

CS-LG400-9  
CS-LG300-9  
(11-41T, 11-46T)

RD-U4010  
(36T≤Largest  
sprockets≤36T)  
for 1x9 usage

CS-LG400-9  
CS-LG300-9  
(11-36T)

refer to [C-649](#)



**2x8-speed**  
SHIMANO CLARIS  
R2000  
2400

ST-2400  
ST-R240  
ST-R2000  
ST-RS200

RD-2400-SS  
RD-R2000-SS  
(25T≤Largest  
sprockets≤32T)

CS-HG50-8  
(11-28T, 11-30T, 11-32T,  
12-25T, 13-26T)

**3x8-speed**  
SHIMANO CLARIS  
2400

SL-2400  
SL-R2000

RD-R2000-GS  
(28T≤Largest  
sprockets≤34T)

CS-HG50-8  
(11-28T, 11-30T, 11-32T,  
11-34T)

FH-6700  
FH-5700  
FH-5600  
FH-RS400  
FH-RS300  
FH-4600  
FH-2400  
(O.L.D. 130 mm)

FH-QC400-HM  
FH-QC300-HM  
FH-QB400-HM  
FH-NN300-HM  
FH-RS505  
FH-R505  
(O.L.D.135 mm)  
FH-TC500-HM  
FH-RS470  
(O.L.D.142 mm)

FH-6700  
FH-5700  
FH-5600  
FH-RS400  
FH-RS300  
FH-4600  
FH-2400  
(O.L.D. 130 mm)

FH-QC400-HM  
FH-QC300-HM  
FH-QB400-HM  
FH-NN300-HM  
FH-RS505  
FH-R505  
(O.L.D.135 mm)  
FH-TC500-HM  
FH-RS470  
(O.L.D.142 mm)

FH-RM30-7  
FH-TY500-7-QR(130)  
FH-TY500-7-NT(130)  
(O.L.D. 130 mm)

RH-IM10  
(O.L.D. 130 mm)  
RH-IM11  
(O.L.D. 134.7 mm)

**2/3x8-speed**  
2300

ST-2300

RD-2300  
(21T≤Largest  
sprockets≤26T)

CS-HG50-8  
(12-23T, 12-25T, 13-26T)

**1x8-speed**  
SHIMANO ESSA  
U2000

ST-U2030-R

RD-U2000  
(45T≤Largest  
sprockets≤45T)

CS-HG400-8  
CS-HG300-8  
(11-45T)

RD-M3020-8  
(30T≤Largest  
sprockets≤40T)

CS-HG400-8  
(11-40T)

CS-HG41-8  
CS-HG31-8  
(11-34T)

RD-M360-SGS  
RD-M310-Smart  
RD-TX800-SGS  
(28T≤Largest  
sprockets≤34T)

CS-HG51-8  
(11-28T, 11-30T, 11-32T)  
CS-HG41-8  
CS-HG31-8  
(11-30T, 11-32T)  
CS-HG200-8  
(12-32T)

CN-HG91  
CN-HG71  
CN-HG50  
CN-HG40  
CN-UG51

**2/3x7-speed**  
TOURNEY  
A070  
A050

ST-A070

RD-A070

CS-HG210-7(12-28T)  
CS-HG400-7(11-28T)  
\* Only compatible with  
direct attachment type  
derailleur

CN-HG71  
CN-HG50  
CN-HG40  
CN-UG51

CS-HG200-7(12-28T)  
CS-HG41-7(11-28T)

CN-HG71  
CN-HG50  
CN-HG40  
CN-UG51

MF-TZ500-7(14-28T)  
MF-TZ510-7(14-28T)  
MF-TZ21(14-28T)  
MF-HG37(13-28T)

CN-HG71  
CN-HG50  
CN-HG40  
CN-UG51

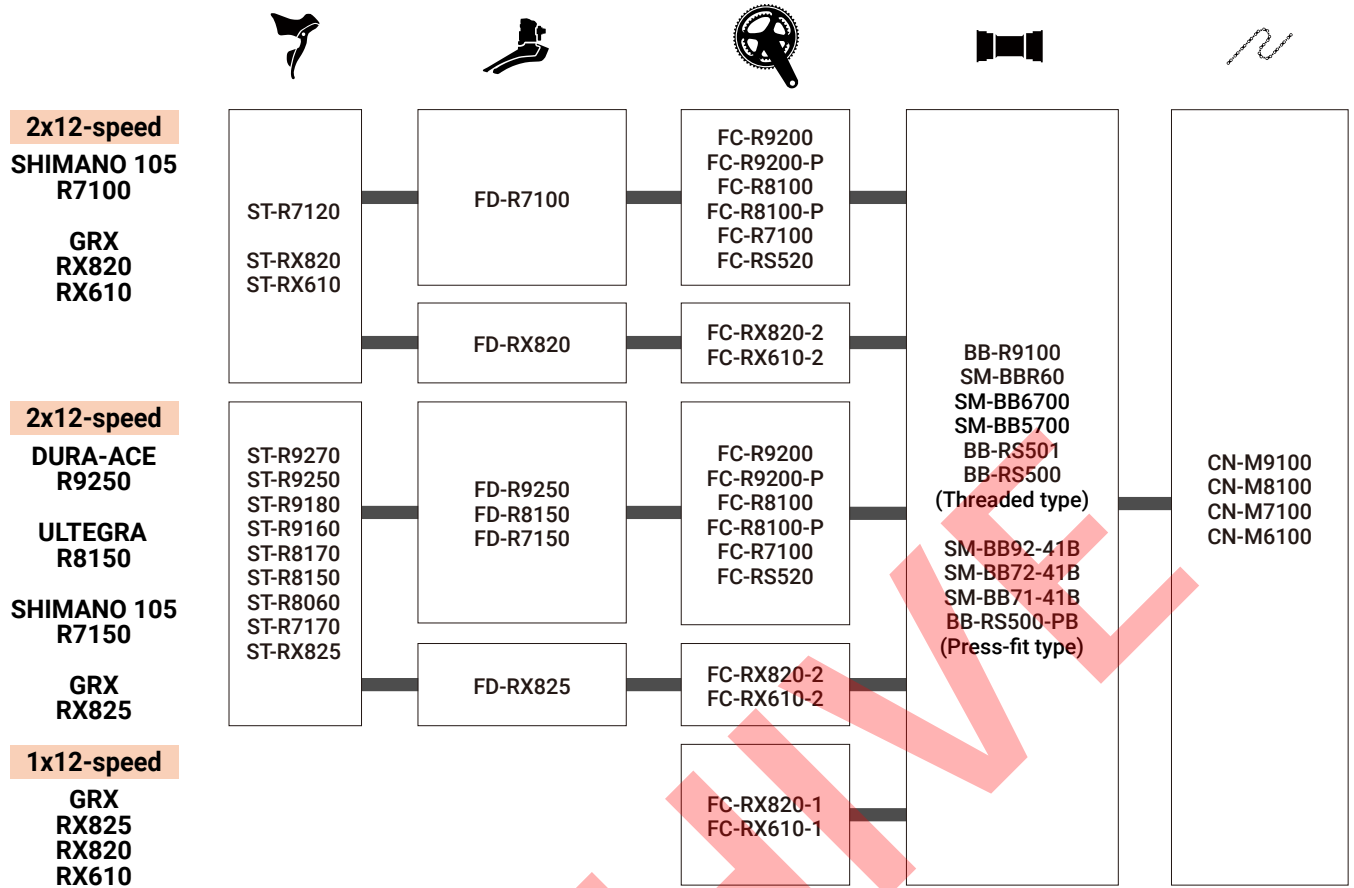



**2x11-speed**  
**DURA-ACE**  
 R9100  
 9000

**ULTEGRA**  
 R8000  
 6800

**SHIMANO 105**  
 R7000  
 5800

**TIAGRA**  
 R4000

**GRX**  
 RX810  
 RX600

**METREA**  
 U5000

ST-R9100  
 ST-R9120  
 ST-9001  
 ST-9000  
 SL-BSR1  
 ST-R8000  
 ST-R8020  
 ST-R8025  
 ST-6800  
 ST-5800  
 ST-R7000  
 ST-R7020  
 ST-R7025  
 ST-RS685  
 ST-RS505  
 ST-U5060  
 SL-RS700  
 SL-U5000  
 ST-RX810  
 ST-RX600

FD-R9100  
 (not compatible  
 with 46T)  
 FD-R8000  
 FD-5801  
 FD-R7000

FD-9000  
 (not compatible  
 with 46T)  
 FD-6800  
 FD-5800  
 FD-U5000

FD-RX810

FD-R9150  
 (not compatible  
 with 46T)  
 FD-R8050

FD-9070  
 FD-6870

FD-RX815

ST-R4020

FD-R4000

FC-R9100  
 FC-09  
 FC-R9100-P  
 FC-R9200-PX  
 FC-R8000  
 FC-08  
 FC-R7000  
 FC-RS510

FC-9000  
 FC-09  
 FC-6800  
 FC-08  
 FC-5800  
 FC-RS500  
 FC-U5000-2

FC-RX810-2  
 FC-RX600-11

FC-R9100  
 FC-09  
 FC-R9100-P  
 FC-R9200-PX  
 FC-R8000  
 FC-08  
 FC-R7000  
 FC-RS510

FC-9000  
 FC-09  
 FC-6800  
 FC-08  
 FC-5800  
 FC-RS500  
 FC-U5000-2

FC-RX810-2  
 FC-RX600-11

ST-R4020

FD-R4000

FC-R4000

BB-R9100  
 SM-BBR60  
 SM-BB6700  
 SM-BB5700  
 BB-RS501  
 BB-RS500  
 (Threaded type)

SM-BB92-41B  
 SM-BB72-41B  
 SM-BB71-41B  
 BB-RS500-PB  
 (Press-fit type)

CN-HG901-11  
 CN-HG701-11  
 CN-HG601-11

CN-LG500

**1x11-speed**  
**GRX**  
 RX810  
 RX600

**METREA**  
 U5000

FC-RX810-1  
 FC-RX600-1

FC-U5000-1

FC-U6040-1  
 FC-U6030-1

FC-U4000-1  
 FC-UT400-1

BB-R9100  
 SM-BBR60  
 SM-BB6700  
 SM-BB5700  
 BB-RS501  
 BB-RS500  
 (Threaded type)

SM-BB92-41B  
 SM-BB72-41B  
 SM-BB71-41B  
 BB-RS500-PB  
 (Press-fit type)

CN-HG901-11  
 CN-HG701-11  
 CN-HG601-11

CN-LG500

**1x11-speed**  
**LINKGLIDE**  
**CUES**  
 U6000

BB-UN55  
 BB-UN26  
 BB-UN101  
 BB-UN300  
 (Square type)

CN-LG500



**2x10-speed**

**ULTEGRA  
6700**

**SHIMANO 105  
5700**

**TIAGRA  
4700  
4600**

**GRX  
RX400**

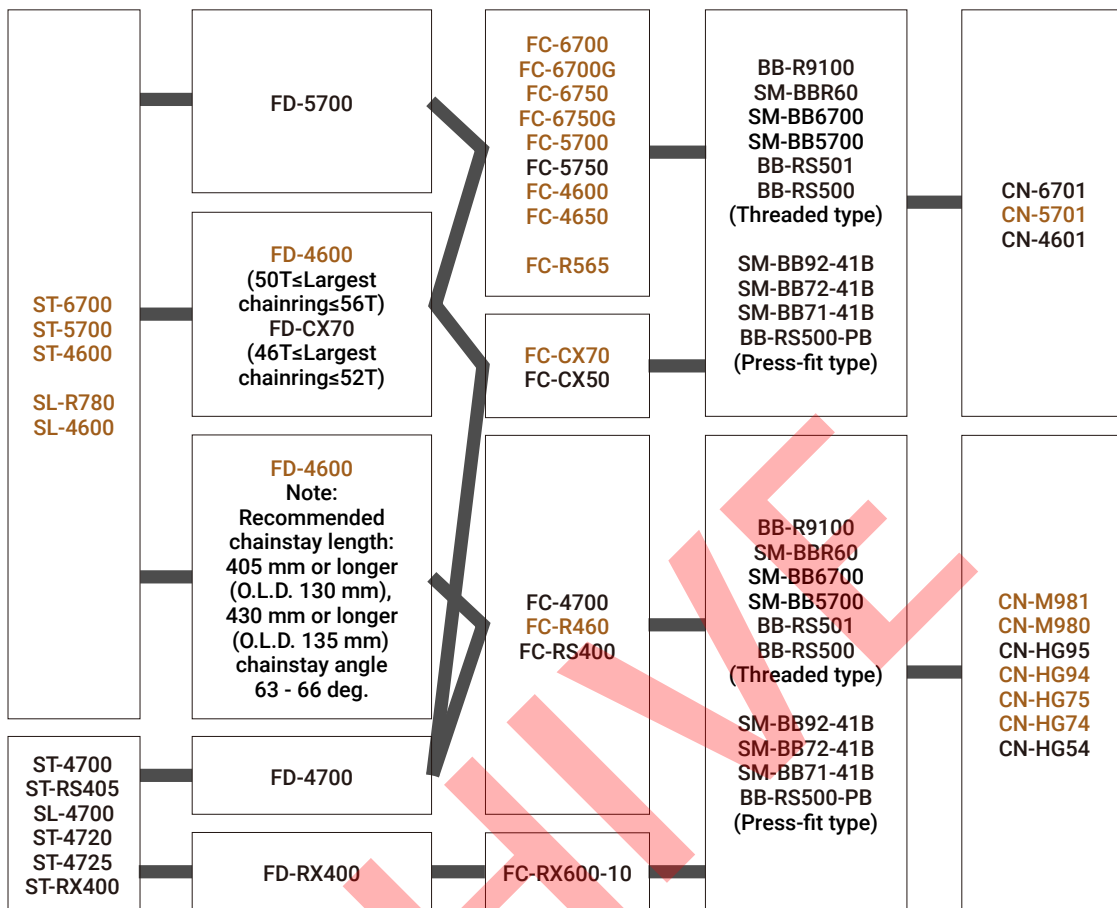



**3x10-speed**  
**ULTEGRA**  
**6703**

**SHIMANO 105**  
**5703**

**TIAGRA**  
**4703**  
**4603**

ST-4703  
SL-4703

FD-4703

FC-4703

BB-R9100  
SM-BBR60  
SM-BB6700  
SM-BB5700  
BB-RS501  
BB-RS500  
(Threaded type)

CN-M981  
CN-M980  
CN-HG95  
CN-HG94  
CN-HG75  
CN-HG74  
CN-HG54

ST-6703  
ST-5703  
ST-4603

SL-R783  
SL-4603

FD-5703  
FD-4603

FC-5703

SM-BB92-41B  
SM-BB72-41B  
SM-BB71-41B  
BB-RS500-PB  
(Press-fit type)

CN-7801  
CN-6600  
CN-5600

**2x10-speed**  
**LINKGLIDE**

**CUES**  
**U6000**

ST-U6030  
ST-U3030

FD-U6030

FC-U6040-2  
FC-U6030-2

BB-R9100  
SM-BBR60  
SM-BB6700  
SM-BB5700  
BB-RS501  
BB-RS500  
(Threaded type)

**1x10-speed**  
**LINKGLIDE**

**CUES**  
**U6000**

FC-U6040-1  
FC-U6030-1

SM-BB92-41B  
SM-BB72-41B  
SM-BB71-41B  
BB-RS500-PB  
(Press-fit type)

CN-HG901-11  
CN-HG701-11  
CN-HG601-11  
CN-LG500

FC-U4000-1  
FC-UT400-1

BB-UN55  
BB-UN26  
BB-UN101  
BB-UN300  
(Square type)

ARCHIVE



**2x9-speed**  
SORA  
R3000  
3500

ST-3500  
SL-3500

FD-3500

FC-R450  
FC-R345

BB-ES300  
(OCTALINK)

**3x9-speed**  
SORA  
R3030  
3500

ST-R3030  
ST-3503  
SL-R3030  
SL-3503

FD-R3030

FC-R3000  
FC-3550  
FC-R350

BB-R9100  
SM-BBR60  
SM-BB6700  
SM-BB5700  
BB-RS501  
BB-RS500  
(Threaded type)  
  
SM-BB92-41B  
SM-BB72-41B  
SM-BB71-41B  
BB-RS500-PB  
(Press-fit type)

CN-7701  
CN-HG93  
CN-HG73  
CN-HG53

**2x9-speed**  
LINKGLIDE  
CUES  
U4000

ST-U3030

FD-U6030

FC-U6040-2  
FC-U6030-2

BB-R9100  
SM-BBR60  
SM-BB6700  
SM-BB5700  
BB-RS501  
BB-RS500  
(Threaded type)

**1x9-speed**  
LINKGLIDE  
CUES  
U4000

FC-U6040-1  
FC-U6030-1

SM-BB92-41B  
SM-BB72-41B  
SM-BB71-41B  
BB-RS500-PB  
(Press-fit type)

CN-HG901-11  
CN-HG701-11  
CN-HG601-11  
CN-LG500

FC-U4000-1  
FC-UT400-1

BB-UN55  
BB-UN26  
BB-UN101  
BB-UN300  
(Square type)

ARCHIVE



*2*

**2x8-speed**  
**SHIMANO CLARIS**  
 R2000  
 2400  
 2300

ST-2400  
 ST-2300  
 ST-R240  
 SL-2400

FD-2400  
 FD-2300

FC-2450  
 FC-R2000

BB-ES300  
 (OCTALINK)

ST-R2000  
 ST-RS200  
 SL-R2000

FD-R2000

FC-2300  
 FC-2350  
 FC-RS200

BB-R9100  
 SM-BBR60  
 SM-BB6700  
 SM-BB5700  
 BB-RS501  
 BB-RS500  
 (Threaded type)  
 SM-BB92-41B  
 SM-BB72-41B  
 SM-BB71-41B  
 BB-RS500-PB  
 (Press-fit type)

SL-R441  
 ST-R221

FD-R440A

FC-2300  
 FC-2350

**3x8-speed**  
**SHIMANO CLARIS**  
 R2030  
 2400  
 2300

ST-2403  
 ST-2303  
 SL-2403  
 ST-R243  
 ST-R2030  
 SL-R2030  
 ST-RS203

FD-2403  
 FD-2303  
 FD-R2030

FC-R2030  
 FC-2403  
 FC-2303

BB-UN26  
 BB-UN300  
 (Square type)

CN-HG91  
 CN-HG71  
 CN-HG50  
 CN-HG40  
 CN-UG51

ST-R225

FD-R443A

FC-2303

BB-ES300  
 (OCTALINK)

**1x8-speed**  
**SHIMANO ESSA**  
 U2000

FC-U2001-1  
 FC-U2000-1

BB-UN100  
 (Square type)

**2x7-speed**  
**TOURNEY**  
 A070  
 A050

ST-A070  
 SL-A050-LN  
 SL-SY20A

FD-A070A  
 FD-A050

FC-A070 (50-34T)

BB-UN26  
 BB-UN300  
 (Square type)

**3x7-speed**  
**TOURNEY**  
 A070

ST-A073

FD-A073

FC-A073

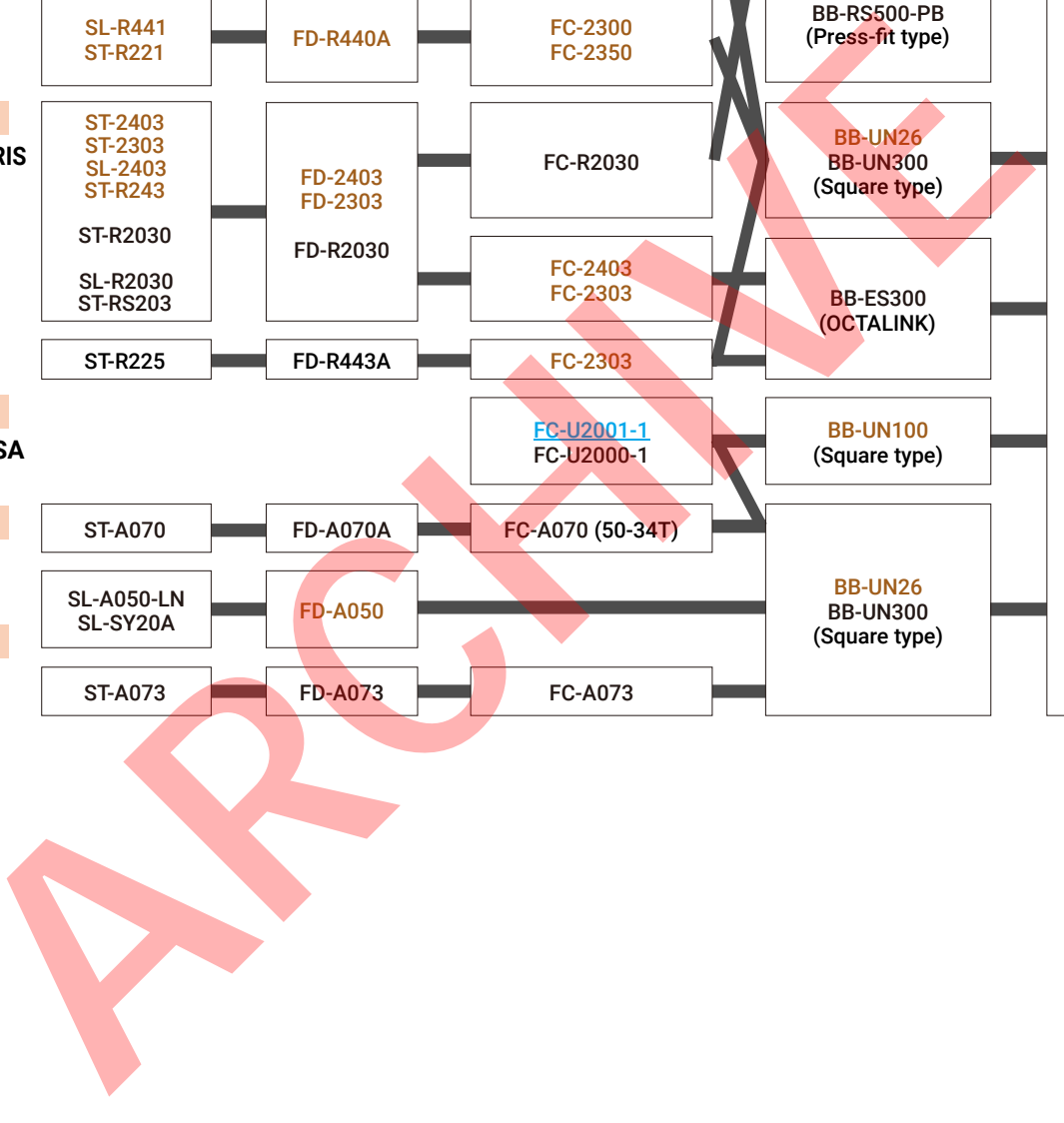

# Brake system for ROAD, Gravel, LIFESTYLE components

C-737

## Brake systems compatibility [ROAD, LIFESTYLE]

C-456

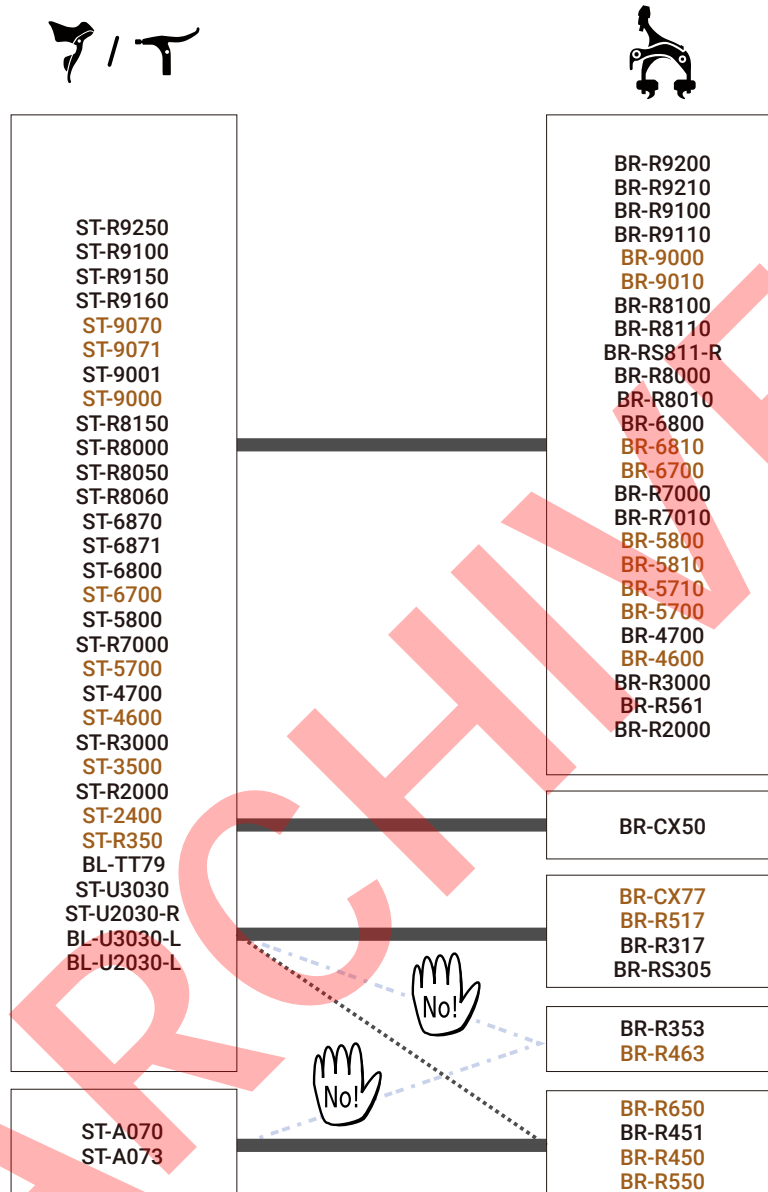

..... : Braking power is slightly less than standard combination.

: The "NO!" symbols indicate combinations that should not be used under any circumstances.

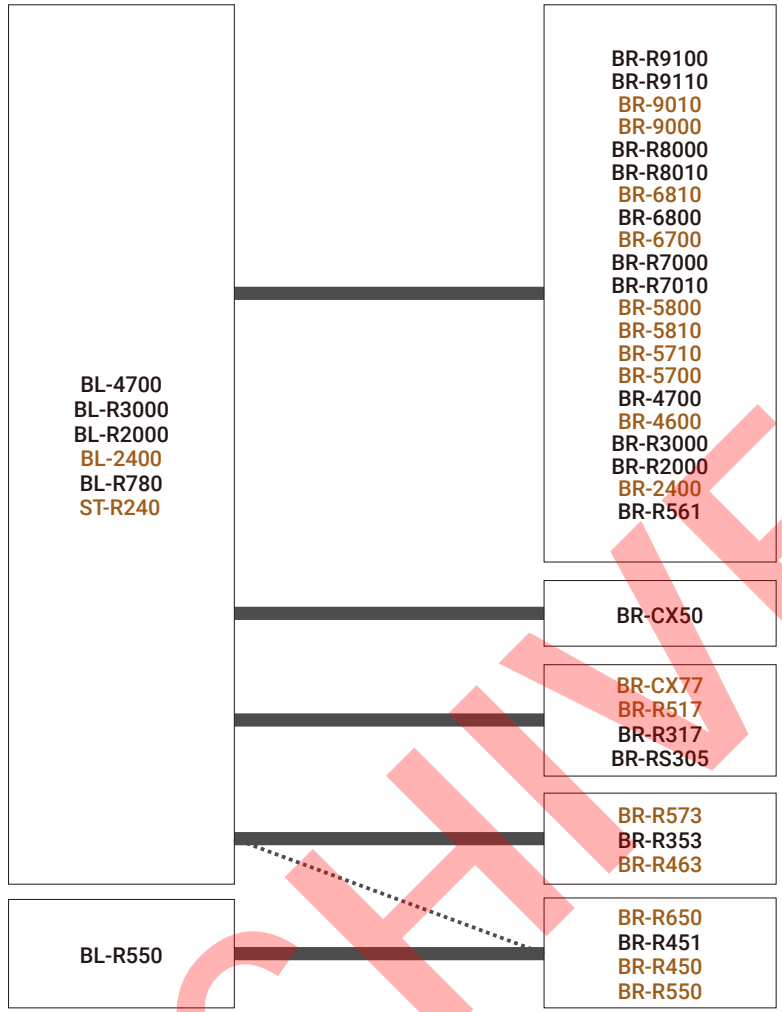

..... : Braking power is slightly less than standard combination.

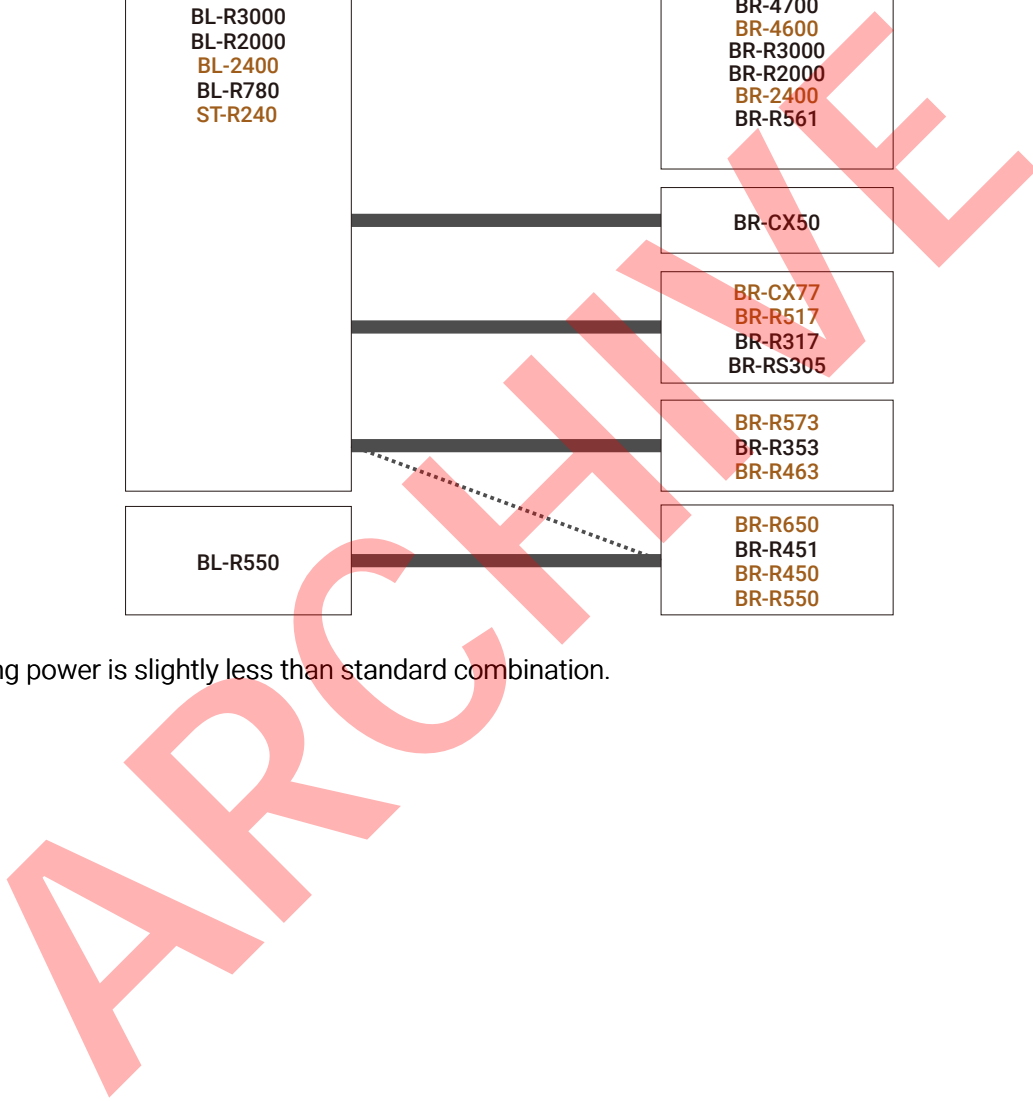

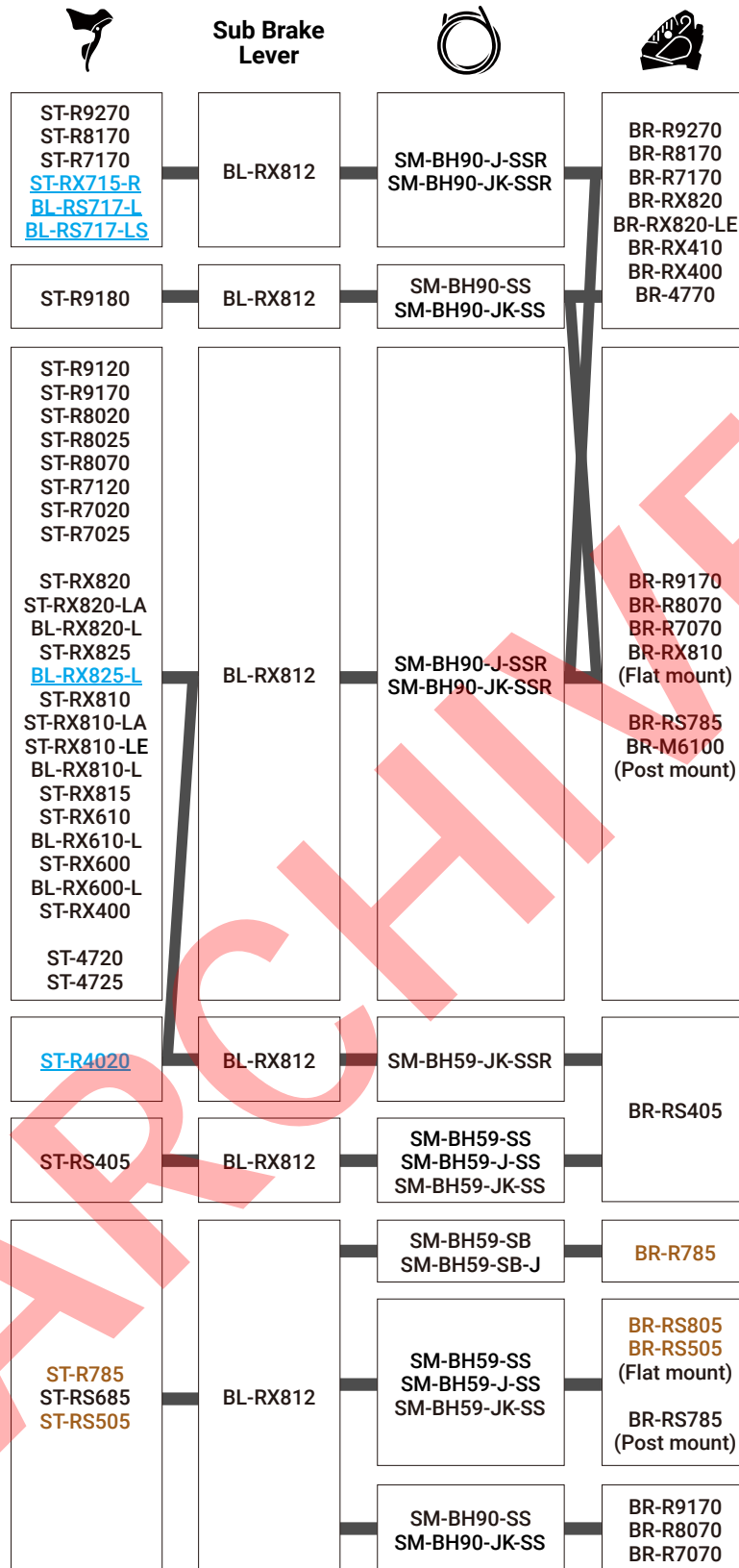

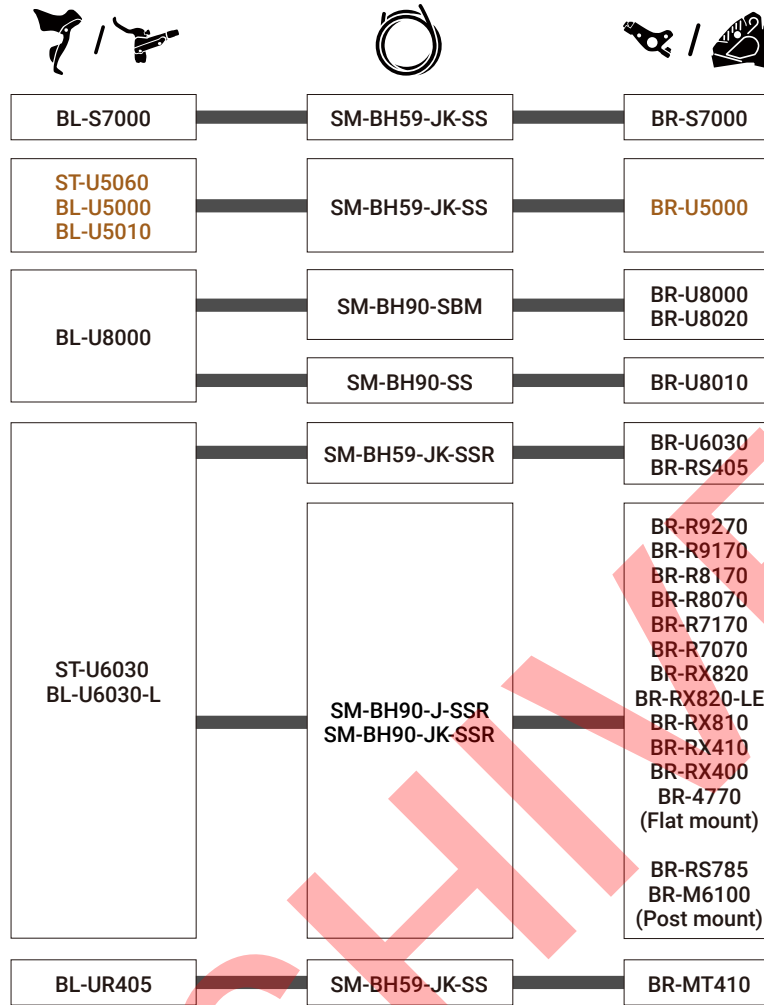

# Compatibility of BL-U8000 with shifter

## Shifters compatible with BL-U8000

Series	Model No.
DEORE XT	SL-M8130-R
	SL-M8100-R
SLX	SL-M7100-R
DEORE	SL-M6100-R (w/o OPTICAL GEAR DISPLAY)
	SL-M5130-R (w/o OPTICAL GEAR DISPLAY)
	SL-M5100-R (w/o OPTICAL GEAR DISPLAY)
	SL-M4100-R (w/o OPTICAL GEAR DISPLAY)
CUES	SL-U8000-L / SL-U8000-11R
	SL-U8000-IL / SL-U8000-11IR

## BL-U8000 compatibility with shifters not listed in the table above

### Clamp band type

Shifter type	Specification	Compatibility with BL-U8000
REVOSHIFT	-	Not compatible
RAPIDFIRE PLUS RAPIDFIRE PLUS MONO Thumb Shifter PLUS	w/o OPTICAL GEAR DISPLAY	*1
	w/ OPTICAL GEAR DISPLAY on top *2	Not compatible
	w/ OPTICAL GEAR DISPLAY on bottom *2	*1

### I-SPEC type

Mount type	Compatibility
I-SPEC	Not compatible
I-SPEC II	*1
I-SPEC EV	Not compatible

\*1 Please contact SHIMANO sales office

\*2

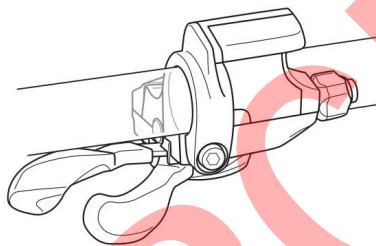

w/ OPTICAL GEAR DISPLAY on top

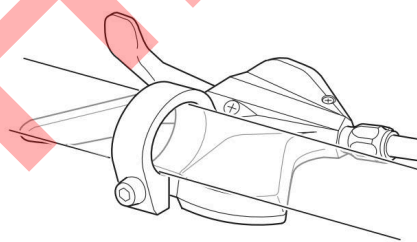

w/ OPTICAL GEAR DISPLAY on bottom

# Compatibility of BL-UR405 with shifter

## Shifters compatible with BL-UR405

Series	Model No.
CUES	SL-U6050-11R
	SL-U6050-10R
	SL-U4050-9R

## Compatibility of I-SPEC shifter and brake lever

C-157

With the exceptions noted below, clamp band type shifters are compatible as I-SPEC if the upper body is replaced with an integral unit.

- RAPIDFIRE PLUS MONO Shifter
- SL-U8000

### I-SPEC EV shifter

	Model No.	SL-M9100-I	SL-M8100-I	SL-M7100-I	SL-M6100-I	SL-M5100-I	SL-M4100-I	SL-M8130-I
I-SPEC EV	<a href="#">BL-M9200</a>	✓	✓	✓	✓	✓	✓	✓
	<a href="#">BL-M9220</a>	✓	✓	✓	✓	✓	✓	✓
	BL-M9100	✓	✓	✓	✓	✓	✓	✓
	BL-M9120	✓	✓	✓	✓	✓	✓	✓
	<a href="#">BL-M8200</a>	✓	✓	✓	✓	✓	✓	✓
	BL-M8100	✓	✓	✓	✓	✓	✓	✓
	BL-M7100	✓	✓	✓	✓	✓	✓	✓
	BL-M6100	✓	✓	✓	✓	✓	✓	✓
	BL-M4100	✓	✓	✓	✓	✓	✓	✓
I-SPEC II	<a href="#">BL-M9000</a>	-	-	-	-	-	-	-
	<a href="#">BL-M9020</a>	-	-	-	-	-	-	-
	BL-M8000	-	-	-	-	-	-	-
	BL-T8100	-	-	-	-	-	-	-
	BL-T8000	-	-	-	-	-	-	-
	<a href="#">BL-M7000</a>	-	-	-	-	-	-	-
	<a href="#">BL-M6000</a>	-	-	-	-	-	-	-
	BL-T6000	-	-	-	-	-	-	-
	BL-RS600	-	-	-	-	-	-	-
	<a href="#">BL-MT500</a>	-	-	-	-	-	-	-
	BL-MT501	-	-	-	-	-	-	-
BL-U8000 *1	-	-	-	-	-	-	-	
	<a href="#">BL-U5000</a>	-	-	-	-	-	-	-
I-SPEC B	BL-M820-B	-	-	-	-	-	-	-

\*1 As for the compatibility between BL-U8000 and mechanical shifter, please refer to the [C-738](#).

### I-SPEC II shifter

	Model No.	<a href="#">SL-M9000-I</a>	<a href="#">SL-M8000-I</a>	<a href="#">SL-M7000-11-I</a> <a href="#">SL-M7000-10-I</a>	<a href="#">SL-U5000</a>	SL-M6000-I	SL-RS700-I	SL-U8000-I
I-SPEC EV	<a href="#">BL-M9200</a>	-	-	-	-	-	-	-
	<a href="#">BL-M9220</a>	-	-	-	-	-	-	-
	BL-M9100	-	-	-	-	-	-	-
	BL-M9120	-	-	-	-	-	-	-
	<a href="#">BL-M8200</a>	-	-	-	-	-	-	-
	BL-M8100	-	-	-	-	-	-	-
	BL-M7100	-	-	-	-	-	-	-
	BL-M6100	-	-	-	-	-	-	-
	BL-M4100	-	-	-	-	-	-	-
I-SPEC II	<a href="#">BL-M9000</a>	✓	✓	✓	✓	✓	✓	✓
	<a href="#">BL-M9020</a>	✓	✓	✓	✓	✓	✓	✓
	BL-M8000	✓	✓	✓	✓	✓	✓	✓
	BL-T8100	✓	✓	✓	✓	✓	✓	✓
	BL-T8000	✓	✓	✓	✓	✓	✓	✓
	<a href="#">BL-M7000</a>	✓	✓	✓	✓	✓	✓	✓
	<a href="#">BL-M6000</a>	✓	✓	✓	✓	✓	✓	✓
	BL-T6000	✓	✓	✓	✓	✓	✓	✓
	BL-RS600	✓	✓	✓	✓	✓	✓	✓
	<a href="#">BL-MT500</a>	✓	✓	✓	✓	✓	✓	✓
	BL-MT501	✓	✓	✓	✓	✓	✓	✓
BL-U8000 *1	-	-	-	-	-	-	-	
	<a href="#">BL-U5000</a>	✓	✓	✓	✓	✓	✓	
I-SPEC B	BL-M820-B	-	-	-	-	-	-	-

\*1 As for the compatibility between BL-U8000 and mechanical shifter, please refer to the [C-738](#).

## I-SPEC B shifter

	Model No.	SL-M8000-B-I	SL-M7000-11 SL-M7000-10-B-I	SL-M820-B-I SL-M820 (with SM-SL82-B)
I-SPEC EV	<a href="#">BL-M9200</a>	-	-	-
	<a href="#">BL-M9220</a>	-	-	-
	BL-M9100	-	-	-
	BL-M9120	-	-	-
	<a href="#">BL-M8200</a>	-	-	-
	BL-M8100	-	-	-
	BL-M7100	-	-	-
	BL-M6100	-	-	-
I-SPEC II	BL-M4100	-	-	-
	<a href="#">BL-M9000</a>	-	-	-
	<a href="#">BL-M9020</a>	-	-	-
	BL-M8000	-	-	-
	BL-T8100	-	-	-
	BL-T8000	-	-	-
	<a href="#">BL-M7000</a>	-	-	-
	<a href="#">BL-M6000</a>	-	-	-
	BL-T6000	-	-	-
	BL-RS600	-	-	-
	<a href="#">BL-MT500</a>	-	-	-
BL-MT501	-	-	-	
BL-U8000 *1	-	-	-	
<a href="#">BL-U5000</a>	-	-	-	
I-SPEC B	BL-M820-B	✓	✓	✓

\*1 As for the compatibility between BL-U8000 and mechanical shifter, please refer to the [C-738](#).

## Compatibility of seat post lever and brake lever

	Model No.	SL-MT800	SL-MT500-I
I-SPEC EV	<a href="#">BL-M9200</a>	✓	✓
	<a href="#">BL-M9220</a>	✓	✓
	BL-M9100	✓	✓
	BL-M9120	✓	✓
	<a href="#">BL-M8200</a>	✓	✓
	BL-M8100	✓	✓
	BL-M7100	✓	✓
	BL-M6100	✓	✓
I-SPEC II	BL-M4100	✓	✓
	<a href="#">BL-M9000</a>	-	-
	<a href="#">BL-M9020</a>	-	-
	BL-M8000	-	-
	BL-T8100	-	-
	BL-T8000	-	-
	<a href="#">BL-M7000</a>	-	-
	<a href="#">BL-M6000</a>	-	-
	BL-T6000	-	-
	BL-RS600	-	-
	<a href="#">BL-MT500</a>	-	-
BL-MT501	-	-	
BL-U8000	-	-	
<a href="#">BL-U5000</a>	-	-	
I-SPEC B	BL-M820-B	-	-

# Compatibility of Shift Switch and I-SPEC brake lever

For SHIMANO E-BIKE SYSTEMS switch unit, refer to [C-421](#)

## I-SPEC EV type brake lever

Model No.	<a href="#">SW-M9250-IR</a>	<a href="#">SW-M8250-IR</a>	<a href="#">SW-M6250-IR</a>	SW-M8150-IR	SW-M9050	SW-M8050	SW-EN605-R
<a href="#">BL-M9200</a>	✓	✓	✓	✓	-	-	✓
<a href="#">BL-M9220</a>	✓	✓	✓	✓	-	-	✓
BL-M9100	✓	✓	✓	✓	-	-	✓
BL-M9120	✓	✓	✓	✓	-	-	✓
<a href="#">BL-M8200</a>	✓	✓	✓	✓	-	-	✓
BL-M8100	✓	✓	✓	✓	-	-	✓
BL-M7100	✓	✓	✓	✓	-	-	✓
BL-M6100	✓	✓	✓	✓	-	-	✓
BL-M4100	✓	✓	✓	✓	-	-	✓

## I-SPEC II type brake lever

Model No.	<a href="#">SW-M9250-R</a>	<a href="#">SW-M8250-R</a>	<a href="#">SW-M6250-R</a>	SW-M8150-R	SW-M9050	SW-M8050	SW-EN605-R
<a href="#">BL-M9000</a>	✓	✓	✓	✓	✓	✓	✓
<a href="#">BL-M9020</a>	✓	✓	✓	✓	✓	✓	✓
BL-M8000	✓	✓	✓	✓	✓	✓	✓
BL-T8100	✓	✓	✓	✓	✓	✓	✓
BL-T8000	✓	✓	✓	✓	✓	✓	✓
<a href="#">BL-M7000</a>	✓	✓	✓	✓	✓	✓	✓
<a href="#">BL-M6000</a>	✓	✓	✓	✓	✓	✓	✓
BL-T6000	✓	✓	✓	✓	✓	✓	✓
BL-RS600	✓	✓	✓	✓	✓	✓	✓
<a href="#">BL-MT500</a>	✓	✓	✓	✓	✓	✓	✓
BL-MT501	✓	✓	✓	✓	✓	✓	✓
BL-U8000	✓	✓	✓	✓	-	-	✓
<a href="#">BL-U5000</a>	✓	✓	✓	✓	✓	✓	✓

## I-SPEC B type brake lever

Model No.	<a href="#">SW-M9250-R</a>	<a href="#">SW-M8250-R</a>	<a href="#">SW-M6250-R</a>	SW-M8150-R	SW-M9050	SW-M8050	SW-EN605-R
BL-M820-B	✓	✓	✓	✓	✓	✓	✓

## Other clamp band type brake lever

### SW-M8150-R / SW-M9050 / SW-M8050 / SW-EN605-R

Model No.	SW-M8150-R	SW-M9050	SW-M8050	SW-EN605-R
BL-MT402-3A	✓	✓	✓	✓
<a href="#">BL-MT402-ABS</a>	✓	✓	✓	✓
BL-MT401	✓	✓	✓	✓
BL-MT201	✓	✓	✓	✓
BL-MT200	✓	✓	✓	✓
<a href="#">BL-MT200-ABS</a>	✓	✓	✓	✓

## SHIMANO brake oil compatibility

C-736

Do not use oils other than those specified by SHIMANO. Doing so may prevent the brakes from operating and result in serious injury due to a fall or collision.

### SHIMANO LOW VISCOSITY OIL dedicated models

Brake lever	Brake caliper
<a href="#">BL-M9200</a>	<a href="#">BR-M9200</a>
	<a href="#">BR-MT805</a>
<a href="#">BL-M9220</a>	<a href="#">BR-M9220</a>
	<a href="#">BR-M9200</a>
	<a href="#">BR-MT805</a>
<a href="#">BL-M8200</a>	<a href="#">BR-M8200</a>
	<a href="#">BR-M8220</a>
	<a href="#">BR-MT805</a>

#### NOTE

The following can use the same product for SHIMANO LOW VISCOSITY OIL and SHIMANO mineral oil.

- Brake hose
- Connector insert
- Flare nut
- Olive
- SHIMANO bleeding tools (TL-BR001/TL-BR003)

# Disc brake caliper and rotor compatibility

Brake caliper	Brake pad material	Pad type	Rotor				
			220 mm (LL)	203 mm (L)	180 mm (M)	160 mm (S)	140 mm (SS)
<a href="#">BR-M9200</a> *4 <a href="#">BR-M9220</a> *8 BR-M9100*4 BR-M9110*5 BR-M9120*8 <a href="#">BR-M8200</a> <a href="#">BR-M8220</a> *8 BR-M8100 BR-M8110*6 BR-M8120 BR-M8000 BR-M8020 BR-M7100 BR-M7110*6 BR-M7120 BR-M6100 BR-M6120 <a href="#">BR-MT805</a> *6 BR-MT520 BR-MT420 BR-M820 BR-U8000 BR-U8010*4 BR-U8020	Metal / Resin	Narrow	SM-RT66 SM-RT64	RT-CL900 RT-CL800 RT-CL700 <a href="#">RT-CL300</a> *2 RT-MT905 RT-MT900 <a href="#">SM-RT99</a> RT-MT800 SM-RT86 <a href="#">SM-RT81</a> SM-RT76 SM-RT70 SM-RT66 SM-RT64 SM-RT56*2 SM-RT54*2 SM-RT30*2 SM-RT26*2 RT-EM910*1 <a href="#">RT-EM900</a> *1 RT-EM810*1 RT-EM600*1 RT-EM300*1*2	RT-CL900 RT-CL800 RT-CL700 <a href="#">RT-CL300</a> *2 RT-MT905 RT-MT900 <a href="#">SM-RT99</a> RT-MT800 SM-RT86 <a href="#">SM-RT81</a> SM-RT76 SM-RT70 SM-RT66 SM-RT64 SM-RT56*2 SM-RT54*2 SM-RT30*2 SM-RT26*2 RT-EM910*1 <a href="#">RT-EM900</a> *1 RT-EM810*1 <a href="#">RT-EM800</a> *1 RT-EM600*1 RT-EM300*1*2	RT-CL900 RT-CL800 RT-CL700 <a href="#">RT-CL300</a> *2 RT-MT900 SM-RT900 SM-RT800 <a href="#">SM-RT99</a> <a href="#">SM-RT99</a> RT-MT800 SM-RT86 <a href="#">SM-RT81</a> SM-RT76 SM-RT70 SM-RT66 SM-RT64 SM-RT60 SM-RT56*2 SM-RT54*2 SM-RT30*2 SM-RT26*2 SM-RT10*2 RT-EM910*1 <a href="#">RT-EM900</a> *1 <a href="#">RT-EM810</a> *1 <a href="#">RT-EM800</a> *1 RT-EM600*1 RT-EM300*1*2	RT-CL900 RT-CL800 RT-CL700 SM-RT900 RT-CL700 RT-MT900 SM-RT900 SM-RT800 SM-RT99 SM-RT99-A RT-MT800 SM-RT800 <a href="#">SM-RT81</a> SM-RT70 SM-RT64 SM-RT26*2
<a href="#">BR-S700</a> BR-S7000	Resin	-	-	-	-	-	-
BR-MT410	Resin	Wide	-	<a href="#">RT-CL300</a> SM-RT30 RT-EM300*1	-	-	-
<a href="#">BR-T675</a> <a href="#">BR-T615</a> <a href="#">BR-M4050</a> BR-MT500 <a href="#">BR-M446</a> <a href="#">BR-MT400</a> <a href="#">BR-M3050</a> BR-M375 BR-MT200 <a href="#">BR-M365</a> <a href="#">BR-M315</a> BR-TX805 BR-U6030*8 BR-UR300*8	Resin	Wide	-	-	<a href="#">RT-CL300</a> SM-RT56 SM-RT54 SM-RT30 SM-RT26 SM-RT10 RT-EM300*1	<a href="#">RT-CL300</a> SM-RT56 SM-RT54 SM-RT30 SM-RT26 SM-RT10 RT-EM300*1	SM-RT26
BR-R9270*7 BR-R9170*3 BR-R8170 BR-R8070 BR-R7170 BR-R7070 BR-4770 <a href="#">BR-RS805</a> <a href="#">BR-R785</a> BR-RS785 <a href="#">BR-RS505</a> BR-RS405*9 BR-RS305 BR-RX820 BR-RX820-LE BR-RX810 BR-RX410 BR-RX400	Metal / Resin	Narrow	-	-	RT-CL900 RT-CL800 RT-CL700 <a href="#">RT-CL300</a> *2 RT-MT905 RT-MT900 RT-MT800 <a href="#">SM-RT99</a> SM-RT86 <a href="#">SM-RT81</a> SM-RT76 SM-RT70 SM-RT66 SM-RT64 SM-RT56*2 SM-RT54*2 SM-RT30*2 SM-RT26*2 SM-RT10*2 RT-EM910*1 <a href="#">RT-EM900</a> *1 RT-EM810*1 <a href="#">RT-EM800</a> *1 RT-EM600*1 RT-EM300*1*2	RT-CL900 RT-CL800 RT-CL700 <a href="#">RT-CL300</a> *2 RT-MT900 SM-RT900 SM-RT800 <a href="#">SM-RT99</a> SM-RT86 <a href="#">SM-RT81</a> SM-RT76 SM-RT70 SM-RT66 SM-RT64 SM-RT56*2 SM-RT54*2 SM-RT30*2 SM-RT26*2 SM-RT10*2 RT-EM910*1 <a href="#">RT-EM900</a> *1 RT-EM810*1 <a href="#">RT-EM800</a> *1 RT-EM600*1 RT-EM300*1*2	RT-CL900 RT-CL800 RT-CL700 SM-RT900 RT-CL700 RT-MT900 SM-RT900 SM-RT800 SM-RT99 SM-RT99-A RT-MT800 SM-RT800 <a href="#">SM-RT81</a> SM-RT70 SM-RT64 SM-RT26*2
<a href="#">BR-CX77</a> <a href="#">BR-R517</a> BR-R317	Metal / Resin	Narrow	-	-	-	<a href="#">SM-RT99</a> SM-RT86 <a href="#">SM-RT81</a> SM-RT76 SM-RT70 SM-RT66 SM-RT64	<a href="#">SM-RT99</a> SM-RT99-A <a href="#">SM-RT81</a>
BR-U5000*3	Metal / Resin	Narrow	-	-	-	<a href="#">SM-RT99</a> SM-RT86 <a href="#">SM-RT81</a> SM-RT76 SM-RT70 SM-RT66 SM-RT64	<a href="#">SM-RT500</a> <a href="#">SM-RT99</a> SM-RT99-A <a href="#">SM-RT81</a>

\*1 Rotor for speed sensor SM-DUE11, rear only

\*2 Resin pad only

\*3 Not compatible with rear 180 mm (M) rotors

\*4 Not compatible with 220mm (LL) and 203 mm (L) rotors

\*5 For rear only. Not compatible with 220mm (LL), 203 mm (L) and 180 mm (M) rotors.

\*6 For rear only. Not compatible 220mm (LL) and with 203 mm (L) rotors.

\*7 Not compatible with 180 mm (M) rotors.

\*8 Not compatible with 140 mm (SS) rotors.

\*9 Please note that the brake kit consisting of BR-RS405, SM-BH59-JK-SSR, and either ST-U6030-R/ST-U6030-L/BL-U6030-L/[ST-R4020-R](#) or [ST-R4020-L](#) is not compatible with 140 mm (SS) rotors.

Wide type rotor

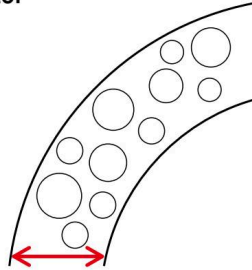

Narrow type rotor

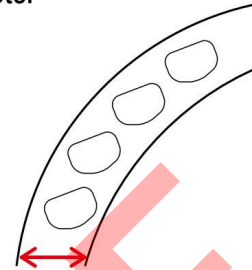

#### NOTE

- SM-RT56 / SM-RT54 / SM-RT30 / SM-RT26 / SM-RT10 / RT-EM300 / [RT-CL300](#) are compatible with Resin pad caliper specification only. If use with metal pads, rotor will be easily damaged.
- When using 140 mm rotor, braking power is less than 160 mm, please confirm the power is enough for your purpose. 140 mm rotor is recommended for rear use only.
- Narrow type 2 piece rotors are not compatible to brake caliper for Wide type rotor because of interference.
- BR-UR300 doesn't need front mount bracket and rear adapter.

# Compatibility of lock ring with hubs

C-612

## Front hub (Disc Brake)

Type	Fixing type of lock ring		
	Internal spline	both Internal & external spline	External spline
QR type	✓	✓	✓
12 mm E-THRU type	✓	✓*	✓
15 mm E-THRU type	-	✓*	✓
20 mm thru axle type	-	✓*	✓

\* For E-THRU hub, "Internal & external spline" type lock ring can not be install by TL-LR11. Please Tighten with TL-FC36.

## FREEHUB (Disc Brake)

Model No.	Fixing type of lock ring		
	Internal spline	Internal & external spline	External spline
<a href="#">FH-M9210-B</a>	✓	✓	✓
<a href="#">FH-M8210-B</a>	✓	✓	✓
FH-M9111 FH-M9111-B FH-M9111-BS FH-M9000 FH-M9010 FH-M9010-B FH-MT901-B FH-MT901-BS	-	-	✓
Other models (MTB, Trekking, ROAD, URBAN)	✓	✓	✓

# Compatibility between brake systems (MT400 series)

C-606

	BR-MT400	BR-MT410	BR-MT420
<a href="#">BL-MT400</a>	✓	✓	-
BL-MT402-3A	✓	✓	✓
<a href="#">BL-MT402-ABS</a>	-	-	✓
<a href="#">BL-MT401-3A</a>	✓	✓	-
BL-MT401	✓	✓	✓
BL-M4100	✓	✓	✓

# Combination chart (mechanical disc brake)

C-462

## Mechanical disc brake combination chart C-463

In order to realize the best performance, we recommend that the following combination be used.

Model No.	Mount type	Brake lever
BR-M375 BR-TX805	*	V-BRAKE BL (2 finger)
<a href="#">BR-R517</a>	*	Road lever**
BR-R317	*	Road lever**
<a href="#">BR-CX77</a>	*	Road lever**
BR-RS305	FLAT MOUNT	Road lever**

\* Front mount: International standard / Post mount, Rear mount: International standard / Post mount

\*\* For BL-R780 / 4600 / 5700

## Mechanical disc brake and brake lever compatibility C-464

Model No.	Brake lever type		
	2 finger	3,4 finger	3,4 finger w/ POWER MODULATOR* w/ SM-PM50
BR-M375	✓	-	✓
BR-TX805	✓	-	✓

\* POWER MODULATOR must be used for front brake

## MTB, Trekking, URBAN, LIFESTYLE C-732

Connection		SM-BH90-JK-SSR	SM-BH90-SBM	SM-BH90-SBLS	SM-BH90-SBS	SM-BH90-SB	SM-BH90-SS
Rigidity		Straight - Straight	Straight - Banjo	Straight - Banjo	Straight - Banjo	Straight - Banjo	Straight - Straight
Rigidity		High power	High power	High power	High power	High power	High power
BL-M9200	BR-M9200	-	-	-	-	-	✓
	BR-MT805	-	-	-	-	-	✓
BL-M9220	BR-M9220	-	✓	-	-	-	-
	BR-M9200	-	-	-	-	-	✓
	BR-MT805	-	-	-	-	-	✓
BL-M8200	BR-M8200	-	✓	-	-	-	-
	BR-M8220	-	✓	-	-	-	-
	BR-MT805	-	-	-	-	-	✓
BL-M9100	BR-M9100	-	-	-	-	✓	
BL-M9100	BR-M9110	-	-	-	-	✓	
BL-M9120	BR-M9120	-	✓	-	-	-	-
BL-M9000	BR-M9000	-	✓	-	-	-	-
BL-M9020	BR-M9020	-	✓	-	-	✓	-
BL-M820	BR-M820	-	-	✓	-	-	-
BL-M8100	BR-M8100	-	✓	-	-	-	-
BL-M8100	BR-M8110	-	-	-	-	-	✓
BL-M8100	BR-M8120	-	✓	-	-	-	-
BL-M8000	BR-M8000	-	✓	-	-	✓	-
BL-M8000	BR-M8020	-	-	✓	-	-	-
BL-T8100	BR-M8100	-	✓	-	-	-	-
BL-T8100	BR-M8120	-	✓	-	-	-	-
BL-M7100	BR-M7100	-	✓	-	-	-	-
BL-M7100	BR-M7110	-	-	-	-	-	✓
BL-M7100	BR-M7120	-	✓	-	-	-	-
BL-M7000	BR-M7000	-	✓	-	-	✓	-
BL-M6100	BR-M6100	-	-	-	-	-	✓
BL-M6100	BR-M6120	-	-	-	-	-	✓
BL-T675	BR-T675	-	-	-	-	-	✓
BL-M640	BR-M640	-	-	✓	✓	-	-
BL-M6000	BR-M6000	-	-	-	-	-	✓
BL-M4100	BR-MT410	-	-	-	-	-	-
BL-M4100	BR-MT420	-	-	-	-	-	✓
BL-T6000	BR-M6000	-	-	-	-	-	-
BL-S7000	BR-S7000	-	-	-	-	-	-

Level of compatibility

✓: Compatible

\*: Refer to manual of SM-BH80, SM-BH59 (brake hose 10 m coil) for assembling / disassembling banjo unit

-: Impossible to use

		SM-BH90-JK-SSR	SM-BH90-SBM	SM-BH90-SBLS	SM-BH90-SBS	SM-BH90-SB	SM-BH90-SS
Connection		Straight - Straight	Straight - Banjo	Straight - Banjo	Straight - Banjo	Straight - Banjo	Straight - Straight
Rigidity		High power	High power	High power	High power	High power	High power
BL-MT501	BR-MT520	-	-	-	-	-	✓
BL-MT501	BR-MT500	-	-	-	-	-	-
BL-MT500	BR-MT500	-	-	-	-	-	-
ST-M4050	BR-M4050	-	-	-	-	-	-
ST-M3050	BR-M3050	-	-	-	-	-	-
BL-T445	BR-M446	-	-	-	-	-	-
BL-MT400	BR-MT400	-	-	-	-	-	-
BL-MT401	BR-MT400	-	-	-	-	-	-
BL-MT401	BR-MT410	-	-	-	-	-	-
BL-MT401	BR-MT420	-	-	-	-	-	✓
BL-MT401-3A	BR-MT400	-	-	-	-	-	-
BL-MT402-3A	BR-MT400	-	-	-	-	-	-
BL-MT402-3A	BR-MT410	-	-	-	-	-	-
BL-MT402-3A	BR-MT420	-	-	-	-	-	✓
BL-MT402-ABS	BR-MT420	-	-	-	-	-	✓
BL-MT201	BR-MT200	-	-	-	-	-	-
BL-MT200	BR-MT200	-	-	-	-	-	-
BL-MT201	BR-UR300	-	-	-	-	-	-
BL-MT200	BR-UR300	-	-	-	-	-	-
BL-MT200-ABS	BR-MT200	-	-	-	-	-	-
BL-M365	BR-M365	-	-	-	-	-	-
BL-M315	BR-M315	-	-	-	-	-	-
ST-EF515	BR-MT200	-	-	-	-	-	-
ST-EF505	BR-M315	-	-	-	-	-	-
ST-EF505	BR-MT200	-	-	-	-	-	-
BL-S700	BR-S700	-	✓	-	-	✓	-
BL-U8000	BR-U8000	-	✓	-	-	-	-
BL-U8000	BR-U8010	-	-	-	-	-	✓
BL-U8000	BR-U8020	-	✓	-	-	-	-
BL-U5000	BR-U5000	-	-	-	-	-	-
BL-U5010		-	-	-	-	-	-
ST-U5060		-	-	-	-	-	-
BL-UR405	BR-MT410	-	-	-	-	-	-

Level of compatibility

✓: Compatible

\*: Refer to manual of SM-BH80, SM-BH59 (brake hose 10 m coil) for assembling / disassembling banjo unit

-: Impossible to use

		SM-BH59-J-SS	SM-BH59-JK-SS (MTB)	SM-BH59-JK-SS (ROAD)	SM-BH59-JK-SSR	SM-BH59-SB	SM-BH59-SB-J
Connection		Straight - Straight	Straight - Straight	Straight - Straight	Straight - Straight	Straight - Banjo	Straight - Banjo
Rigidity		Standard	Standard	Standard	Standard	Standard	Standard
BL-M9200	BR-M9200	-	-	-	-	-	-
	BR-MT805	-	-	-	-	-	-
BL-M9220	BR-M9220	-	-	-	-	-	-
	BR-M9200	-	-	-	-	-	-
	BR-MT805	-	-	-	-	-	-
BL-M8200	BR-M8200	-	-	-	-	-	-
	BR-M8220	-	-	-	-	-	-
	BR-MT805	-	-	-	-	-	-
BL-M9100	BR-M9100	-	-	-	-	-	
BL-M9100	BR-M9110	-	-	-	-	-	
BL-M9120	BR-M9120	-	-	-	-	-	
BL-M9000	BR-M9000	-	-	-	-	-	
BL-M9020	BR-M9020	-	-	-	-	-	
BL-M820	BR-M820	-	-	-	-	-	
BL-M8100	BR-M8100	-	-	-	-	-	
BL-M8100	BR-M8110	-	-	-	-	-	
BL-M8100	BR-M8120	-	-	-	-	-	
BL-M8000	BR-M8000	-	-	-	-	-	
BL-M8000	BR-M8020	-	-	-	-	-	
BL-T8100	BR-M8100	-	-	-	-	-	
BL-T8100	BR-M8120	-	-	-	-	-	
BL-M7100	BR-M7100	-	-	-	-	-	
BL-M7100	BR-M7110	-	-	-	-	-	
BL-M7100	BR-M7120	-	-	-	-	-	
BL-M7000	BR-M7000	-	-	-	-	-	
BL-M6100	BR-M6100	-	-	-	-	-	
BL-M6100	BR-M6120	-	-	-	-	-	
BL-T675	BR-T675	-	-	-	-	-	
BL-M640	BR-M640	-	-	-	-	-	
BL-M6000	BR-M6000	-	-	-	-	-	
BL-M4100	BR-MT410	-	✓	-	-	-	
BL-M4100	BR-MT420	-	-	-	-	-	
BL-T6000	BR-M6000	-	✓	-	-	-	
BL-S7000	BR-S7000	-	✓	-	-	-	

Level of compatibility

✓: Compatible

\*: Refer to manual of SM-BH80, SM-BH59 (brake hose 10 m coil) for assembling / disassembling banjo unit

-: Impossible to use

		SM-BH59-J-SS	SM-BH59-JK-SS (MTB)	SM-BH59-JK-SS (ROAD)	SM-BH59-JK-SSR	SM-BH59-SB	SM-BH59-SB-J
Connection		Straight - Straight	Straight - Straight	Straight - Straight	Straight - Straight	Straight - Banjo	Straight - Banjo
Rigidity		Standard	Standard	Standard	Standard	Standard	Standard
BL-MT501	BR-MT520	-	-	-	-	-	-
BL-MT501	BR-MT500	-	✓	-	-	-	-
BL-MT500	BR-MT500	-	✓	-	-	-	-
ST-M4050	BR-M4050	-	✓	-	-	-	-
ST-M3050	BR-M3050	-	✓	-	-	-	-
BL-T445	BR-M446	-	✓	-	-	-	-
BL-MT400	BR-MT400	-	✓	-	-	-	-
BL-MT401	BR-MT400	-	✓	-	-	-	-
BL-MT401	BR-MT410	-	✓	-	-	-	-
BL-MT401	BR-MT420	-	-	-	-	-	-
BL-MT401-3A	BR-MT400	-	✓	-	-	-	-
BL-MT402-3A	BR-MT400	-	✓	-	-	-	-
BL-MT402-3A	BR-MT410	-	✓	-	-	-	-
BL-MT402-3A	BR-MT420	-	-	-	-	-	-
BL-MT402-ABS	BR-MT420	-	-	-	-	-	-
BL-MT201	BR-MT200	-	✓	-	-	-	-
BL-MT200	BR-MT200	-	✓	-	-	-	-
BL-MT201	BR-UR300	-	✓	-	-	-	-
BL-MT200	BR-UR300	-	✓	-	-	-	-
BL-MT200-ABS	BR-MT200	-	✓	-	-	-	-
BL-M365	BR-M365	-	✓	-	-	-	-
BL-M315	BR-M315	-	✓	-	-	-	-
ST-EF515	BR-MT200	-	✓	-	-	-	-
ST-EF505	BR-M315	-	✓	-	-	-	-
ST-EF505	BR-MT200	-	✓	-	-	-	-
BL-S700	BR-S700	-	-	-	-	-	-
BL-U8000	BR-U8000	-	-	-	-	-	-
BL-U8000	BR-U8010	-	-	-	-	-	-
BL-U8000	BR-U8020	-	-	-	-	-	-
BL-U5000		-	-	✓	-	-	-
BL-U5010	BR-U5000	-	-	✓	-	-	-
ST-U5060		-	-	✓	-	-	-
BL-UR405	BR-MT410	-	✓	-	-	-	-

Level of compatibility

✓: Compatible

\*: Refer to manual of SM-BH80, SM-BH59 (brake hose 10 m coil) for assembling / disassembling banjo unit

-: Impossible to use

# ROAD, Gravel, LIFESTYLE C-733

Connection		SM-BH90-JK-SSR	SM-BH90-SBM	SM-BH90-SBLS	SM-BH90-SBS	SM-BH90-SB	SM-BH90-SS
Rigidity		Straight - Straight	Straight - Banjo	Straight - Banjo	Straight - Banjo	Straight - Banjo	Straight - Straight
		High power	High power	High power	High power	High power	High power
ST-R9270	BR-R9270	✓	-	-	-	-	-
ST-R9120	BR-R9170	✓	-	-	-	-	-
ST-R9170	BR-R9170	✓	-	-	-	-	-
ST-R9180	BR-R9170	✓	-	-	-	-	-
ST-R8170	BR-R8170	✓	-	-	-	-	-
ST-R8020	BR-R8070	✓	-	-	-	-	-
ST-R8070	BR-R8070	✓	-	-	-	-	-
ST-R7120	BR-R7170	✓	-	-	-	-	-
ST-R7170	BR-R7170	✓	-	-	-	-	-
BL-RS717	BR-R9270	✓	-	-	-	-	-
BL-RS717	BR-R8170	✓	-	-	-	-	-
BL-RS717	BR-R7170	✓	-	-	-	-	-
BL-RS717	BR-RX410	✓	-	-	-	-	-
ST-R7020	BR-R7170	✓	-	-	-	-	-
ST-R7020	BR-R7070	✓	-	-	-	-	-
ST-R7025	BR-R7170	✓	-	-	-	-	-
ST-R7025	BR-R7070	✓	-	-	-	-	-
ST-R785	BR-RS805	-	-	-	-	-	-
ST-R785	BR-RS785	-	-	-	-	-	-
ST-R785	BR-R785	-	-	-	-	-	-
ST-RS685	BR-RS805	-	-	-	-	-	-
ST-RS685	BR-RS785	-	-	-	-	-	-
ST-RS685	BR-R785	-	-	-	-	-	-
ST-RS505	BR-RS785	-	-	-	-	-	-
ST-RS505	BR-RS505	-	-	-	-	-	-
ST-R4020	BR-RS405	-	-	-	-	-	-
ST-RS405	BR-RS405	-	-	-	-	-	-
BL-RS600	BR-RS405	-	-	-	-	-	-
ST-RX820	BR-RX820	✓	-	-	-	-	-
ST-RX825	BR-RX820	✓	-	-	-	-	-
ST-RX815	BR-RX820	✓	-	-	-	-	-
ST-RX815	BR-RX810	✓	-	-	-	-	-
ST-RX810-LE	BR-RX820-LE	✓	-	-	-	-	-
BL-T8100-LE	BR-RX820-LE	-	-	-	-	-	✓
BL-RX825	BR-RX820	✓	-	-	-	-	-
ST-RX810	BR-RX820	✓	-	-	-	-	-
ST-RX810	BR-RX810	✓	-	-	-	-	-
BL-RX820	BR-RX820	✓	-	-	-	-	-
BL-RX810	BR-RX820	✓	-	-	-	-	-
BL-RX810	BR-RX810	✓	-	-	-	-	-
ST-RX715-R	BR-RX410	✓	-	-	-	-	-
ST-RX610	BR-RX410	✓	-	-	-	-	-
ST-RX610	BR-RX400	✓	-	-	-	-	-
ST-RX600	BR-RX410	✓	-	-	-	-	-
ST-RX600	BR-RX400	✓	-	-	-	-	-
BL-RX610	BR-RX410	✓	-	-	-	-	-
BL-RX610	BR-RX400	✓	-	-	-	-	-
BL-RX600	BR-RX410	✓	-	-	-	-	-
BL-RX600	BR-RX400	✓	-	-	-	-	-
ST-RX400	BR-RX410	✓	-	-	-	-	-
ST-RX400	BR-RX400	✓	-	-	-	-	-
ST-U6030	BR-U6030	-	-	-	-	-	-
BL-U6030-L	BR-U6030	-	-	-	-	-	-
ST-U6030	BR-RS405	-	-	-	-	-	-
BL-U6030-L	BR-RS405	-	-	-	-	-	-

Level of compatibility

✓: Compatible

\*: Refer to manual of SM-BH80, SM-BH59 (brake hose 10 m coil) for assembling / disassembling banjo unit

-: Impossible to use

		SM-BH59-J-SS	SM-BH59-JK-SS (MTB)	SM-BH59-JK-SS (ROAD)	SM-BH59-JK-SSR	SM-BH59-SB	SM-BH59-SB-J
Connection		Straight - Straight	Straight - Straight	Straight - Straight	Straight - Straight	Straight - Banjo	Straight - Banjo
Rigidity		Standard	Standard	Standard	Standard	Standard	Standard
ST-R9270	BR-R9270	-	-	-	-	-	-
ST-R9120	BR-R9170	-	-	-	-	-	-
ST-R9170		-	-	-	-	-	-
ST-R9180	BR-R9170	-	-	-	-	-	-
ST-R8170	BR-R8170	-	-	-	-	-	-
ST-R8020	BR-R8070	-	-	-	-	-	-
ST-R8070		-	-	-	-	-	-
ST-R7120	BR-R7170	-	-	-	-	-	-
ST-R7170	BR-R7170	-	-	-	-	-	-
<a href="#">BL-RS717</a>	BR-R9270	-	-	-	-	-	-
<a href="#">BL-RS717</a>	BR-R8170	-	-	-	-	-	-
<a href="#">BL-RS717</a>	BR-R7170	-	-	-	-	-	-
<a href="#">BL-RS717</a>	BR-RX410	-	-	-	-	-	-
ST-R7020	BR-R7170	-	-	-	-	-	-
ST-R7020	BR-R7070	-	-	-	-	-	-
ST-R7025	BR-R7170	-	-	-	-	-	-
ST-R7025	BR-R7070	-	-	-	-	-	-
<a href="#">ST-R785</a>	<a href="#">BR-RS805</a>	✓	-	-	-	-	-
<a href="#">ST-R785</a>	BR-RS785	✓	-	-	-	-	-
<a href="#">ST-R785</a>	<a href="#">BR-R785</a>	-	-	-	-	✓	✓
ST-RS685	<a href="#">BR-RS805</a>	✓	-	✓	-	-	-
ST-RS685	BR-RS785	✓	-	✓	-	-	-
ST-RS685	<a href="#">BR-R785</a>	-	-	-	-	✓	✓
<a href="#">ST-RS505</a>	BR-RS785	✓	-	✓	-	-	-
<a href="#">ST-RS505</a>	<a href="#">BR-RS505</a>	✓	-	✓	-	-	-
<a href="#">ST-R4020</a>	BR-RS405	-	-	-	✓	-	-
ST-RS405	BR-RS405	-	-	✓	-	-	-
BL-RS600	BR-RS405	-	✓	-	-	-	-
ST-RX820	BR-RX820	-	-	-	-	-	-
ST-RX825	BR-RX820	-	-	-	-	-	-
ST-RX815	BR-RX820	-	-	-	-	-	-
ST-RX815	BR-RX810	-	-	-	-	-	-
ST-RX810-LE	BR-RX820-LE	-	-	-	-	-	-
BL-T8100-LE	BR-RX820-LE	-	-	-	-	-	-
<a href="#">BL-RX825</a>	BR-RX820	-	-	-	-	-	-
ST-RX810	BR-RX820	-	-	-	-	-	-
ST-RX810	BR-RX810	-	-	-	-	-	-
BL-RX820	BR-RX820	-	-	-	-	-	-
BL-RX810	BR-RX820	-	-	-	-	-	-
BL-RX810	BR-RX810	-	-	-	-	-	-
<a href="#">ST-RX715-R</a>	BR-RX410	-	-	-	-	-	-
ST-RX610	BR-RX410	-	-	-	-	-	-
ST-RX610	BR-RX400	-	-	-	-	-	-
ST-RX600	BR-RX410	-	-	-	-	-	-
ST-RX600	BR-RX400	-	-	-	-	-	-
BL-RX610	BR-RX410	-	-	-	-	-	-
BL-RX610	BR-RX400	-	-	-	-	-	-
BL-RX600	<a href="#">BR-RX410</a>	-	-	-	-	-	-
BL-RX600	<a href="#">BR-RX400</a>	-	-	-	-	-	-
BL-RX600	BR-RX410	-	-	-	-	-	-
ST-RX400	BR-RX400	-	-	-	-	-	-
ST-U6030	BR-U6030	-	-	-	✓	-	-
BL-U6030-L		-	-	-	-	✓	-
ST-U6030	BR-RS405	-	-	-	✓	-	-
BL-U6030-L		-	-	-	-	✓	-

Level of compatibility

✓: Compatible



\*: Refer to manual of SM-BH80, SM-BH59 (brake hose 10 m coil) for assembling / disassembling banjo unit

-: Impossible to use

Banjo screw	Special	Normal	Short	BR-M9120 SPEC.	BR-M8100 SPEC.
<a href="#">BR-M9220</a>	-	-	-	-	✓
BR-M9120	-	-	-	✓	-
<a href="#">BR-M9000</a>	✓	-	-	-	-
<a href="#">BR-M9020</a>	✓	✓	-	-	-
BR-M820	-	-	✓	-	✓
<a href="#">BR-M8200</a>	-	-	-	-	✓
<a href="#">BR-M8220</a>	-	-	-	-	✓
BR-M8100	-	-	-	-	✓
BR-M8120	-	-	-	✓	-
BR-M8000	✓	✓	-	-	-
BR-M8020	-	-	✓	-	-
BR-M7100	-	-	-	-	✓
BR-M7120	-	-	-	✓	-
<a href="#">BR-M7000</a>	✓	✓	-	-	-
<a href="#">BR-M640</a>	-	-	✓	-	✓
<a href="#">BR-S700</a>	✓	✓	-	-	-
<a href="#">BR-R785</a>	✓	✓	-	-	-
BR-U8000	-	-	-	-	✓
BR-U8020	-	-	-	✓	-

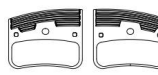

## Brake pad line-up

### Brake pad for hydraulic disc brake (4-piston) C-652

Pad Shape Type									
		D-type		H-type		N-type		P-type	
Model No.		Narrow type		Narrow type		Narrow type		Narrow type	
		BP-D03S-RX Resin	BP-D02S-MX Metal	BP-H03A-RF Resin	BP-H03C-MF Metal	BP-N03A-RF Resin	BP-N04C-MF Metal	BP-P03A-RF Resin	BP-P04C-MF Metal
Characteristics	Modulation	★★★★★	★★★★☆	★★★★★	★★★★☆	★★★★★	★★★★☆	★★★★★	★★★★☆
	Power	★★★★☆	★★★★★	★★★★☆	★★★★★	★★★★☆	★★★★★	★★★★☆	★★★★★
	Durability	★★★★★	★★★★★	★★★★★	★★★★★	★★★★★	★★★★★	★★★★★	★★★★★
	Anti-fading	★★★★☆	★★★★★	★★★★☆	★★★★★	★★★★★	★★★★★	★★★★★	★★★★★
	Silence	★★★★★	★★★★☆	★★★★★	★★★★☆	★★★★★	★★★★☆	★★★★★	★★★★☆
Pad Radiator fin		-	-	✓	✓	✓	✓	✓	✓
High heat insulation		-	-	-	-	-	-	-	-
Pad Back plate	Titanium	-	-	-	-	-	-	-	-
	Aluminum	-	-	✓	-	✓	-	✓	-
	Stainless steel/ Aluminum	-	-	-	✓	-	✓	-	✓
	Stainless steel	✓	✓	-	-	-	-	-	-
<a href="#">BR-M9220</a>	Hydraulic	Option	Option	-	-	Option	Option	Standard *	Standard *
<a href="#">BR-M8220</a>	Hydraulic	Option	Option	-	-	Option	Option	Standard *	Standard *
BR-M9120	Hydraulic	Option	Option	-	-	Standard	Standard	Option	Option
BR-M8120	Hydraulic	Option	Option	-	-	Standard	Standard	Option	Option
BR-M7120	Hydraulic	Standard	Option	-	-	Standard	Option	Option	Option
BR-M6120	Hydraulic	Standard	Option	-	-	-	-	-	-
BR-MT520	Hydraulic	Standard	Standard	-	-	-	-	-	-
BR-MT420	Hydraulic	Standard	Standard	-	-	-	-	-	-
BR-M8020	Hydraulic	Option	-	Standard	Option	-	-	-	-
BR-M820	Hydraulic	-	-	Standard	Standard	-	-	-	-
BR-U8020	Hydraulic	Standard	Option	-	-	Standard	Option	Option	Option

\* Reduced rattling noise



# Brake pad for hydraulic disc brake (2-piston) and mechanical disc brake C-653

Pad Shape Type									
		B-type		G-type					
		Wide type		Narrow type					
Model No.		BP-B03S-RX	BP-B05S-RX	BP-G03A-RX	BP-G05A-RX	BP-G03S-RX	BP-G05S-RX	BP-G04S-MX	BP-G04Ti-MX
		Resin	Resin	Resin	Resin	Resin	Resin	Metal	Metal
Characteristics	Modulation	★★★★★	★★★★★	★★★★★	★★★★★	★★★★★	★★★★★	★★★★☆	★★★★☆
	Power	★★★★☆	★★★★☆	★★★★☆	★★★★☆	★★★★☆	★★★★☆	★★★★★	★★★★★
	Durability	★★★★★	★★★★★ *1	★★★★★	★★★★★ *1	★★★★★	★★★★★ *1	★★★★★	★★★★★
	Anti-fading	★★★★☆	★★★★☆	★★★★☆	★★★★☆	★★★★☆	★★★★☆	★★★★★	★★★★★
	Silence	★★★★★	★★★★★	★★★★★	★★★★★	★★★★★	★★★★★	★★★★☆	★★★★☆
Pad Radiator fin		-	-	-	-	-	-	-	-
High heat insulation		-	-	✓	✓	✓	✓	-	-
Pad Back plate	Titanium	-	-	-	-	-	-	-	✓
	Aluminum	-	-	✓	✓	-	-	-	-
	Stainless steel/ Aluminum	-	-	-	-	-	-	-	-
	Stainless steel	✓	✓	-	-	✓	✓	✓	-
<a href="#">BR-M9200</a>	Hydraulic	-	-	-	-	-	-	-	-
<a href="#">BR-M8200</a>	Hydraulic	-	-	-	Standard	-	-	Standard	-
BR-M9100	Hydraulic	-	-	-	-	-	-	-	-
BR-M9110	Hydraulic	-	-	-	-	-	-	-	-
BR-M8100	Hydraulic	-	-	Standard	Standard	-	-	Standard	-
BR-M8110	Hydraulic	-	-	-	-	-	-	-	-
BR-M7100	Hydraulic	-	-	-	-	Standard	Standard	Standard	-
BR-M7110	Hydraulic	-	-	-	-	-	-	-	-
BR-M8000	Hydraulic	-	-	Standard	Standard	-	-	Option	-
BR-M6100	Hydraulic	-	-	-	-	Standard	Standard	Option	-
BR-M6000	Hydraulic	-	-	Standard	Standard	-	-	Option	-
<a href="#">BR-MT805</a>	Hydraulic	-	-	-	-	-	-	-	-
BR-MT500	Hydraulic	Standard	Standard	-	-	-	-	-	-
<a href="#">BR-MT400</a>	Hydraulic	Standard	Standard	-	-	-	-	-	-
BR-MT410	Hydraulic	Standard	Standard	-	-	-	-	-	-
BR-MT200	Hydraulic	Standard	Standard	-	-	-	-	-	-
BR-M375	Mechanical	Standard	Standard	-	-	-	-	-	-
BR-TX805	Mechanical	Standard	Standard	-	-	-	-	-	-
BR-R9270	Hydraulic	-	-	-	-	-	-	-	-
BR-R9170	Hydraulic	-	-	-	-	-	-	-	-
BR-R8170	Hydraulic	-	-	-	-	-	-	-	-
BR-R8070	Hydraulic	-	-	-	-	-	-	-	-
BR-R7170	Hydraulic	-	-	-	-	-	-	-	-
BR-R7070	Hydraulic	-	-	-	-	-	-	-	-
BR-4770	Hydraulic	-	-	-	-	-	-	-	-
BR-RS785	Hydraulic	-	-	Option	Option	-	-	-	-
BR-RS405	Hydraulic	-	-	-	-	-	-	-	-
BR-RX820	Hydraulic	-	-	-	-	-	-	-	-
BR-RX820-LE	Hydraulic	-	-	-	-	-	-	-	-
BR-RX810	Hydraulic	-	-	-	-	-	-	-	-
BR-RX410	Hydraulic	-	-	-	-	-	-	-	-
BR-RX400	Hydraulic	-	-	-	-	-	-	-	-
BR-UR300	Hydraulic	Standard	Standard	-	-	-	-	-	-
BR-S7000	Hydraulic	-	-	-	-	Standard	Standard	-	-
BR-RS305	Mechanical	-	-	-	-	-	-	-	-
BR-R317	Mechanical	-	-	Standard	Standard	-	-	-	-
BR-U8000	Hydraulic	-	-	Standard	Standard	-	-	Option	-
BR-U8010	Hydraulic	-	-	-	-	-	-	-	-
BR-U6030	Hydraulic	-	Standard	-	-	-	-	-	-

\*1 "05" pad is more durable than "03" pad in the same type by 40%

Pad Shape Type							
		K-type					
		Narrow type					
Model No.		BP-K03S-RX	BP-K05S-RX	BP-K03Ti-RX	BP-K05Ti-RX	BP-K04S-MX	BP-K04Ti-MX
		Resin	Resin	Resin	Resin	Metal	Metal
Characteristics	Modulation	★★★★★	★★★★★	★★★★★	★★★★★	★★★★☆	★★★★☆
	Power	★★★★☆	★★★★☆	★★★★☆	★★★★☆	★★★★★	★★★★★
	Durability	★★★★★	★★★★★*1	★★★★★	★★★★★*1	★★★★★	★★★★★
	Anti-fading	★★★★☆	★★★★☆	★★★★☆	★★★★☆	★★★★★	★★★★★
	Silence	★★★★★	★★★★★	★★★★★	★★★★★	★★★★☆	★★★★☆
Pad Radiator fin		-	-	-	-	-	-
High heat insulation		✓	✓	✓	✓	-	-
Pad Back plate	Titanium	-	-	✓	✓	-	✓
	Aluminum	-	-	-	-	-	-
	Stainless steel/ Aluminum	-	-	-	-	-	-
	Stainless steel	✓	✓	-	-	✓	-
<a href="#">BR-M9200</a>	Hydraulic	-	-	-	Standard	-	Standard
<a href="#">BR-M8200</a>	Hydraulic	-	-	-	-	-	-
BR-M9100	Hydraulic	-	-	Standard	Standard	-	Standard
BR-M9110	Hydraulic	-	-	Standard	Standard	-	Standard
BR-M8100	Hydraulic	-	-	-	-	-	-
BR-M8110	Hydraulic	Standard	Standard	-	-	Standard	-
BR-M7100	Hydraulic	-	-	-	-	-	-
BR-M7110	Hydraulic	Standard	Standard	-	-	Standard	-
BR-M8000	Hydraulic	-	-	-	-	-	-
BR-M6100	Hydraulic	-	-	-	-	-	-
BR-M6000	Hydraulic	-	-	-	-	-	-
<a href="#">BR-MT805</a>	Hydraulic	-	Standard	-	-	Standard	-
BR-MT500	Hydraulic	-	-	-	-	-	-
<a href="#">BR-MT400</a>	Hydraulic	-	-	-	-	-	-
BR-MT410	Hydraulic	-	-	-	-	-	-
BR-MT200	Hydraulic	-	-	-	-	-	-
BR-M375	Mechanical	-	-	-	-	-	-
BR-TX805	Mechanical	-	-	-	-	-	-
BR-R9270	Hydraulic	-	-	Standard	Standard	-	Option
BR-R9170	Hydraulic	-	-	Standard	Standard	-	Option
BR-R8170	Hydraulic	Standard	Standard	-	-	-	-
BR-R8070	Hydraulic	Standard	Standard	-	-	Option	-
BR-R7170	Hydraulic	Standard	Standard	-	-	-	-
BR-R7070	Hydraulic	Standard	Standard	-	-	Option	-
BR-4770	Hydraulic	Standard	Standard	-	-	Standard	-
BR-RS785	Hydraulic	-	-	-	-	-	-
BR-RS405	Hydraulic	Standard	Standard	-	-	-	-
BR-RX820	Hydraulic	Standard	Standard	-	-	-	-
BR-RX820-LE	Hydraulic	Standard	Standard	-	-	-	-
BR-RX810	Hydraulic	Standard	Standard	-	-	Option	-
BR-RX410	Hydraulic	-	Standard	-	-	-	-
BR-RX400	Hydraulic	Standard	Standard	-	-	Option	-
BR-UR300	Hydraulic	-	-	-	-	-	-
BR-S7000	Hydraulic	-	-	-	-	-	-
BR-RS305	Mechanical	Standard	Standard	-	-	-	-
BR-R317	Mechanical	-	-	-	-	-	-
BR-U8000	Hydraulic	-	-	-	-	-	-
BR-U8010	Hydraulic	-	Standard	-	-	-	-
BR-U6030	Hydraulic	-	-	-	-	-	-

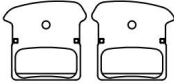
\*1 "05" pad is more durable than "03" pad in the same type by 40%

Pad Shape Type							
		J-type			L-type		
Model No.		Narrow type			Narrow type		
		BP-J03A-RF Resin	BP-J05A-RF Resin	BP-J04C-MF Metal	BP-L03A-RF Resin	BP-L05A-RF Resin	BP-L04C-MF Metal
Characteristics	Modulation	★★★★★	★★★★★	★★★★☆	★★★★★	★★★★★	★★★★☆
	Power	★★★★☆	★★★★★	★★★★★	★★★★☆	★★★★☆	★★★★★
	Durability	★★★★★	★★★★★*1	★★★★★	★★★★★	★★★★★*1	★★★★★
	Anti-fading	★★★★☆	★★★★☆	★★★★★	★★★★☆	★★★★☆	★★★★★
	Silence	★★★★★	★★★★★	★★★★☆	★★★★★	★★★★★	★★★★☆
Pad Radiator fin		✓	✓	✓	✓	✓	✓
High heat insulation		✓	✓	-	✓	✓	-
Pad Back plate	Titanium	-	-	-	-	-	-
	Aluminum	✓	✓	-	✓	✓	-
	Stainless steel/ Aluminum	-	-	✓	-	-	✓
	Stainless steel	-	-	-	-	-	-
<a href="#">BR-M920Q</a>	Hydraulic	-	-	-	-	-	-
<a href="#">BR-M820Q</a>	Hydraulic	-	Option	Option	-	-	-
BR-M9100	Hydraulic	-	-	-	-	-	-
BR-M9110	Hydraulic	-	-	-	-	-	-
BR-M8100	Hydraulic	Option	Option	Option	-	-	-
BR-M8110	Hydraulic	-	-	-	Option	Option	Option
BR-M7100	Hydraulic	Option	Option	Option	-	-	-
BR-M7110	Hydraulic	-	-	-	Option	Option	Option
BR-M8000	Hydraulic	Standard	Standard	Option	-	-	-
BR-M6100	Hydraulic	Standard	Standard	-	-	-	-
BR-M6000	Hydraulic	Standard	Standard	-	-	-	-
<a href="#">BR-MT805</a>	Hydraulic	-	-	-	-	Option	Option
BR-MT500	Hydraulic	-	-	-	-	-	-
<a href="#">BR-MT400</a>	Hydraulic	-	-	-	-	-	-
BR-MT410	Hydraulic	-	-	-	-	-	-
BR-MT200	Hydraulic	-	-	-	-	-	-
BR-M375	Mechanical	-	-	-	-	-	-
BR-TX805	Mechanical	-	-	-	-	-	-
BR-R9270	Hydraulic	-	-	-	Standard	Standard	Option
BR-R9170	Hydraulic	-	-	-	Standard	Standard	Option
BR-R8170	Hydraulic	-	-	-	Standard	Standard	Option
BR-R8070	Hydraulic	-	-	-	Standard	Standard	Option
BR-R7170	Hydraulic	-	-	-	Standard	Standard	Option
BR-R7070	Hydraulic	-	-	-	Standard	Standard	Option
BR-4770	Hydraulic	-	-	-	Option	Option	-
BR-RS785	Hydraulic	Standard	Standard	Standard	-	-	-
BR-RS405	Hydraulic	-	-	-	Option	Option	-
BR-RX820	Hydraulic	-	-	-	Standard	Standard	Option
BR-RX820-LE	Hydraulic	-	-	-	Standard	Standard	Option
BR-RX810	Hydraulic	-	-	-	Standard	Standard	Option
BR-RX410	Hydraulic	-	-	-	-	Standard	Option
BR-RX400	Hydraulic	-	-	-	Standard	Standard	Option
BR-UR300	Hydraulic	-	-	-	-	-	-
BR-S7000	Hydraulic	-	-	-	-	-	-
BR-RS305	Mechanical	-	-	-	Option	Option	-
BR-R317	Mechanical	-	-	-	-	-	-
BR-U8000	Hydraulic	Option	Option	-	-	-	-
BR-U8010	Hydraulic	-	-	-	-	Standard	-
BR-U6030	Hydraulic	-	-	-	-	-	-

\*1 "05" pad is more durable than "03" pad in the same type by 40%

## How to read Model No. C-194

(1)
(2)
(3)
(4)
(5)
(6)  
**S** - **M** - **A** - **F** **203** **S** / **P**

(1)	Small parts
(2)	Mount adapter
(3)	F = Front and Rear * R = Rear
(4)	Rotor size **
(5)	Caliper mount type S = International A-standard P = Post D = Flat mount
(6)	Suspension / Frame type S = International A-standard P = Post D = Flat mount

### NOTE

\* This part may be used in the rear.

In this case, the rotor size description is also different. Refer to [C-195](#).

\*\* Rotor size descriptions are for the 160 mm direct post mount and International A standard forks and frames. Refer to [C-195](#) for other mount types.

ARCHIVE

## Application table for adapter C-195

### For post mount brake caliper

Fork and frame mount type			Rotor size				
			140 mm (SS)	160 mm (S)	180 mm (M)	203 mm (L)	220 mm (LL)
Post mount	Front	140 mm direct	Direct mount	SM-MA90-F180P/P SM-MA-F180P/P2 (for R785)	-	-	-
		160 mm direct	-	Direct mount	SM-MA90-F180P/P SM-MA-F180P/P2	SM-MA-F203P/P	-
		180 mm direct	-	-	Direct mount	SM-MA90-F203P/PM SM-MA-F203P/PM	SM-MA-F220P/PM
		200 mm direct	-	-	-	SM-MA-F203P/PL2	SM-MA-F220P/PL2
		203 mm direct	-	-	-	Direct mount	SM-MA-F220P/PL
	Rear	140 mm direct	Direct mount	SM-MA90-F180P/P SM-MA-F180P/P2	-	-	-
		160 mm direct	-	Direct mount	SM-MA90-F180P/P SM-MA-F180P/P2	SM-MA-F203P/P	-
		180 mm direct	-	-	Direct mount	SM-MA90-F203P/PM SM-MA-F203P/PM	SM-MA-F220P/PM
		200 mm direct	-	-	-	SM-MA-F203P/PL2	SM-MA-F220P/PL2
		203 mm direct	-	-	-	Direct mount	SM-MA-F220P/PL
International A-standard	Front	-	SM-MA90-F160P/S SM-MA-F160P/S	SM-MA-F180P/S	SM-MA-F203P/S	-	
	Rear	SM-MA90-R140P/S	SM-MA90-R160P/S SM-MA-R160P/S	SM-MA90-R180P/S SM-MA-R180P/S	SM-MA-R203P/S	-	
Flat mount ø140/160	Front	SM-MA-F140P/D	SM-MA-F160P/D	-	-	-	
	Rear	SM-MA-R140P/D	SM-MA-R160P/D	-	-	-	
Flat mount ø160/180	Front	-	-	-	-	-	
	Rear	-	-	-	-	-	





### For flat mount brake caliper



Fork and frame mount type			Rotor size		
			140 mm (SS)	160 mm (S)	180 mm (M)
Flat mount	ø140/160	Front	With Y8N230000* on product	With Y8N230000* on product	-
		Rear	Direct mount	SM-MA-R160D/D	-
	ø160/180	Front	-	With Y8N230000* on product	With Y8N230000* on product
		Rear	-	Direct mount	SM-MA-R160D/D
Flat mount BR-UR300	ø140/160	Front	-	Direct mount	-
		Rear	-	Direct mount	-
	ø160/180	Front	-	-	Direct mount
		Rear	-	-	Direct mount

\* SHIMANO easy flip-flop bracket system which allow 1 bracket to be compatible with 2 rotor size.

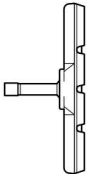
## Brake / Shoe line-up

C-201

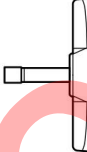
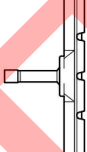
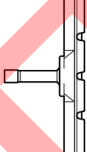
Model No.	M70R2	M70R2 (Severe Condition Shoes)	M70T3	M70T4	M70CT4 (Severe Condition Shoes)	
Brake shoe shape						
Cartridge type	✓	✓	-	-	✓	
Recommended rim	Aluminum	Aluminum	Alumite only	Aluminum	Aluminum	
Characteristics	DRY Power	★★★★★	★★★★★	★★★★☆	★★★★☆	
	WET Power	★★★★☆	★★★★☆	★★★★★	★★★★☆	
	Silence	★★★★☆	★★★★☆	★★★★★	★★★★☆	
	Anti-fading	★★★★☆	★★★★☆	★★★☆☆	★★★★☆	
	Durability (on road)	★★★★★	★★★★★	★★★☆☆	★★★★☆	
	Durability (muddy condition)	★★★★☆	★★★★☆	★★★☆☆	★★★★☆	
	Anti-rim attack	★★★★☆	★★★★☆	★★★☆☆	★★★☆☆	
	BR-T610	-	-	-	Option	Standard
	BR-T4000	-	-	-	-	-
	BR-MX70	-	-	Option	Option	-
BR-R353	-	-	-	Option	-	

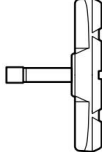
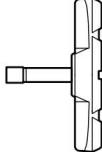
Model No.	M65T3	M65T4	S70C	S70C (Severe Condition Shoes)	S70T	S65T	
Brake shoe shape							
Cartridge type	-	-	✓	✓	-	-	
Recommended rim	Alumite only	Aluminum	Aluminum	Aluminum	Aluminum	Aluminum	
Characteristics	DRY Power	★★★★☆	★★★★★	★★★★★	★★★★☆	★★★★★	
	WET Power	★★★★★	★★★★☆	★★★★☆	★★★★☆	★★★★☆	
	Silence	★★★★★	★★★★☆	★★★★☆	★★★★☆	★★★★☆	
	Anti-fading	★★★☆☆	★★★★☆	★★★★★	★★★★★	★★★★★	
	Durability (on road)	★★★★☆	★★★★★	★★★★★	★★★★☆	★★★★☆	
	Durability (muddy condition)	★★★★☆	★★★★☆	★★★★☆	★★★★☆	★★★★☆	
	Anti-rim attack	★★★☆☆	★★★★☆	★★★★★	★★★★★	★★★★★	
	BR-T610	-	-	Standard	-	Option	-
	BR-T4000	Option	Option	-	-	-	Standard
	BR-MX70	-	-	Standard	-	-	-
BR-R353	-	-	-	-	Standard	-	

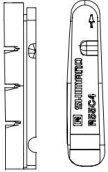
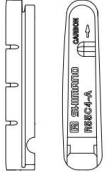
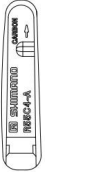
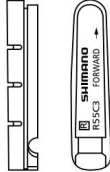
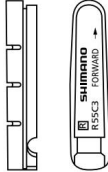
Model No.	R55C4	R55C4 FOR CARBON RIM	R55C4-A FOR CARBON RIM	R55C2	R55C3
Brake shoe shape					
Cartridge type	✓	✓	✓	✓	✓
Recommended rim	Aluminum	Carbon	Carbon	Aluminum	Aluminum
Characteristics	DRY Power	★★★★★	★★★★☆	★★★★★	★★★★★
	WET Power	★★★☆☆	★★★★☆	★★★★☆	★★★★☆
	Silence	★★★★☆	★★★★☆	★★★★☆	★★★★☆
	Anti-fading	★★★★★	★★★★★	★★★★★	★★★★★
	Durability (on road)	★★★★★	★★★★★	★★★★☆	★★★★★
	Durability (muddy condition)	★★★★★	★★★★★	★★★★☆	★★★★★
	Anti-rim attack	★★★★☆	★★★★☆	★★★★☆	★★★★★
	BR-R9200	Standard	Option	Option	-
	BR-R9210	Standard	Option	Option	-
	BR-R9100	Standard	Option	Option	-
	BR-R9110	Standard	Option	Option	-
	BR-R8100	Standard	Option	Option	-
	BR-R8110	Standard	Option	Option	-
	BR-RS811-R	Standard	Option	Option	-
	BR-R8000	Standard	Option	Option	-
	BR-R8010	Standard	Option	Option	-
	BR-R7000	Standard	Option	Option	-
	BR-R7010	Standard	Option	Option	-
	BR-4700	-	-	-	-
	BR-R3000	-	-	-	-
BR-R2000	-	-	-	-	
BR-CX50	-	-	-	-	
BR-R561	-	-	-	-	Standard
BR-R451	-	-	-	-	-

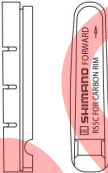
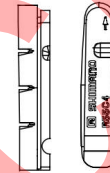
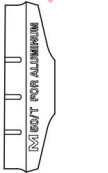
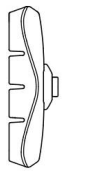
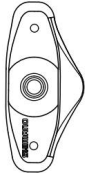
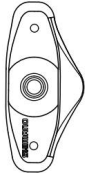
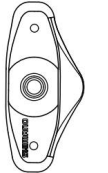
Model No.	R55C+1	R55CT4	M50T	R50T	R50T2	R50T4	R50T5	
Brake shoe shape								
Cartridge type	✓	✓	-	-	-	-	-	
Recommended rim	Aluminum	Aluminum	Aluminum	Aluminum	Aluminum	Aluminum	Aluminum	
Characteristics	DRY Power	★★★★☆	★★★★☆	★★★★☆	★★★★☆	★★★★☆	★★★★☆	
	WET Power	★★★☆☆	★★★★☆	★★★★☆	★★★★☆	★★★★☆	★★★★☆	
	Silence	★★★★☆	★★★★☆	★★★★☆	★★★★☆	★★★★☆	★★★★☆	
	Anti-fading	★★★★★	★★★★☆	★★★★☆	★★★★★	★★★★★	★★★★★	
	Durability (on road)	★★★★☆	★★★★☆	★★★★☆	★★★★☆	★★★★☆	★★★★☆	
	Durability (muddy condition)	★★★★☆	★★★★☆	★★★★☆	★★★★☆	★★★★☆	★★★★☆	
	Anti-rim attack	★★★★★	★★★★☆	★★★★☆	★★★★★	★★★★★	★★★★★	
	BR-R9200	-	Option	-	-	-	-	
	BR-R9210	-	Option	-	-	-	-	
	BR-R9100	-	Option	-	-	-	-	
	BR-R9110	-	Option	-	-	-	-	
	BR-R8100	-	Option	-	-	-	-	
	BR-R8110	-	Option	-	-	-	-	
	BR-RS811-R	-	Option	-	-	-	-	
	BR-R8000	-	Option	-	-	-	-	
	BR-R8010	-	Option	-	-	-	-	
	BR-R7000	-	Option	-	-	-	-	
	BR-R7010	-	Option	-	-	-	-	
	BR-4700	-	-	-	-	-	Option	Standard
	BR-R3000	-	-	-	-	-	Option	Standard
BR-R2000	-	-	-	-	Standard	Option	Standard	
BR-CX50	-	-	-	-	Standard	-	-	
BR-R561	-	Option	-	-	-	-	-	
BR-R451	-	-	-	-	Standard	-	-	

# Brake shoe recommendation to rim width

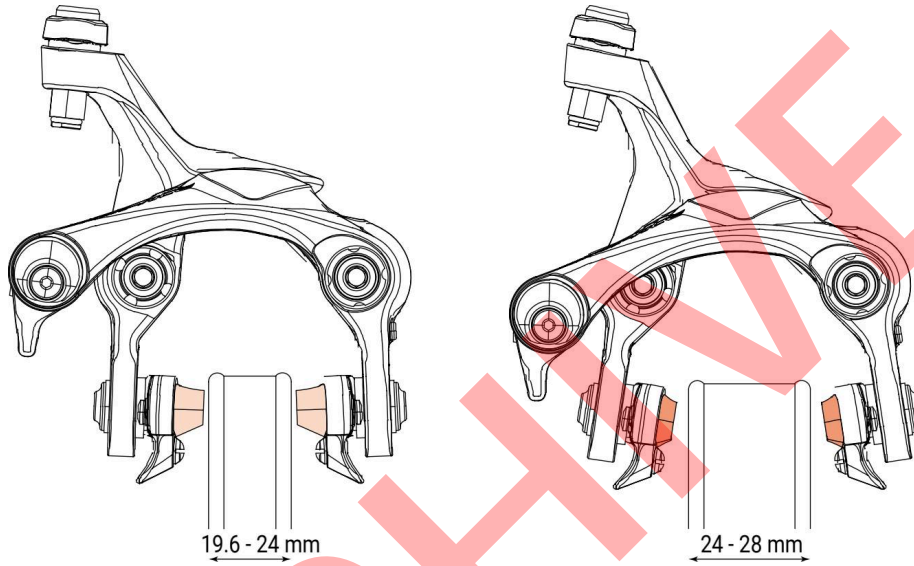
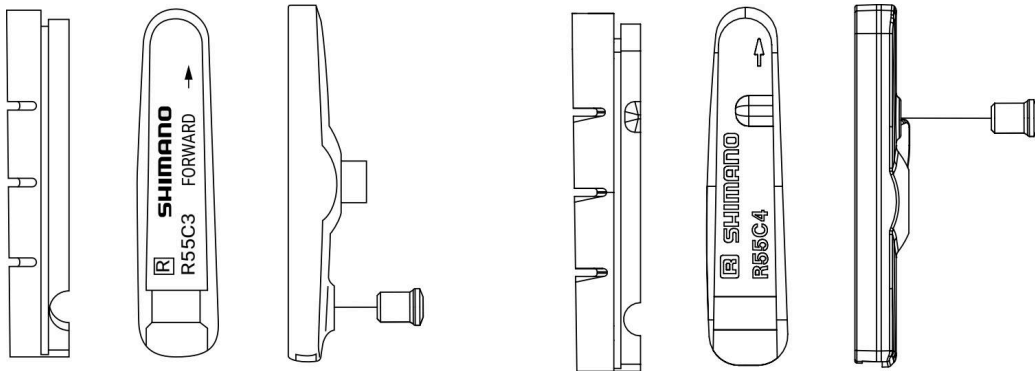

Model No.	Rim width
R55C4 / R55C4 for Carbon rim	19.6 - 24 mm
R55C3 / R55C3 for Carbon rim	
R55C4-A for Carbon rim	24 - 28 mm

## Polymer-coated brake cable (BC-9000 / BC-R680) compatible chart

C-306





Series	Brake with polymer-coated brake cable	
DURA-ACE	BR-R9200	✓
	BR-R9210	
	BR-R9100	
	BR-R9110	
ULTEGRA	BR-R8100	✓
	BR-R8110	
	BR-RS811-R	
	BR-R8000	
	BR-R8010	
SHIMANO 105	BR-R7000	✓
	BR-R7010	
	BR-5810	
	BR-5700	-
TIAGRA	BR-4700	✓
SORA	BR-R3000	✓
SHIMANO CLARIS	BR-R2000	✓
	Others	-

ARCHIVE

## Compatibility between brake systems

Depending on the brake and brake lever combination to be used, the relationship between the input at the brake lever and the actual braking force output at the wheels is very easily affected.

Be very careful when combining a brake and brake lever. Incorrect combinations can cause accidents or insufficient braking forces due to improper cable strokes. Be sure to carefully consult the chart below and select the brake and the matching brake lever.

		V-BRAKE		Roller Brake
		BR-T780 BR-MX70 BR-R573 BR-R463 BR-R353 BR-T670 BR-T610 BR-T4010 BR-T4000	With POWER MODULATOR* model BR-T780 with SM-PM70 BR-T670 with SM-PM70 BR-T610 with SM-PM70 BR-T4010 with SM-PM40 BR-T4000 with SM-PM40 BR-R573 with SM-PM70 BR-R463 with SM-PM40 BR-R353 with SM-PM70	BR-C6061-F BR-C6060-F BR-C6051-F BR-C6050-F BR-C6001 BR-C6000 BR-C3011 BR-C3010 BR-C3001 BR-C3000
V-BRAKE Levers (2-finger)				
ST-M4000 ST-EF41 ST-TX800 ST-M370 ST-M310 ST-EF510 ST-EF500 ST-EF65	BL-T610 BL-M571 BL-T4000 BL-MX70	✓	✓	
V-BRAKE Levers (3-finger)				
ST-T4000 ST-T3000	BL-T780 BL-T611 BL-T670 BL-T780-B BL-T4010 BL-T670-B		✓	
Brake Levers with switch				
ST-R240	BL-R780 BL-4700 BL-R3000 BL-R2000 BL-2400	✓	✓	NOTE
V-BRAKE lever with switch				
ST-M310 (4-finger) ST-EF65 (4-finger) ST-EF510 (4-finger) ST-EF500 (4-finger) BL-C6000			✓	NOTE
BL-C6010 SB-C6000-8 SB-C3000-7				✓

\* POWER MODULATOR must be used for front brake



The "NO!" symbols indicate combinations that should not be used under any circumstances.

### NOTE

This combination will not provide the sufficient amount of braking force.

# Brake lever with switch compatibility

Four finger brake levers such as brake levers are equipped with a switch to change between the V-BRAKE with modulator mode (for example with SM-PM40) and the caliper brake or roller brake mode.

## For V-BRAKE (with POWER MODULATOR) mode C-468

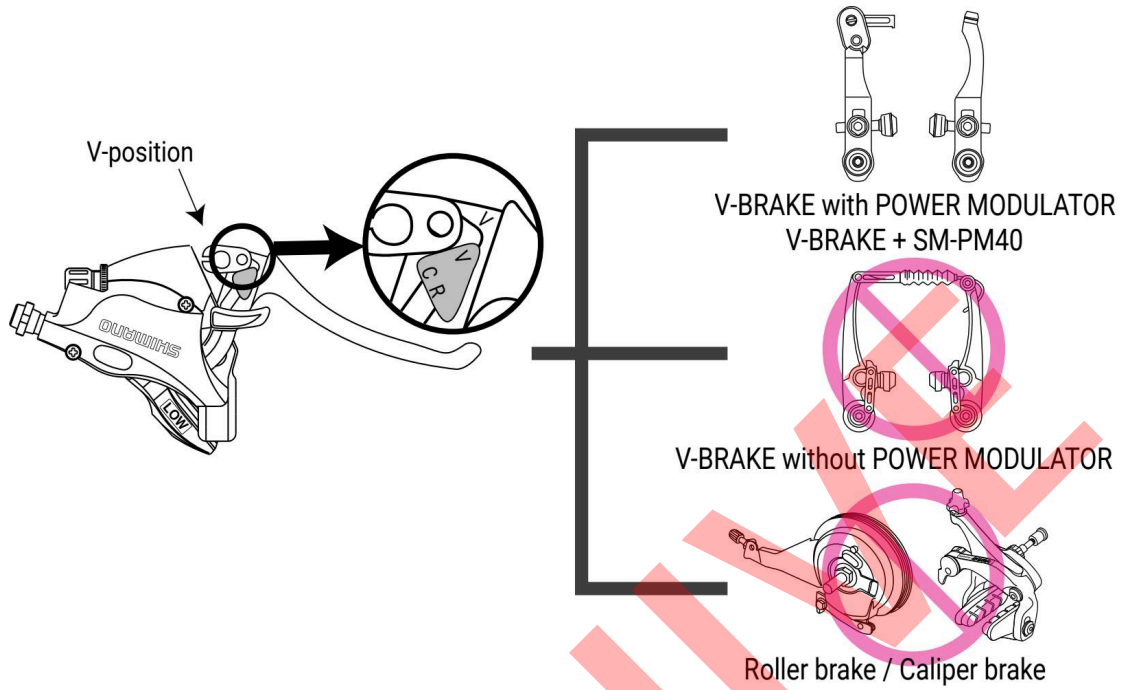

## For Caliper brake / Roller brake C-469

BL-C6010

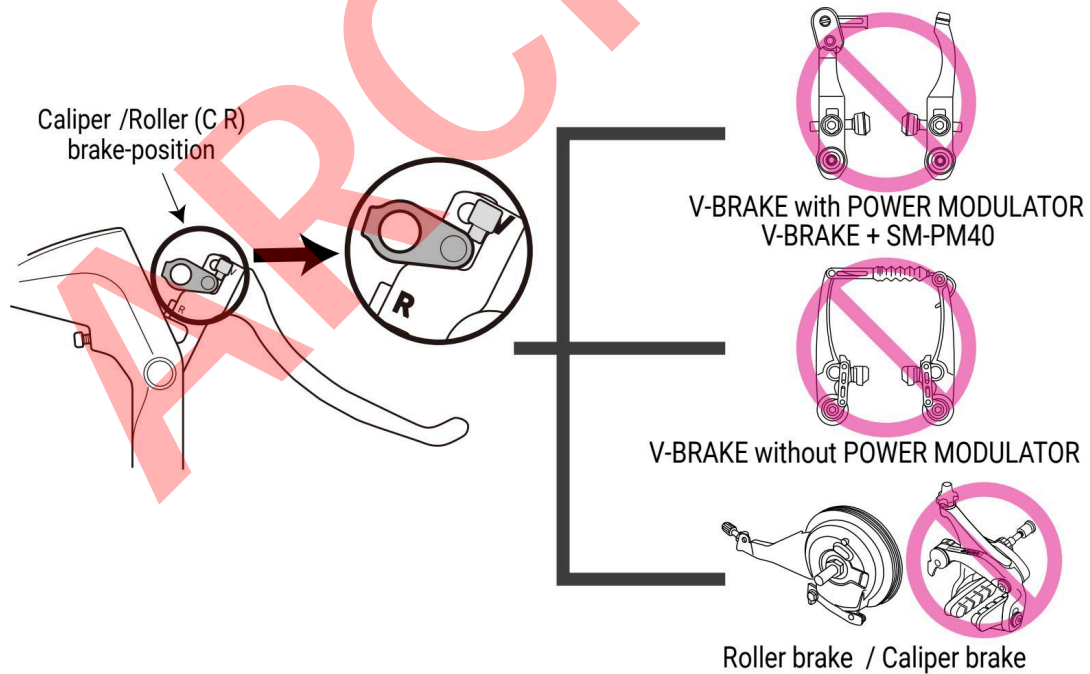

## Other models

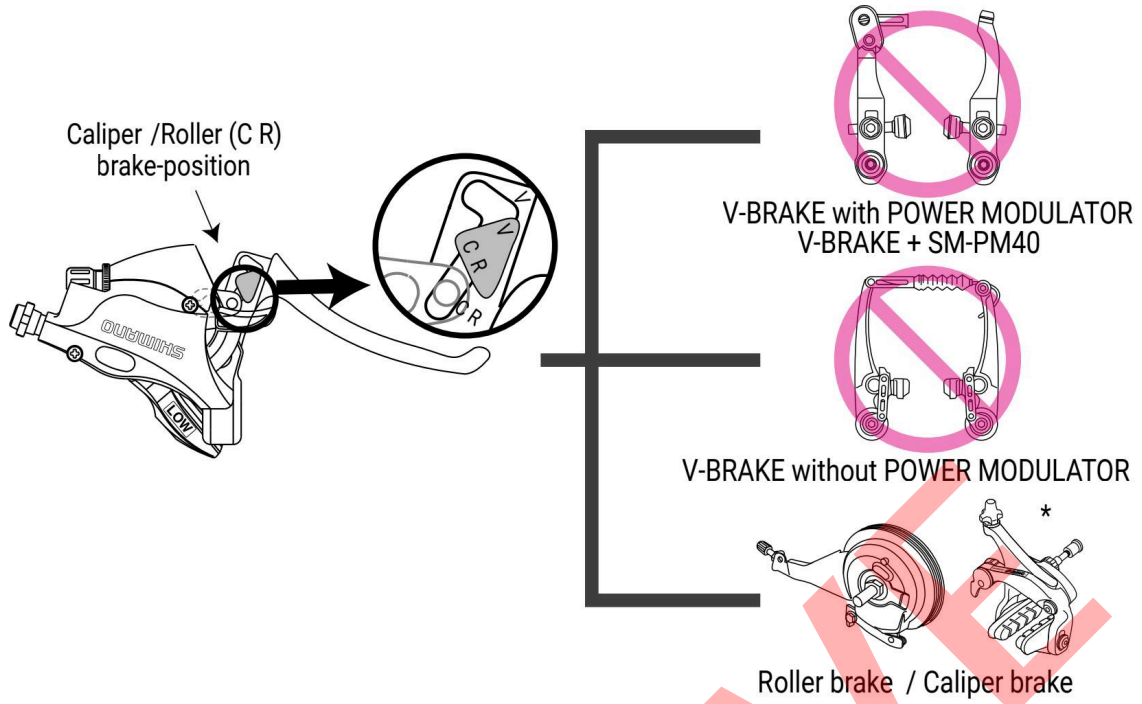

\* 3 types of caliper brake is available (SLR-EV / NEW SUPER SLR / SUPER SLR)

Please refer Spec Hand Book for caliper brake compatibility.

Some models can't be used with roller brake, please refer to [C-466](#) for more information.

### WARNING

If the mode is not matched to the type of brake being used, this could result in inadequate or excessive braking power. Please proceed with caution when selecting the correct mode for the corresponding brake.

## FREEHUB and cassette spline compatibility

C-731

The table below does not include LINKGLIDE cassette. See [C-649](#) for LINKGLIDE cassette.

FREEHUB			Compatible cassette type					
Free unit type	Number of effective spline teeth	Outer body length (mm)	MTB		ROAD		All	
			12-speed	11-speed	12-speed	11-speed	10/9/8-speed	7-speed
MICRO SPLINE	23	26	✓	-	-	-	-	-
HG spline L2 (ROAD 12-speed dedicated)	18	37.65	-	-	✓	-	-	-
HG spline L (ROAD 12/11-speed)	9	36.75	-	✓ *1	✓	✓ *3	✓ *2	-
HG spline M (10/9/8/7-speed, MTB 11-speed)	9	34.9	-	✓	-	- *4	✓ *5	✓ *6
HG spline S (7-speed)	9	31	-	-	-	-	-	✓ *7

\*1 Need 1.85 mm low spacer.

\*2 Need 1.85 mm low spacer and 1.0 mm spacer for the cassette below.

CS-7900 / CS-7800 / CS-6700 / CS-6600 / CS-5700 / CS-5600 (1.0 mm spacer is included)

\*3 CS-HG800 / CS-HG700 / [CS-RS400](#) of ROAD 11-speed are compatible with HG spline L by installing 1.85 mm spacer.

\*4 CS-HG800 / CS-HG700 / [CS-RS400](#) of ROAD 11-speed are compatible with HG spline M.

\*5 Need 1.0 mm spacer for the 10-speed ROAD cassettes below.

CS-7900 / CS-7800 / CS-6700 / CS-6600 / CS-5700 / CS-5600

\*6 Only CS-HG210-7 and CS-HG400-7 are compatible.

\*7 Only CS-HG41-7, CS-HG200-7 and CS-HG20-7 are compatible.

### Outer body length

Outer body length is length from the contact surface of the cassette of the free unit to the tip of the free unit.

#### MICRO SPLINE

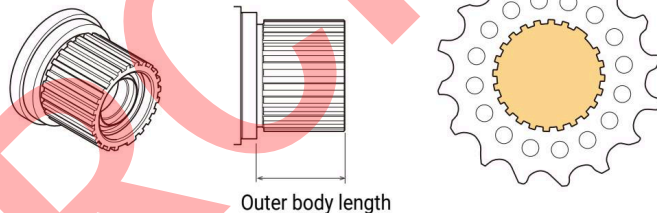

#### HG spline L2

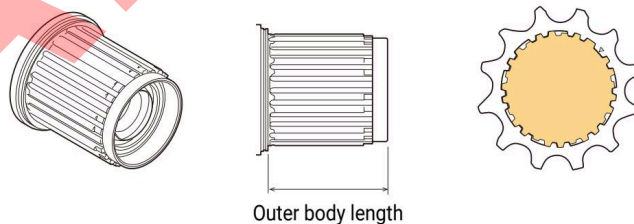

#### HG spline L/M/S

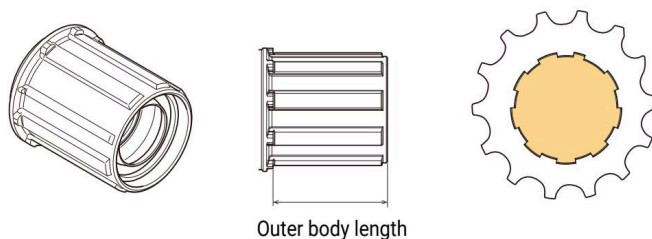

## ROAD 12/11-speed FREEHUB compatibility

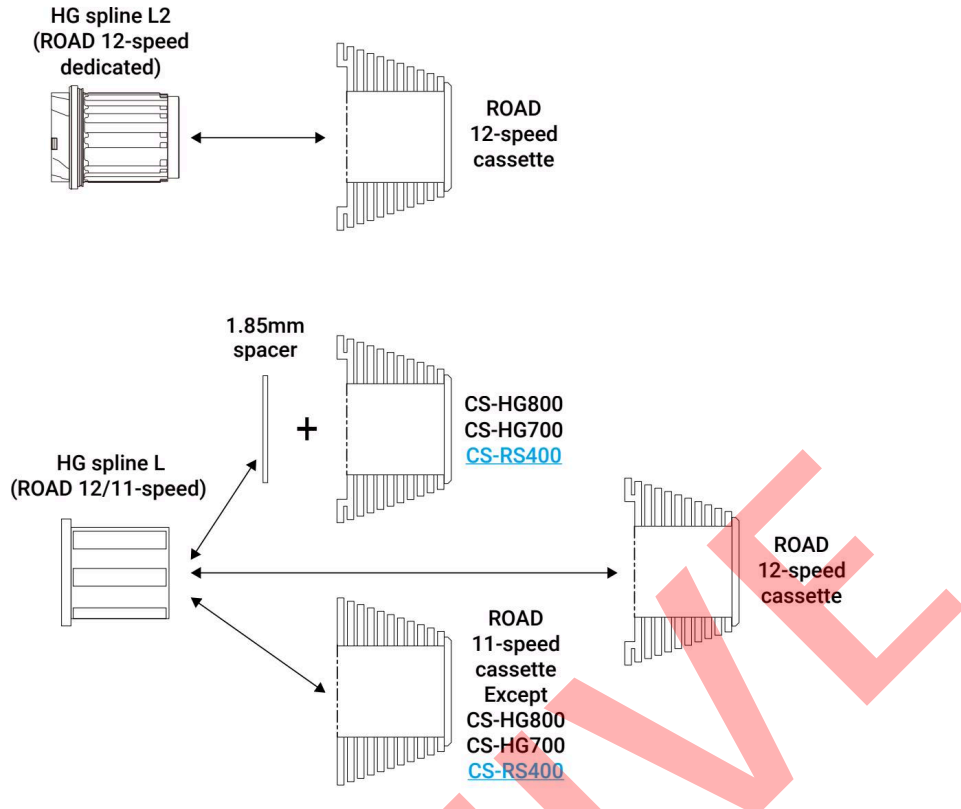





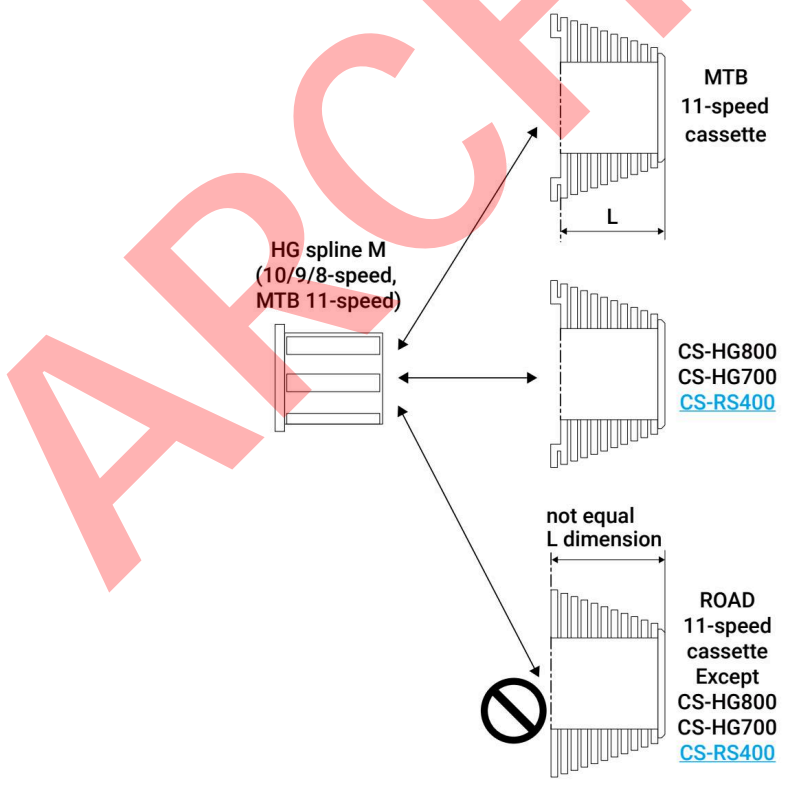

## MTB 11-speed FREEHUB compatibility

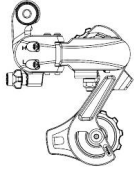
MTB 11-speed wheel and FREEHUB have same spline shape with 10, 9, 8-speed FREEHUB.

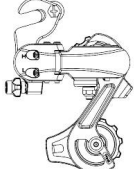

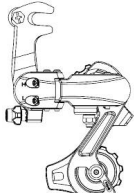
# 7-speed rear derailleur and FREEHUB compatibility

Type of rear derailleur	Type of compatible derailleur hanger and dropout	Free unit type of FREEHUB	
		HG spline S	HG spline M
Direct attachment compatible 		✓	✓
Riveted adapter (BMX-track type) compatible 		✓	
Riveted adapter (ROAD type) compatible 		✓	

ARCHIVE

# Compatibility between rear derailleur and cassette gear teeth [ROAD, Gravel, METREA]

## 12-speed C-648

Gear teeth	RD-R9250	RD-R8150	RD-R7100	RD-R7150
11-30T	✓	✓	-	-
11-34T	✓	✓	✓	✓
11-36T	-	-	✓	✓

Gear teeth	RD-RX820	RD-RX822	RD-RX822	RD-RX825	<a href="#">RD-RX827</a>	<a href="#">RD-RX717</a>
	- Front double	GS Front single	SGS Front single	- Front double	SGS Front single	SGS Front single
10-45T	-	✓	-	-	-	-
10-51T	-	-	✓	-	✓	✓
11-34T	✓	-	-	✓	-	-
11-36T	✓	-	-	✓	-	-

## 11-speed C-255

Gear teeth	RD-R9100 RD-R9150	RD-R8000 RD-R8050		RD-R7000		<a href="#">RD-R4000</a>	RD-9000
	-	SS	GS Front double	SS	GS Front double	-	SS
11-23T	-	-	-	-	-	-	✓
11-25T	✓	✓	-	-	-	-	✓
11-28T	✓	✓	✓	✓	✓	-	✓
11-30T	✓	✓	✓	✓	✓	-	-
11-32T	-	-	✓	-	✓	-	-
11-34T	-	-	✓	-	✓	-	-
11-36T	-	-	-	-	-	✓	-
11-40T	-	-	-	-	-	-	-
11-42T	-	-	-	-	-	-	-
12-25T	✓	✓	-	✓	-	-	✓
12-28T	✓	✓	✓	-	✓	-	✓
14-28T	✓	✓	-	✓	-	-	✓

Gear teeth	RD-6800 RD-6870 RD-5800	RD-RX800 RD-RX805	RD-RX810 RD-RX815	RD-RX812 RD-RX817	RD-U5000-SS
	SS	GS Front double	GS Front double	Closer Front double	Wider Front single
11-23T	✓	-	-	-	-
11-25T	✓	-	-	-	-
11-28T	✓	✓	✓	-	✓
11-30T	-	✓	✓	✓	✓
11-32T	-	✓	✓	✓	✓
11-34T	-	-	✓	✓	-
11-36T	-	-	-	-	-
11-40T	-	-	-	✓	-
11-42T	-	-	-	✓	-
12-25T	✓	-	-	-	-
12-28T	✓	✓	-	-	-
14-28T	✓	-	-	-	-

## 10-speed C-256

Gear teeth	RD-4700			RD-4601			RD-RX400
	SS	GS Front double	GS Front triple	SS	GS Front double	GS Front triple	Closer Front double
11-25T	✓	-	✓	✓	-	✓	-
11-27T	✓	-	✓	✓	✓	✓	-
11-28T	-	✓	✓	✓	✓	✓	-
11-32T	-	✓	✓	-	✓	-	✓
11-34T	-	✓	-	-	-	-	✓
11-36T	-	-	-	-	-	-	✓
12-25T	✓	-	✓	✓	-	✓	-
12-27T	✓	-	✓	✓	✓	✓	-
12-28T	✓	✓	✓	✓	✓	✓	-
12-30T	-	✓	✓	✓	✓	✓	-
13-25T	✓	-	-	✓	-	✓	-
14-25T	✓	-	-	✓	-	✓	-

## 9-speed C-257

Gear teeth	RD-R3000		
	SS	GS Front double	GS Front triple
11-25T	✓	-	-
11-28T	✓	✓	✓
11-30T	✓	✓	✓
11-32T	✓	✓	✓
11-34T	-	✓	-
12-25T	✓	-	-
12-27T	✓	-	-
13-25T	✓	-	-
14-25T	✓	-	-

## 8-speed C-258

Gear teeth	RD-R2000		
	SS	GS Front double	GS Front triple
11-28T	✓	✓	✓
11-30T	✓	✓	✓
11-32T	✓	✓	✓
11-34T	-	✓	-
12-25T	✓	-	✓
13-26T	✓	-	-

## 7-speed C-259

Gear teeth	RD-A070
	SMART CAGE
11-28T	✓
12-28T	✓
13-28T	✓
14-28T	✓

# LINKGLIDE cassette and FREEHUB compatibility

LINKGLIDE cassette are not compatible with MICRO SPLINE FREEHUB.



Freewheel body type	FREEHUB spec.	Model No.	CS-LG700-11 CS-LG600-11 CS-LG400-11	CS-LG600-10 CS-LG400-10 CS-LG300-10	CS-LG400-9 CS-LG300-9
HG spline M (10/9/8-speed, MTB 11-speed, 7-speed CS-HG400-7 / CS-HG210-7)	O.L.D. 148 mm, E-THRU type	FH-M8010-B	✓	✓	✓
		FH-M6010-B			
		FH-TC600-HM-B			
		FH-TC500-HM-B			
		FH-MT400-B			
	O.L.D. 141 mm, Quick release type	FH-MT200-B	✓	✓	✓
		FH-QC400-HM-B			
	O.L.D. 150 mm, E-THRU type	FH-M825	✓	✓	✓
	O.L.D. 135 mm, E-THRU type	FH-M820	- *2	✓	✓
	O.L.D. 142 mm, E-THRU type	FH-M8010	- *2	✓	✓
		FH-M6010			
		FH-MT400			
		FH-TC500-HM			
	O.L.D. 135 mm, Quick release type	FH-M9000	- *2	✓	✓
		FH-M8000			
		FH-M6000			
		FH-M4050			
		FH-M3050			
		FH-RM35			
		FH-TX505-8			
		FH-M756-A			
		FH-M525			
		FH-M475			
FH-TX506					
FH-T610					
FH-T3000					
FH-TX500-8-QR					
FH-TX500-8-NT					
FH-QC400-HM					
FH-QC300-HM		✓			
FH-M5100					
FH-QB400-HM					
O.L.D. 130 mm, Quick release type	FH-RS300	- *2	✓	✓	
O.L.D. 135 mm, Nut type	FH-NN300-HM	✓	✓	✓	
HG spline L (ROAD 12/11-speed)	O.L.D. 142 mm, E-THRU type	FH-TC500-HL	✓ *1	✓ *1	✓ *1
		FH-R7070			
		FH-RS770			
	O.L.D. 135 mm, Quick release type	FH-RS470	✓ *1	✓ *1	✓ *1
		FH-UR600			
	O.L.D. 130 mm, Quick release type	FH-R7000	- *2	✓ *1	✓ *1
FH-RS400					

\*1 Need low spacer (1.85 mm.)

\*2 Interference may occur with the rear derailleur and spokes.

## Available combinations of the dropout, sprocket and crankset for designing the frame

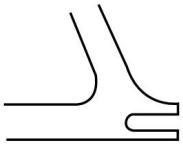
C-471

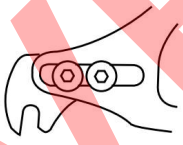
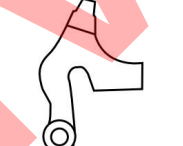
Dropout design	A	Reversed (BMX) type, without derailleur hanger	
	B	Standard type, without derailleur hanger	
	C	Adjustable disc brake mount / Eccentric bottom bracket	
	D	Vertical type, with derailleur hanger	
Compatibility		NR: Not recommend	-
Crankset	E	FC-C6000	-
	F	FC-S501: Double guard spec	-
	G	FC-S501: Single guard spec	-
	K	SM-CRE61 / SM-CRE50	-
CN	H	CN-NX10 (1/2 x 1/8 inch) or HG 8S (1/2 x 3/32 inch)	-
	I	Super Narrow HG 9S	-
	J	HG 8S (1/2 x 3/32 inch)	-

Series	Speed	Brake type	Dropout design	Compatibility	Chain tensioner *5	Sprocket	FC	CN	additional condition
ALFINE	11S / 8S	Disc brake	A	NR	-	-	-	-	*1
			B	NR	-	-	-		
			C	OK	-	SM-GEAR	G	J	-
			D	OK	CT-S500	CS-S500	F	I	-
		V-BRAKE	A	OK	-	SM-GEAR	G	J	-
			B	OK	-	SM-GEAR	G	J	-
			C	OK	-	SM-GEAR	G	J	-
			D	OK	CT-S500	CS-S500	F	I	-
NEXUS	8S / 7S	Disc brake	A	NR	-	-	-	-	*1
			B	NR	-	-	-		
			C	OK	-	SM-GEAR	G	J	-
			D	OK	CT-S500	CS-S500	F	I	-
	8S / 7S / 3S (except 3D)	Roller brake V-BRAKE	A	OK	-	SM-GEAR	G	J	-
			B	OK	-	SM-GEAR	E	H	-
			C	OK	-	SM-GEAR	E	H	-
			D	NR	CT-S500 (except 3s)	CS-S500	F	I	*2
		Coaster brake	A	OK	-	SM-GEAR	G	J	-
			B	OK	-	SM-GEAR	E	H	-
			C	OK	-	SM-GEAR	E	H	-
			D	NR	-	-	-	-	*3
			D	NR	-	-	-	-	*4
			A	OK	-	SM-GEAR	G	J	-
			B	OK	-	SM-GEAR	G	J	-
			C	OK	-	SM-GEAR	G	J	-
	3D	Disc brake	A	NR	-	-	-	-	*1
			B	NR	-	-	-		
			C	OK	-	SM-GEAR	G	J	-
			D	NR	-	-	-	-	-
	5S for E-BIKE	Disc brake	A	OK	-	SM-GEAR	G	J	-
			B	OK	-	SM-GEAR	G	J	-
			C	OK	-	SM-GEAR	G	J	-
			D	NR	-	-	-	-	-
		Roller brake V-BRAKE	A	NR	-	-	-	-	*1
			B	NR	-	-	-	-	
			C	OK	-	CS-C7000	K	J	-
			D	NR	-	-	-	-	-
Coaster brake	A	OK	-	CS-C7000	K	J	-		
	B	OK	-	CS-C7000	K	J	-		
	C	OK	-	CS-C7000	K	J	-		
	D	NR	-	-	-	-	-		

\*1 Special disc brake mount design is needed.

\*2 without chain guard for hub gear side.

\*3 Structure of CT-S500 can't transfer chain tension by back pedaling.

\*4 Not enough force of fixation against back pedaling power.

\*5 Chain tensioners are not compatible with MU-UR510.

# Mechanical internal geared hub / SM (CJ) COMPATIBILITY CHART

C-647

Internal Geared Hub (SG)		Spec.	Small Parts Set (SM)	Cassette Joint (CJ) * CJ is included in SM parts set
ALFINE-11	SG-S7001-11	11s, Disc brake, Premium	SM-S700 SM-S700-BD *1	CJ-S700 CJ-S700-BD *1
ALFINE-8	SG-S7001-8	8s, Disc brake, Premium	SM-S7000-8 SM-S7000-8BD *1	CJ-S7000-8 CJ-S7000-8BD *1
INTER-8	SG-C6011-8R	8s, Roller brake, Premium	SM-8S31 SM-8S31BD *1	CJ-8S20 / CJ-8S40 CJ-8S20BD *1
	SG-C6011-8V	8s, V-BRAKE, Premium		
	SG-C6001-8R	8s, Roller brake		
	SG-C6001-8V	8s, V-BRAKE		
	SG-C6001-8C	8s, Coaster brake		
	SG-C6001-8D	8s, Disc brake		
	SG-C6001-8CD	8s, Coaster brake & Disc brake		
INTER-7	SG-C3001-7R	7s, Roller brake	SM-7R45 SM-7C25 *1	CJ-NX10 / CJ-NX40
		7s, V-BRAKE		
	SG-C3001-7C	7s, Coaster brake	SM-7C25	CJ-NX10 / CJ-NX40
	SG-C3001-7D	7s, Disc brake	SM-7R45 SM-7C25 *1	CJ-NX10 / CJ-NX40
INTER-5E	SG-C7000-5R	5s, Roller brake, Premium	SM-C7000-5 SM-C7000-5BD *1	CJ-C7000-5 CJ-C7000-5BD *1
	SG-C7000-5V	5s, V-BRAKE, Premium		
	SG-C7000-5C	5s, Coaster brake, Premium		
	SG-C7000-5D	5s, Disc brake, Premium		
	SG-C7002-5CD	5s, Coaster brake & Disc brake		
INTER-5	SG-5R30 (Japan Only)	5s, Roller brake, Japan only	SM-5S30	CJ-8S20 / CJ-8S40
	SG-5R30-VS (Japan Only)	5s, V-BRAKE, Japan only		
	SG-5R35 (Japan Only)	5s, Roller brake, Alloy body, Japan only		
	SG-5R35-VS (Japan Only)	5s, V-BRAKE, Alloy body, Japan only		
INTER-3	SG-3R42 (Japan Only)	3s, Roller brake, Japan only	SM-3R40	-
	SG-3R40 (Japan Only)	-		
	SG-3R40	3s, Roller brake	SM-3R40	SM-BC03 SM-BC06
	SG-3C41	3s, Coaster brake	SM-3R41	-
	SG-3D55	3s, Disc brake	SM-3D55	SM-BC03 SM-BC06
	SG-3R75	3s, Roller brake, Premium	SM-3S70	CJ-NX10 / CJ-NX40

\*1 Dedicated specs for belt drive system

## Sprocket and chain combination

C-608

Series	Sprocket		Chain Model No.
	Model No.	Gear thickness (mm)	
ALFINE	CS-S500	2.0	CN-E6090-10
			CN-E6070-9
NEXUS	SM-GEAR (2.3 mm)	2.3	CN-HG93
	CS-C7000		CN-HG53
	SM-GEAR (3.0 mm)	3.0	CN-HG71
			CN-HG40
			CN-NX10

## Compatibility for DIN 79010:2020-02

C-672

### DIN 79010:2020-02

Fahrräder - Transport- und Lastenfahrrad - Anforderungen und Prüfverfahren für ein- und mehrspurige  
Fahrräder

(Cycles - Transportation bikes and cargo bikes - Requirements and test methods for single- and multi-track  
cycles)

Products		Model No.	DIN 79010:2020-02 (Type 1: Single Track) conformance
BRAKE (BR, RT)	Group #1	BR-M9120 / BR-M8120 / BR-M7120 + RT-MT900 / RT-EM910	YES with conditions (*1)
	Group #2	BR-M9120 / BR-M8120 / BR-M7120 + RT-MT800 / RT-EM810	
	Group #3	BR-M9120 / BR-M8120 / BR-M7120 + SM-RT86	
	Group #4	BR-M6120 + <a href="#">RT-CL300</a> / SM-RT30 / RT-EM300 / SM-RT66	
	Group #5	BR-MT520 / BR-MT420 + <a href="#">RT-CL300</a> / SM-RT30 / RT-EM300 / SM-RT66	
HUB (HB, FH, SG)	FH	FH-M**** / MT*** / TX*** / RS*** / UR*** series	YES (*SHIMANO can't guarantee assembled wheel performance. Please confirm wheel performance by bike manufacturer.)
	SG	SG-C7000-5D / SG-C7050-5D / SG-C6001-8D / SG-C6061-8D SG-C3001-7D	
	HB	HB-M**** / MT*** / TX*** / RS*** series	
	DH	All	
OTHERS	All not mentioned above (DU, CS, CN, RD, FC, etc.)	All	NO YES No special requirement if compare with ISO/EN4210-2 2015

### (\*1) conditions

#### Product Spec requirements

	Brake pad	RT size	Hose length (*Please consider Brake Lever reach adjustment)
Group #1,2,3	Resin pad w/ radiator fin	203 mm (L size)	2200 mm or less (Tire outer diameter = 660 mm or less) 2400 mm or less (Tire outer diameter = 559 mm or less) 2700 mm or less (Tire outer diameter = 406 mm or less)
		180 mm (M size)	1300 mm or less (Tire outer diameter = 660 mm or less) 2000 mm or less (Tire outer diameter = 559 mm or less) 2400 mm or less (Tire outer diameter = 406 mm or less)
Group #4	Resin pad w/o radiator fin	203 mm (L size)	2200 mm or less (Tire outer diameter = 660 mm or less) 2400 mm or less (Tire outer diameter = 559 mm or less) 2700 mm or less (Tire outer diameter = 406 mm or less)
		180 mm (M size)	1300 mm or less (Tire outer diameter = 660 mm or less) 2000 mm or less (Tire outer diameter = 559 mm or less) 2400 mm or less (Tire outer diameter = 406 mm or less)
Group #5	Resin pad w/o radiator fin	203 mm (L size)	3000 mm or less (Tire outer diameter = 660 mm or less)
		180 mm (M size)	

## Limitation & adjustment

	RT size	DIN 79010:2020-02 5.5.2.2.2 Weight factor "c" (*2)	Brake lever adjustment
Group #1	203 mm (L size)	c = 1.5	Brake lever reach adjustment might be required to follow minimum braking force value of 5.5.1.3
	180 mm (M size)	c = 1.4	
Group #2	203 mm (L size)	c = 1.4	
	180 mm (M size)	c = 1.3	
Group #3	203 mm (L size)	c = 1.3	
	180 mm (M size)	c = 1.1	
Group #4,5	203 mm (L size)	c = 1.1	
	180 mm (M size)	c = 0.9	

**(\*2) Refer to DIN 79010:2020-02 5.5.2.2.2 about "c" value.**

c: weight factor which is defined by bike design.  $c = (AL: \text{axle load}) / (M: 100 \text{ kgf as basic value})$ .

For example, axle load is allowed till 150 kgf if  $c = 1.5$ .

ARCHIVE

## Spoke protector

C-491

Select the spoke protector after checking the chart below.

It is decided by hole number of hub and number of the gear teeth, other than multiple freewheel.

Cassette		Spoke protector model																	
		Flange diameter of rear hub (FH side)																	
		53.8 mm						70.6 mm											
Speed	Model No.	Number of largest sprocket teeth											Spoke hole number			Spoke hole number			
		25T	28T	30T	32T	34T	36T	40T	42T	45T	46T	51T	28H	32H	36H	28H	32H	36H	
12-speed	CS-M9200-12	-	-	-	-	-	-	-	-	✓	-	✓	-	-	-	-	-	-	-
	CS-M8200-12	-	-	-	-	-	-	-	-	✓	-	✓	-	-	-	-	-	-	-
	CS-M9101-12	-	-	-	-	-	-	-	-	✓	-	✓	-	-	-	-	-	-	-
	CS-M9100-12	-	-	-	-	-	-	-	-	✓	-	✓	-	-	-	-	-	-	-
	CS-M8100-12	-	-	-	-	-	-	-	-	✓	-	✓	-	-	-	-	-	-	-
	CS-M7100-12	-	-	-	-	-	-	-	-	✓	-	✓	-	-	-	-	-	-	-
11-speed	CS-M6100-12	-	-	-	-	-	-	-	-	✓	-	✓	-	-	-	-	-	-	-
	CS-M9001	-	-	-	-	-	-	✓	-	-	-	-	-	-	-	-	-	-	-
	CS-M8000	-	-	-	-	-	-	✓	✓	-	✓	-	-	-	-	-	-	-	-
	CS-M7000	-	-	-	-	-	-	✓	✓	-	✓	-	-	-	-	-	-	-	-
10-speed	CS-M5100-11	-	-	-	-	-	-	-	✓	-	-	✓	-	-	-	-	-	-	-
	CS-M4100-10	-	-	-	-	-	-	-	✓	-	✓	-	-	-	-	-	-	-	-
	CS-M771-10	-	-	-	✓	✓	✓	-	-	-	-	-	-	CP-FH56	CP-FH53	-	CP-FH76	CP-FH76	-
	CS-HG81-10	-	-	-	✓	✓	✓	-	-	-	-	-	-	CP-FH56	CP-FH53	-	CP-FH76	CP-FH76	-
	CS-HG500-10	✓	✓	-	✓	✓	-	-	✓	-	-	-	-	-	-	-	-	-	-
	CS-HG50-10	-	-	-	-	-	✓	-	-	-	-	-	-	-	CP-FH56	CP-FH53	-	-	-
9-speed	CS-HG400-9	-	-	-	-	-	✓	-	-	-	-	-	-	CP-FH56	CP-FH53	-	CP-FH76	CP-FH76	-
	CS-HG300-9	-	-	-	-	-	✓	-	-	-	-	-	-	CP-FH56	CP-FH53	-	CP-FH76	CP-FH76	-
	CS-HG201-9	-	-	-	-	-	✓	-	-	-	-	-	-	CP-FH56	CP-FH53	-	CP-FH76	CP-FH76	-
	CS-HG200-9	-	-	-	-	-	✓	-	-	-	-	-	-	CP-FH56	CP-FH53	-	CP-FH76	CP-FH76	-
	CS-HG400-9	-	-	-	✓	✓	-	-	-	-	-	-	CP-WH12	CP-FH56	CP-FH53	-	CP-FH76	CP-FH76	-
	CS-HG300-9	-	-	-	✓	✓	-	-	-	-	-	-	CP-WH12	CP-FH56	CP-FH53	-	CP-FH76	CP-FH76	-
	CS-HG201-9	-	-	-	✓	✓	-	-	-	-	-	-	CP-WH12	CP-FH56	CP-FH53	-	CP-FH76	CP-FH76	-
	CS-HG200-9	-	-	-	✓	✓	-	-	-	-	-	-	CP-WH12	CP-FH56	CP-FH53	-	CP-FH76	CP-FH76	-
8-speed	CS-HG400-9	-	✓	-	-	-	-	-	-	-	-	-	CP-FH35	CP-FH50	-	CP-FH76	CP-FH76	-	-
	CS-HG300-9	-	✓	-	-	-	-	-	-	-	-	-	CP-FH35	CP-FH50	-	CP-FH76	CP-FH76	-	-
	CS-ROAD	-	✓	-	-	-	-	-	-	-	-	-	CP-FH08	CP-FH35	CP-FH31	-	-	-	-
	CS-HG60-81	-	-	-	-	✓	-	-	-	-	-	-	CP-FH08	CP-FH35	CP-FH31	-	-	-	-
	CS-HG51-8	-	✓	✓	-	-	-	-	-	-	-	-	CP-WH12	CP-FH56	CP-FH53	-	CP-FH76	CP-FH76	-
	CS-HG51-8	-	✓	✓	-	-	-	-	-	-	-	-	CP-WH12	CP-FH56	CP-FH53	-	CP-FH76	CP-FH76	-
	CS-HG41-8	-	-	✓	-	-	-	-	-	-	-	-	CP-FH40	CP-FH35	CP-FH50	-	-	-	-
	CS-HG31-8	-	-	✓	-	-	-	-	-	-	-	-	CP-FH40	CP-FH35	CP-FH50	-	-	-	-
	CS-HG41-8	-	-	-	✓	✓	-	-	-	-	-	-	CP-WH12	CP-FH56	CP-FH53	-	CP-FH76	CP-FH76	-
	CS-HG31-8	-	-	-	✓	✓	-	-	-	-	-	-	CP-WH12	CP-FH56	CP-FH53	-	CP-FH76	CP-FH76	-
7-speed	CS-HG400-8	-	-	-	-	-	-	✓	-	✓	-	-	-	-	-	-	-	-	-
	CS-HG300-8	-	-	-	-	-	-	✓	-	✓	-	-	-	-	-	-	-	-	-
	CS-HG200-8	-	-	-	-	-	-	✓	-	✓	-	-	-	-	-	-	-	-	-
	CS-HG200-8	-	-	-	✓	-	-	-	-	-	-	-	CP-WH12	CP-FH56	CP-FH53	-	CP-FH76	CP-FH76	-
	CS-HG41-7	-	✓	-	-	-	-	-	-	-	-	-	CP-FH40	CP-FH35	CP-FH50	-	-	-	-
	CS-HG400-7	-	✓	-	-	-	-	-	-	-	-	-	CP-FH40	CP-FH35	CP-FH50	-	-	-	-
	CS-HG210-7	-	✓	-	-	-	-	-	-	-	-	-	-	-	-	-	-	-	-
	CS-HG210-7	-	✓	-	-	-	-	-	-	-	-	-	-	-	-	-	-	-	-
7-speed	CS-HG200-7	-	-	-	✓	-	-	-	-	-	-	-	-	CP-FH56	CP-FH53	-	CP-FH76	CP-FH76	-
	CS-HG200-7	-	-	-	✓	-	-	-	-	-	-	-	-	CP-FH56	CP-FH53	-	CP-FH76	CP-FH76	-
7-speed	CS-HG200-7	-	✓	-	-	-	-	-	-	-	-	-	-	CP-FH35	CP-FH50	-	-	-	-
	CS-HG200-7	-	✓	-	-	-	-	-	-	-	-	-	-	CP-FH35	CP-FH50	-	-	-	-

## 12-speed

### [CS-M9200-12](#), [CS-M8200-12](#)

Model No.	Cassette		Spoke protector model		
	Number of largest sprocket teeth		45T	51T	
	45T	51T			
<a href="#">CS-M9200-12</a>	✓	✓	<a href="#">WH-M9200</a>	<a href="#">WH-M9220</a>	<a href="#">WH-M8200</a>
<a href="#">CS-M8200-12</a>	✓	✓	<a href="#">CP-WM92A</a>	<a href="#">CP-WM92A</a>	<a href="#">CP-WM92A</a>

### [CS-M9101-12](#), [CS-M9100-12](#), [CS-M8100-12](#), [CS-M7100-12](#), [CS-M6100-12](#)

Model No.	Cassette		Spoke protector model					<a href="#">WH-M9000</a> <a href="#">WH-M9020</a> <a href="#">WH-M8000</a> <a href="#">WH-M8020</a> <a href="#">WH-M8000-B</a> <a href="#">WH-M8020-B</a>
	Number of largest sprocket teeth		WH-M8100	WH-M8120	WH-MT620	WH-MT601	WH-MT501	
	45T	51T						
<a href="#">CS-M9101-12</a>	✓	✓	CP-WH28	CP-WH32 (for 10-45T) CP-WH29 (for 10-51T)	CP-WH31 (for 10-45T) CP-WRX8B CP-WH27 (for 10-51T)	CP-WH31 (for 10-45T) CP-WRX8B CP-WH27 (for 10-51T)	CP-WH31 (for 10-45T) CP-WRX8B	-
<a href="#">CS-M9100-12</a>	✓	✓						-
<a href="#">CS-M8100-12</a>	✓	✓						-
<a href="#">CS-M7100-12</a>	✓	✓						-
<a href="#">CS-M6100-12</a>	-	✓						-

Model No.	Cassette		Spoke protector model				
	Number of largest sprocket teeth		WH-MT600	WH-MT500	<a href="#">WH-MT35</a> <a href="#">WH-MT35-275</a> <a href="#">WH-MT35-29</a>	WH-RX880 (MICRO SPLINE)	<a href="#">WH-RX180</a> (MICRO SPLINE)
	45T	51T					
<a href="#">CS-M9101-12</a>	✓	✓	-	-	-	CP-WRX8B	<a href="#">CP-WR18B</a>
<a href="#">CS-M9100-12</a>	✓	✓	-	-	-		
<a href="#">CS-M8100-12</a>	✓	✓	-	-	-		
<a href="#">CS-M7100-12</a>	✓	✓	-	-	-		
<a href="#">CS-M6100-12</a>	-	✓	-	-	-		

## 11-speed

Model No.	Cassette						Spoke protector model				
	Number of largest sprocket teeth						WH-M8100	WH-M8120	WH-MT620	WH-MT601	WH-MT501
	40T	42T	45T	46T	50T	51T					
<a href="#">CS-M9001</a>	✓	-	-	-	-	-	-	-	-	-	
<a href="#">CS-M8000</a>	✓	✓	-	✓	-	-	-	-	-	-	
<a href="#">CS-M7000</a>	✓	✓	-	✓	-	-	-	-	-	-	
<a href="#">CS-M5100-11</a>	-	✓	-	-	-	✓	-	-	-	-	
<a href="#">CS-LG700-11</a>	-	-	✓	-	✓	-	-	-	-	-	
<a href="#">CS-LG600-11</a>	-	-	-	-	✓	-	-	-	-	-	
<a href="#">CS-LG400-11</a>	-	-	✓	-	✓	-	-	-	-	-	

Model No.	Cassette						Spoke protector model				
	Number of largest sprocket teeth						WH-RX870	<a href="#">WH-M9000</a> <a href="#">WH-M9020</a> <a href="#">WH-M8000</a> <a href="#">WH-M8020</a> <a href="#">WH-M8000-B</a> <a href="#">WH-M8020-B</a>	WH-MT600	WH-MT500	<a href="#">WH-MT35</a> <a href="#">WH-MT35-275</a> <a href="#">WH-MT35-29</a>
	40T	42T	45T	46T	50T	51T					
<a href="#">CS-M9001</a>	✓	-	-	-	-	-	CP-WH26 (for 40T or 42T)	CP-WH17-A	CP-WH26	-	-
<a href="#">CS-M8000</a>	✓	✓	-	✓	-	-		CP-WH17-A	CP-WH26	-	-
<a href="#">CS-M7000</a>	✓	✓	-	✓	-	-		CP-WH17-A	CP-WH26	-	-
<a href="#">CS-M5100-11</a>	-	✓	-	-	-	✓		CP-WH17-A (for 42T)	CP-WH26 (for 42T)	-	-
<a href="#">CS-LG700-11</a>	-	-	✓	-	✓	-		-	-	-	-
<a href="#">CS-LG600-11</a>	-	-	-	-	✓	-	-	-	-	-	
<a href="#">CS-LG400-11</a>	-	-	✓	-	✓	-	-	-	-	-	

## 10-speed

Model No.	Cassette								Spoke protector model				
	Number of largest sprocket teeth								WH-M8100	WH-M8120	WH-MT620	WH-MT601	WH-MT501
	32T	34T	36T	39T	42T	43T	46T	48T					
CS-M4100-10	-	-	-	-	✓	-	✓	-	-	-	-	-	-
CS-M771-10	✓	✓	✓	-	-	-	-	-	-	-	-	-	-
CS-HG81-10	-	✓	✓	-	-	-	-	-	-	-	-	-	-
CS-HG500-10	-	-	-	-	✓	-	-	-	-	-	-	-	-
CS-HG50-10	-	-	✓	-	-	-	-	-	-	-	-	-	-
CS-LG600-10	-	-	-	-	-	✓	-	-	-	-	-	-	-
CS-LG400-10	-	-	-	✓	-	✓	-	✓	-	-	-	-	-
CS-LG300-10	-	-	-	✓	-	-	-	✓	-	-	-	-	-

Model No.	Cassette								Spoke protector model			
	Number of largest sprocket teeth								WH-M9000 WH-M9020 WH-M8000 WH-M8020 WH-M8000-B WH-M8020-B	WH-MT600	WH-MT500	WH-MT35 WH-MT35-275 WH-MT35-29
	32T	34T	36T	39T	42T	43T	46T	48T				
CS-M4100-10	-	-	-	-	✓	-	✓	-	-	-	-	-
CS-M771-10	✓	✓	✓	-	-	-	-	-	-	CP-WH16	CP-WH21	CP-WH12
CS-HG81-10	-	✓	✓	-	-	-	-	-	-	CP-WH16	CP-WH21	CP-WH12
CS-HG500-10	-	-	-	-	✓	-	-	-	-	-	CP-WH21	CP-WH19
CS-HG50-10	-	-	✓	-	-	-	-	-	-	CP-WH16	CP-WH21	CP-WH12
CS-LG600-10	-	-	-	-	-	✓	-	-	-	CP-WH26	CP-WH21	-
CS-LG400-10	-	-	-	✓	-	✓	-	✓	-	-	-	-
CS-LG300-10	-	-	-	✓	-	-	-	✓	-	-	-	-

## 9-speed

Model No.	Cassette						Spoke protector model				
	Number of largest sprocket teeth						WH-M8100	WH-M8120	WH-MT620	WH-MT601	WH-MT501
	28T	32T	34T	36T	41T	46T					
CS-HG400-9	-	-	-	-	-	-	-	-	-	-	-
CS-HG300-9	-	✓	✓	✓	-	-	-	-	-	-	-
CS-HG201-9	-	-	-	-	-	-	-	-	-	-	-
CS-HG200-9	-	-	-	-	-	-	-	-	-	-	-
CS-HG400-9	✓	-	-	-	-	-	-	-	-	-	-
CS-HG300-9	-	-	-	-	-	-	-	-	-	-	-
CS-LG400-9	-	-	-	✓	✓	✓	-	-	-	-	-
CS-LG300-9	-	-	-	✓	✓	✓	-	-	-	-	-

Model No.	Cassette						Spoke protector model			
	Number of largest sprocket teeth						WH-M9000 WH-M9020 WH-M8000 WH-M8020 WH-M8000-B WH-M8020-B	WH-MT600	WH-MT500	WH-MT35 WH-MT35-275 WH-MT35-29
	28T	32T	34T	36T	41T	46T				
CS-HG400-9	-	-	-	-	-	-	-	-	-	-
CS-HG300-9	-	✓	✓	✓	-	-	-	-	-	CP-WH12
CS-HG201-9	-	-	-	-	-	-	-	-	-	-
CS-HG200-9	-	-	-	-	-	-	-	-	-	-
CS-HG400-9	✓	-	-	-	-	-	-	-	-	CP-WH08
CS-HG300-9	-	-	-	-	-	-	-	-	-	-
CS-LG400-9	-	-	-	✓	✓	✓	-	-	-	-
CS-LG300-9	-	-	-	✓	✓	✓	-	-	-	-

Model No.	Speed				Number of largest sprocket teeth							
	9	10	11**	12	23T	25T	27T	28T	30T	32T*	34T	36T
WH-R9270-C60	-	-	-	✓	-	-	-	-	-	CP-WR92C		-
WH-R9270-C50 WH-R9270-C36	-	-	-	✓	-	-	-	-	-	CP-WR92A		-
WH-R9200-C60 WH-R9200-C50 WH-R9200-C36	-	-	-	✓	-	-	-	-	-	CP-W124		-
WH-R8170-C60 WH-R8170-C50 WH-R8170-C36	-	-	✓	✓	-	-	-	-	-	CP-WR81A		-
WH-RS710-C32 WH-RS710-C46	-	-	✓	✓	-	-	-	-	-	CP-WH24		CP-WR71A
WH-R9170-C40	-	✓	✓	-	-	-	-	-	CP-W1460		-	-
WH-R9100-C40	-	✓	✓	-	-	-	-	-	CP-W124		-	-
WH-R9100-C24	-	-	✓	-	CP-WH23	-	-	-	CP-W120		-	-
	-	✓	-	-	-	-	-	-	CP-W020		-	-
WH-RS770-C30	-	-	✓	-	-	-	-	-	CP-W1460		CP-W1460	-
	-	✓	-	-	-	-	-	-	CP-W1460		-	-
WH-RS700-C30	-	-	✓	-	-	-	-	-	CP-W124		CP-W124	-
	-	✓	-	-	-	-	-	-	CP-W124		-	-
WH-RS500 WH-RS300 WH-RS11	-	-	✓	-	CP-WH23			-	CP-W120	-	-	-
WH-RS11	-	✓	-	-	CP-W020				-	-	-	-
WH-9000-C24-TU WH-RS330-CL	-	-	✓	-	CP-W184			-	CP-W124	-	-	-
WH-RS330-CL	-	✓	-	-	CP-W024				-	-	-	-
WH-RX830	-	✓	✓	-	-	-	-	CP-W1220		CP-WH14 CP-WH14A	-	-
WH-RX180 (HG spline L)	-	-	✓	✓	-	-	-	-	-	CP-WH30	CP-WR18A	-
WH-RX31	-	✓	✓	-	-	-	-	CP-W122				-
WH-RS100	-	✓	✓	-	-	-	-	CP-WH24		CP-FH53	-	-
WH-RS010-CL	-	✓	✓	-	-	-	-	CP-WH24		CP-FH53	-	-
WH-R501 WH-R501-A	✓	✓	-	-	CP-FH06	CP-FH31	CP-FH46	CP-WH24	-	-	-	-
WH-RS170	-	-	✓	-	CP-FH08	-	-	CP-WH12	-	-	-	-
	-	✓	-	-	CP-FH40 CP-FH41	CP-FH40 CP-FH41	CP-WH12	CP-WH12	CP-WH12	-	-	-
WH-RS171 (700c/650b)	-	-	✓	-	CP-FH08	-	-	CP-WH12	-	-	-	-
	-	✓	-	-	CP-FH40 CP-FH41	CP-FH40 CP-FH41	CP-WH12	CP-WH12	CP-WH12	-	-	-
WH-RX010-CL	-	-	✓	-	CP-FH08	-	-	CP-WH12	-	-	-	-
	-	✓	-	-	CP-FH40 CP-FH41	CP-FH40 CP-FH41	CP-WH12	CP-WH12	CP-WH12	-	-	-
WH-RX010	✓	✓	-	-	CP-FH08	CP-FH40 CP-FH41	CP-WH12	-	-	-	-	-
WH-U5000	-	✓	✓	-	-	-	CP-W122		-	-	-	-
WH-RS370	-	✓	✓	-	-	-	CP-WH12		-	-	-	-
	-	✓	-	-	CP-WH41			CP-WH12	-	-	-	
WH-RX880 (HG spline L2)	-	-	-	✓	-	-	-	-	-	CP-WRX8A		-
WH-RX870	-	-	✓	✓	-	-	-	-	-	CP-WH30	-	-
WH-RX570	-	✓	✓	-	-	-	CP-WH30			-	-	-
	-	✓	-	-	CP-WH41				CP-WH12	-	-	-

\* For compact crank set

\*\* 11-speed: CS-R9100 / CS-R8000 / CS-R7000 / CS-6800 / CS-5800

## Spoke protector for Road

Speed	Model No.	Number of largest sprocket teeth										Spoke holes number			
		21T	23T	24T	25T	26T	27T	28T	30T	32T	34T	24H	28H	32H	36H
8, 9, 10	Road	✓	✓	-	✓	-	-	-	-	-	-	CP-FH06	CP-FH08	CP-FH05	CP-FH06
		-	-	-	-	✓	-	-	-	-	-	CP-FH31	CP-FH08	CP-FH35	CP-FH31
		-	-	-	-	-	✓	✓	-	-	-	CP-FH31	CP-FH08	CP-FH35	CP-FH31
		-	-	-	-	-	-	-	✓	-	-	-	-	CP-FH45	CP-FH46
7	CS-HG400-7	-	-	-	-	-	-	✓	-	-	-	-	-	-	-
	CS-HG210-7	-	-	-	-	-	-	✓	-	-	-	-	-	-	-
	CS-HG200-7	-	-	-	-	-	-	✓	-	-	-	-	CP-FH35	CP-FH50	
	MF-TZ500-7 MF-TZ510-7 MF-TZ21	-	-	-	-	-	-	✓	-	-	-	-	-	CP-FH22/ MF-TZ500-7*/ MF-TZ21*	

Spoke protector is not available for Road 11-speed FREEHUB.

\* w/ Spoke protector spec. is available

## Compatibility chart of E-TUBE PROJECT Cyclist/Professional v5.4.4

### 2nd generation (Gen.2) battery management system

C-525

This is a compatibility table when using the following batteries.

- SHIMANO E-BIKE SYSTEMS Gen.2 battery
- Battery with hardware and firmware compatible with Gen.2 made by partner manufacturers.

\* Gen.2 battery management system is not compatible with a battery with hardware and firmware compatible with conventional system made by partner manufacturers.

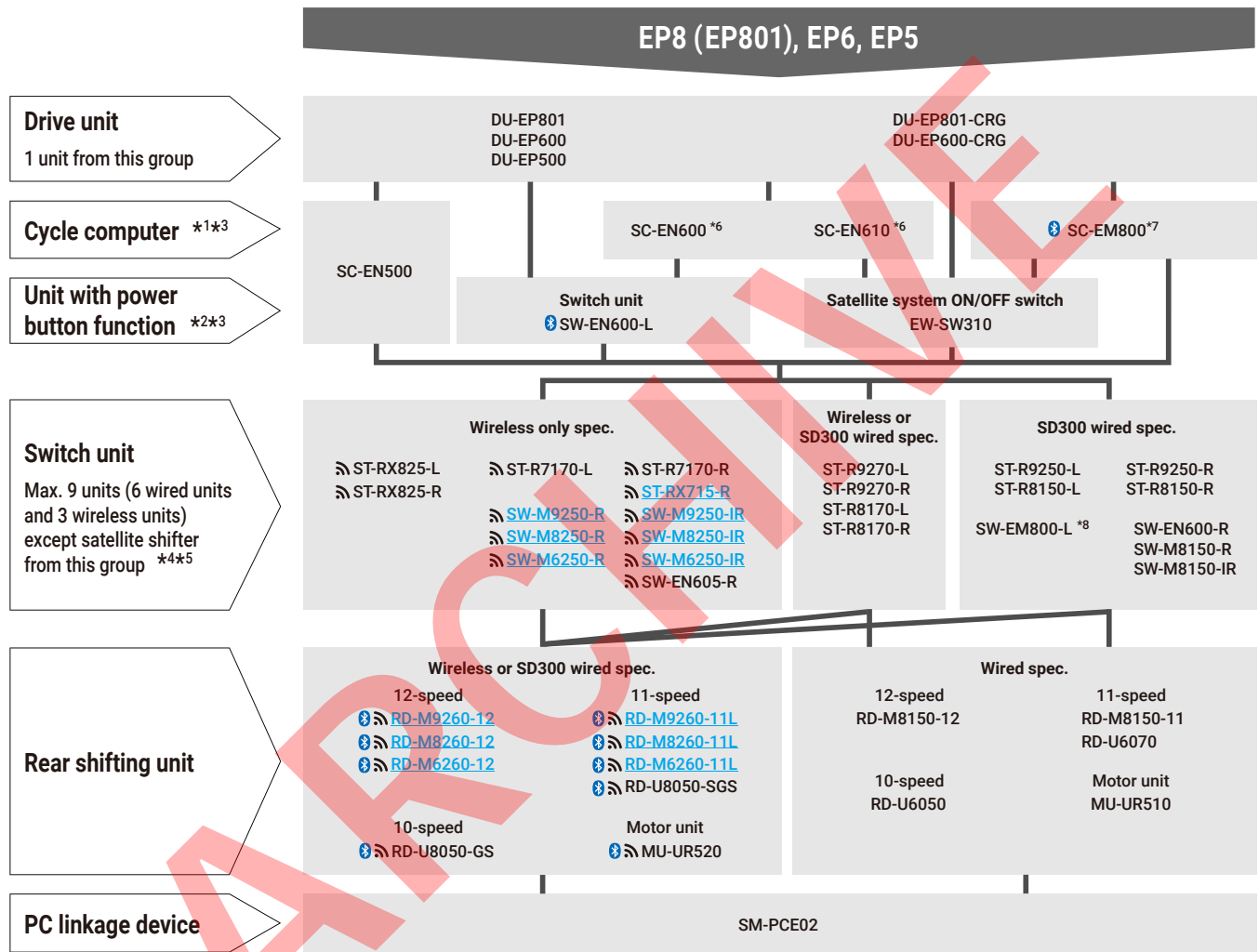

### Limitation of function

- \*1 When system has unit with power button function, cycle computer isn't mandatory.
- \*2 When the cycle computer, switch unit, and other units has power ON / OFF function, the unit with power button function isn't mandatory.
- \*3 When system has 3rd party CAN cycle computer, SHIMANO cycle computer and the unit with power button function isn't mandatory.
- \*4 Switch units are defined by model no. [SW], [ST], and [EW-SW] in this chart.
- \*5 The number of connectable wireless units paired by App is limited as follows:
  - DUAL CONTROL LEVER: ST-R max. one unit, ST-L max. one unit
  - Switch unit: maximum of one SW-R/IR
- \*6 Switch unit is mandatory for assist control.
- \*7 When drive unit (US Class 3) is connected, cycle computer can displays main screen (speed and assist bar) only.
- \*8 Need to change switch setting by E-TUBE PROJECT to use as shift switch.

# 1st generation battery management system for partner manufacturers' battery

\* This is a compatibility table when using a battery made by a partner manufacturer that ensures compatibility only by updating the firmware.

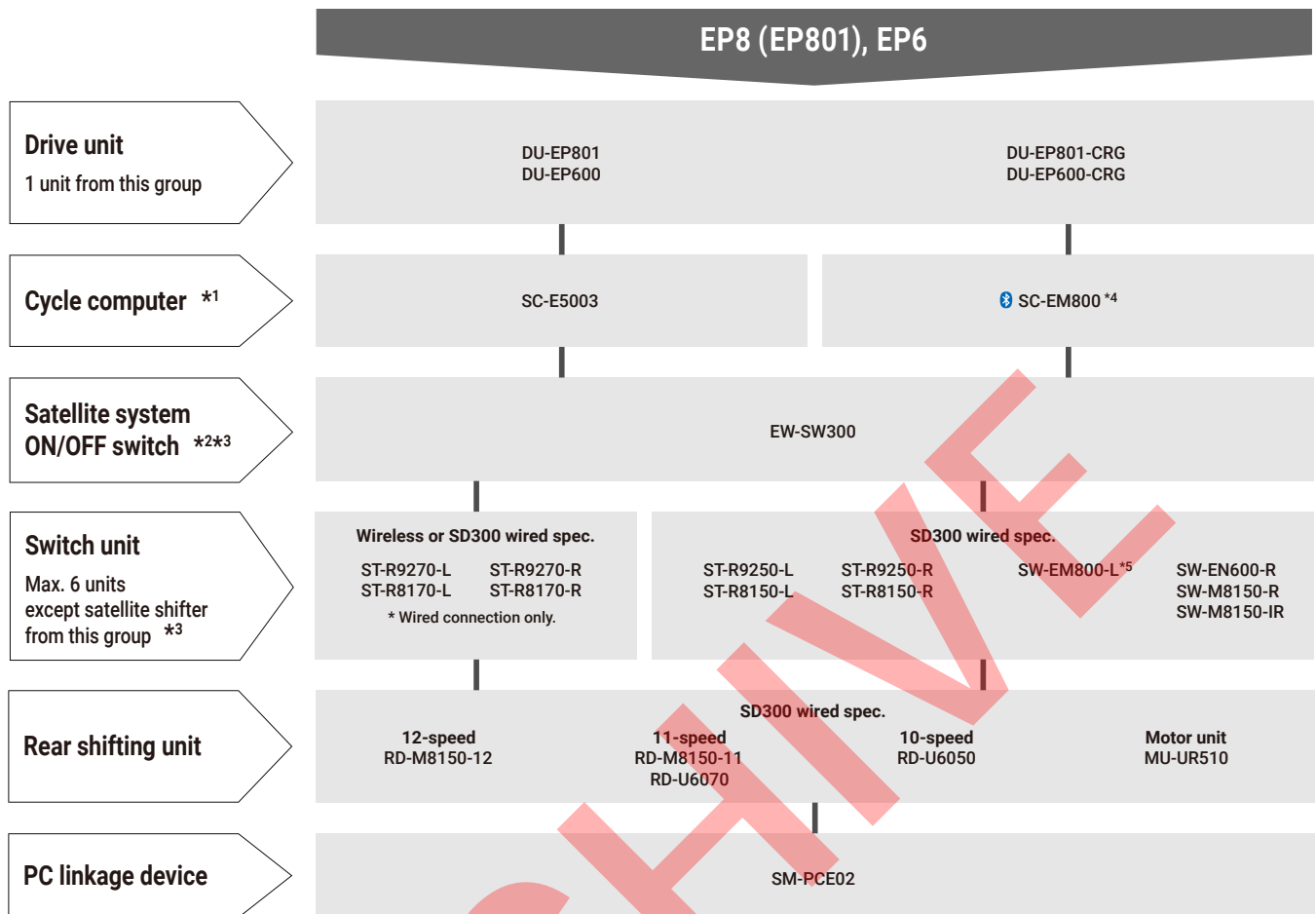

## Limitation of function

- \*1 Cycle computer is mandatory.
- \*2 When power on/off function on other unit, satellite power on/off switch isn't mandatory.
- \*3 Switch units are defined by model no. [SW], [ST], and [EW-SW] in this chart.
- \*4 When drive unit (US Class 3) is connected, cycle computer can displays main screen (speed and assist bar) only.
- \*5 Need to change switch setting by E-TUBE PROJECT to use as shift switch.

## 1st generation battery management system

\* This is a compatibility table when using the following batteries.

- SHIMANO E-BIKE SYSTEMS 1st generation battery
- Battery with hardware and firmware compatible with conventional system made by partner manufacturers.

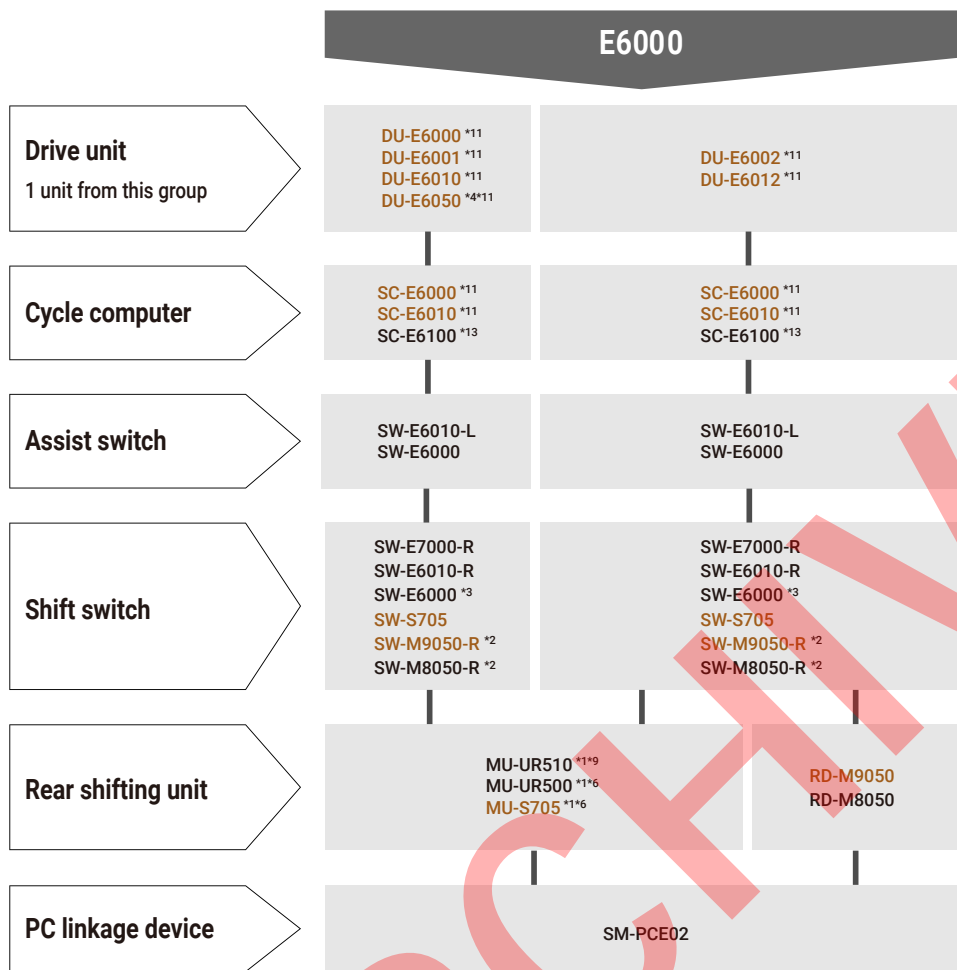

# E8000/E8080

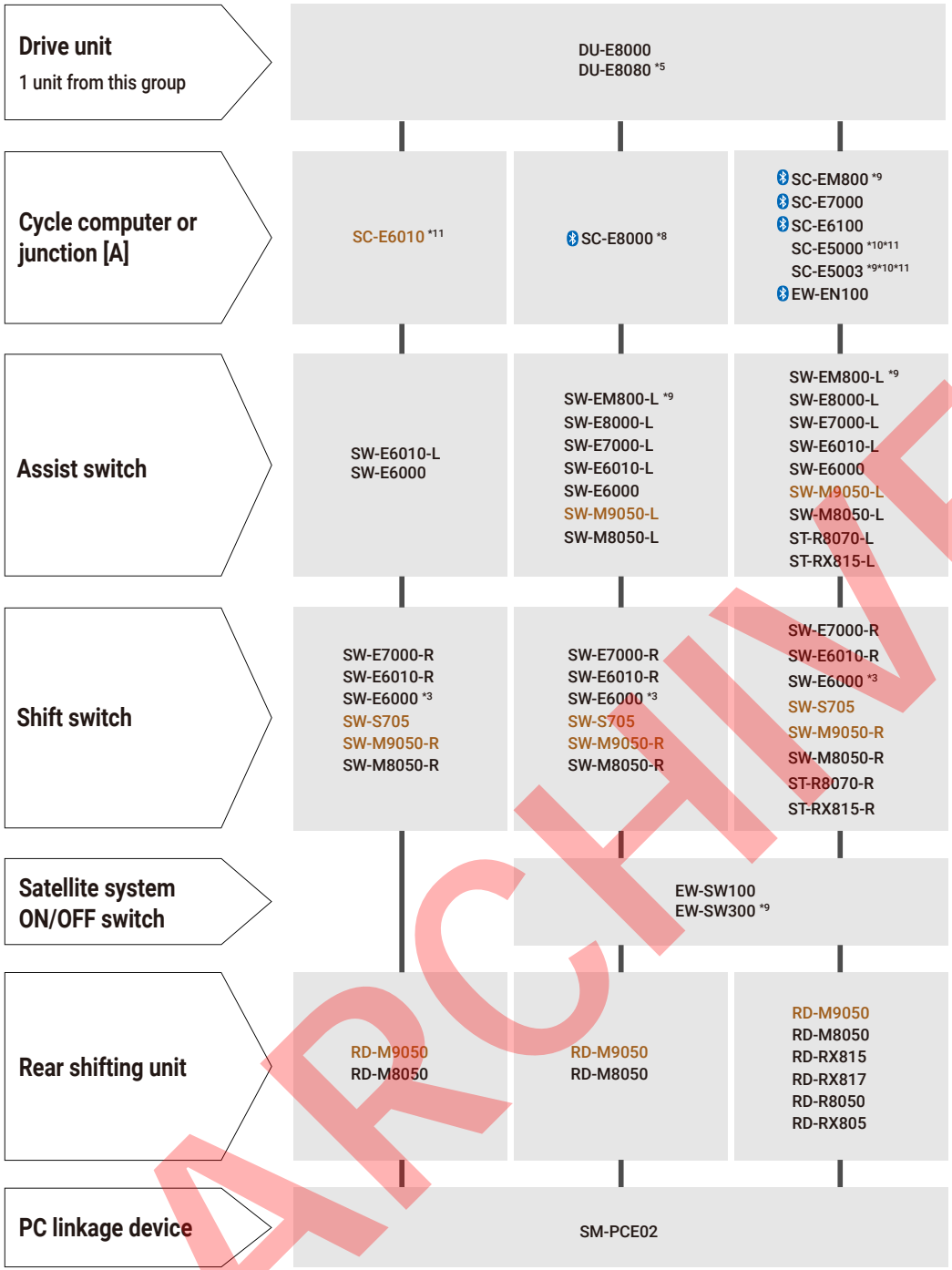

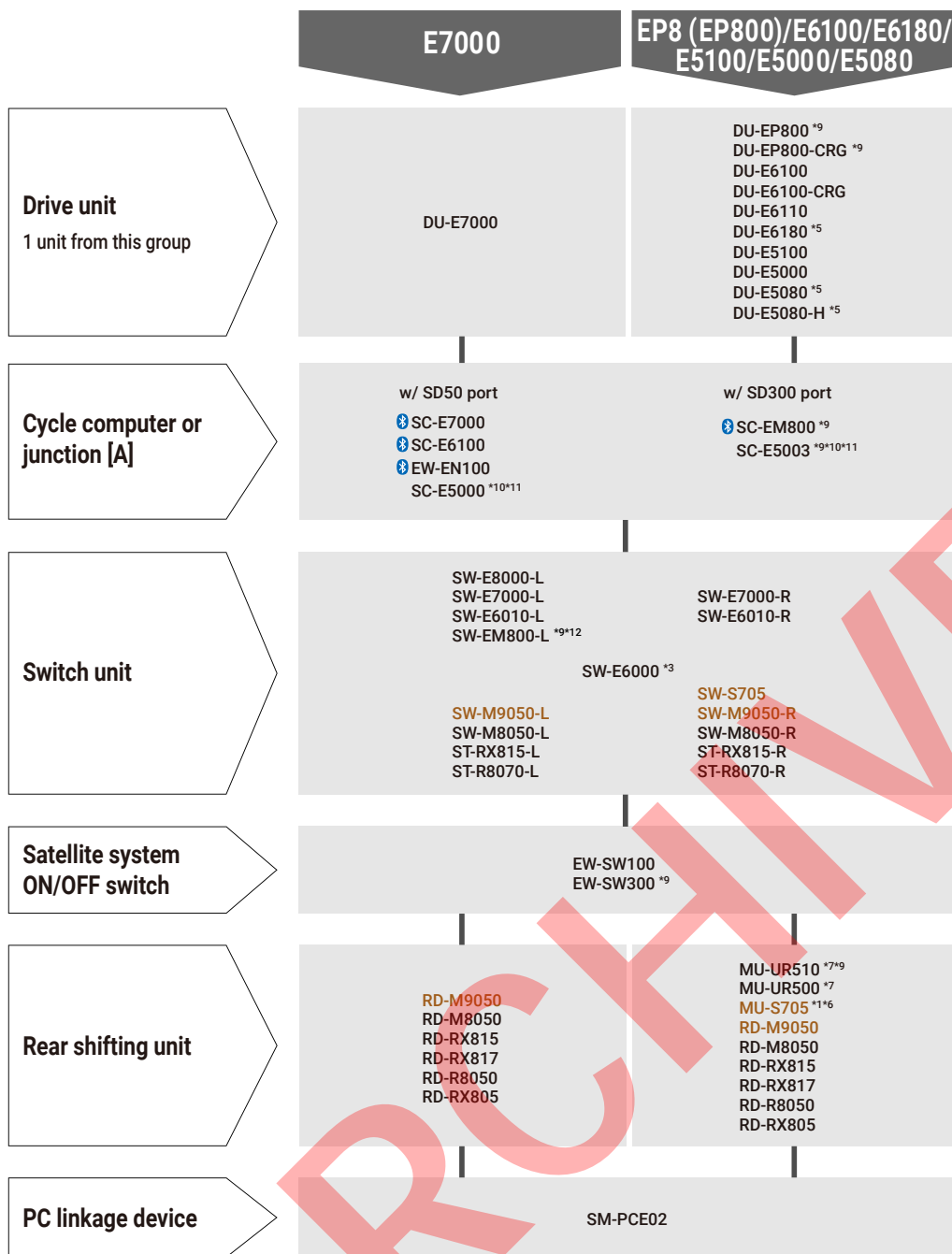

### Limitation of function

- \*1 Automatic gear shifting is available only with 8-speed internal geared hubs (Not available with rear derailleurs).
- \*2 Not support automatic shift.
- \*3 Need to change switch setting by E-TUBE PROJECT.
- \*4 North American market only.
- \*5 Japanese market only.
- \*6 Available only with 11-speed and 8-speed internal geared hubs.
- \*7 Automatic gear shifting is available only with 8 speed and 5 speed internal geared hub system. (Not available with Rear Derailleur)
- \*8 Not available in Japan market.
- \*9 This unit has SD300 port, and needs EW-AD305 for connection with SD50 port unit.
- \*10 SC-E5000, SC-E5003 is only for ø22.2 handlebar. Drop handlebar is unavailable.
- \*11 Not supported by E-TUBE PROJECT Cyclist.
- \*12 To use as a shift switch, the switch settings need to be changed in E-TUBE PROJECT.
- \*13 To use SC-E6100, firmware version need to be updated 4.2.0 or later.

## DU-EP801 / DU-EP801-CRG / DU-EP800 / DU-EP800-CRG / DU-EP600 / DU-EP600-CRG / DU-EP500 C-706

### 12-speed Rear derailleur spec.

Shifting system	Chain type	Rear sprocket	Crank arm	Chainring	Chain line (mm)	Chain guard	Chain device
HYPERGLIDE+ 12-speed *3 (Di2, Mechanical)	HG 12-speed	HYPERGLIDE+ 12-speed *2	FC-EM900 FC-M8150 FC-EM600 FC-EN500	SM-CRE80-12-SB 34T/36T	56.5	-	CD-EM800
				CR-EM800 *1*4 32T	55	-	CD-EM800 w/o plate
				SM-CRE80-12-B 34T/36T/38T			CD-EM800 (Chain line: 55 mm)
				SM-CRE70-12-B 36T	53	-	CD-EM800 SM-CDE80 SM-CDE70
				SM-CRE80-12-B 34T/36T/38T			
				SM-CRE70-12-B 36T	50	-	-
				SM-CRE80-R 47T			Double
				SM-CRE70-12 42T			

\*1 For DU-EP800 and DU-EP800-CRG, it is necessary to replace the lock ring to Y7K79801T

\*2 Do not use 9-45T cassette for E-BIKE

\*3 DU-EP800 and DU-EP800-CRG are not compatible with 12-speed Di2 drivetrain

\*4 If the drivetrain includes the CR-EM800 32T, optimal shifting performance may not be attainable at high torque level

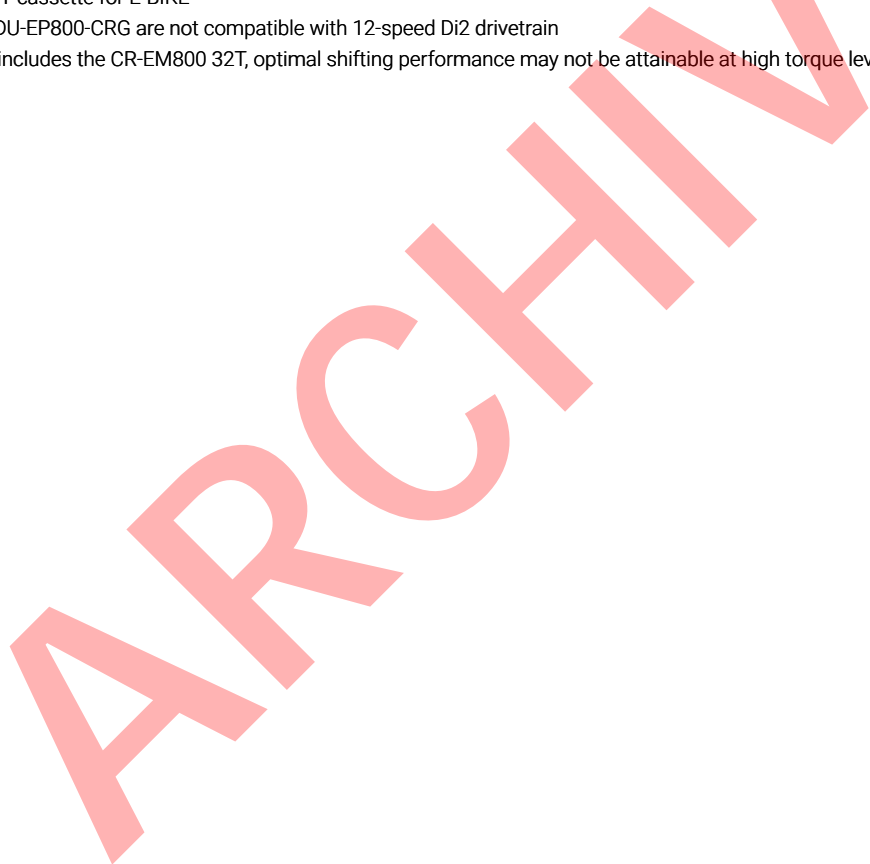

11/10/9-speed Rear derailleur spec.

Shifting system	Chain type	Rear sprocket	Crank arm	Chainring	Chain line (mm)	Chain guard	Chain device
LINKGLIDE *1 (Di2, Mechanical)	LINKGLIDE HG 11-speed	LINKGLIDE 11/10/9-speed	FC-EM900 FC-M8150 FC-EM600 FC-EN500	SM-CRE80-B 34T/38T	55	-	CD-EM800 (Chain line: 55 mm)
				SM-CRE70-B 34T			
				SM-CRE80-B 34T/38T	53	-	CD-EM800 SM-CDE80 SM-CDE70
				SM-CRE70-B 34T			
				CR-ET600 38T/44T	50	Double	-
				SM-CRE80 34T/38T	50	-	SM-CDE80 w/o plate
				SM-CRE80 44T	50	Double	-
				SM-CRE80-R 47T	50	-	-
				SM-CRE70 38T	50	-	SM-CDE80 w/o plate
	50	Double	-				
HG 11-speed (Di2, Mechanical)	LINKGLIDE HG 11-speed	HG 11-speed	FC-EM900 FC-M8150 FC-EM600 FC-EN500	SM-CRE80-B 34T/38T	55	-	CD-EM800 (Chain line: 55 mm)
				SM-CRE70-B 34T			
				SM-CRE80-B 34T/38T	53	-	CD-EM800 SM-CDE80 SM-CDE70
				SM-CRE70-B 34T			
				CR-ET600 38T/44T	50	Double	-
				SM-CRE80 34T/38T	50	-	SM-CDE80 w/o plate
				SM-CRE80 44T	50	Double	-
				SM-CRE80-R 47T	50	-	-
				SM-CRE70 38T	50	-	SM-CDE80 w/o plate
	50	Double	-				
HG 10-speed (Mechanical)	CN-E6090-10	HG 10-speed	FC-EM900 FC-M8150 FC-EM600 FC-EN500	SM-CRE80-B 34T/38T	55	-	CD-EM800 (Chain line: 55 mm)
				SM-CRE70-B 34T			
				SM-CRE80-B 34T/38T	53	-	CD-EM800 SM-CDE80 SM-CDE70
				SM-CRE70-B 34T			
				CR-ET600 38T/44T	50	Double	-
				SM-CRE80 34T/38T	50	-	SM-CDE80 w/o plate
				SM-CRE80 44T	50	Double	-
				SM-CRE80-R 47T	50	-	-
				SM-CRE70 38T	50	-	SM-CDE80 w/o plate
	50	Double	-				
HG 9-speed (Mechanical)	CN-E6070-9	HG 9-speed	FC-EM900 FC-M8150 FC-EM600 FC-EN500	SM-CRE70-B 34T	55	-	CD-EM800 (Chain line: 55 mm)
				SM-CRE70-B 34T	53		CD-EM800 SM-CDE80 SM-CDE70
				CR-ET600 38T/44T	50	Double	-
				SM-CRE80-R 47T	50	-	-
				SM-CRE70 38T	50	-	SM-CDE80 w/o plate
	50	Double	-				

\*1 DU-EP800 and DU-EP800-CRG are not compatible with LINKGLIDE Di2 drivetrain

## Internal geared hub spec.

Shifting system	Chain type	Rear sprocket	Crank arm	Chainring	Chain line (mm)	Chain guard	Chain tensioner
ALFINE INTER-11/8 (Di2, Mechanical)	CN-E6090-10 CN-E6070-9	CS-S500	FC-EM900 FC-M8150 FC-EM600 FC-EN500	CR-ET600 38T/44T	50	Double	CT-S510
				SM-CRE61 38T/44T	46.5		
	HG 8-speed	SM-GEAR		CR-ET600 38T/44T	50	Single	
				SM-CRE61 38T/44T	46.5		
				CR-ET600 38T/44T	50	w/o	
SM-CRE61 38T/44T	46.5						
NEXUS INTER-8 (Di2, Mechanical)	CN-E6090-10 CN-E6070-9	CS-S500	FC-EM900 FC-M8150 FC-EM600 FC-EN500	CR-ET600 38T/44T	50	Double	CT-S510
				SM-CRE61 38T/44T	46.5		
	HG 8-speed Single speed (1/2 inch x 1/8 inch)	SM-GEAR		CR-ET600 38T/44T	50	Single	
				SM-CRE61 38T/44T	46.5		
				CR-ET600 38T/44T	50	w/o	
SM-CRE61 38T/44T	46.5						
NEXUS INTER-7/3 (Mechanical)	CN-E6090-10 CN-E6070-9	CS-S500	FC-EM900 FC-M8150 FC-EM600 FC-EN500	CR-ET600 38T/44T	50	Double	CT-S510
				SM-CRE61 38T/44T	46.5		
	HG 8-speed Single speed (1/2 inch x 1/8 inch)	SM-GEAR		CR-ET600 38T/44T	50	Single	
				SM-CRE61 38T/44T	46.5		
				CR-ET600 38T/44T	50	w/o	
SM-CRE61 38T/44T	46.5						
NEXUS INTER-5E (Di2, Mechanical)	CN-E6070-9 CN-NX10	CS-C7000	FC-EM900 FC-M8150 FC-EM600 FC-EN500	CR-ET600 38T/44T	50	Double	CT-S510
				CR-ET600 38T/44T	50	Single	
				SM-CRE61 38T/44T	46.5		w/o
				CR-ET600 38T/44T	50		
				SM-CRE61 38T/44T	46.5		

## DU-E8000 / DU-E8080 / DU-E7000 C-656

### 12-speed Rear derailleur spec.

Shifting system	Chain type	Rear sprocket	Crank arm	Chainring	Chain line (mm)	Chain guard	Chain device		
HYPERGLIDE+ 12-speed (Mechanical)	HG 12-speed	HYPERGLIDE+ 12-speed *2	FC-M8050 FC-E8050 FC-E8000	SM-CRE80-12-SB 34T/36T	56.5	-	CD-EM800		
				CR-EM800 *1*3 32T	55	-	CD-EM800 w/o plate		
				SM-CRE80-12-B 34T/36T/38T			53	-	CD-EM800 (Chain line: 55 mm)
				SM-CRE70-12-B 36T	50	-			CD-EM800 SM-CDE80 SM-CDE70
				SM-CRE80-12-B 34T/36T/38T					
				SM-CRE70-12-B 36T	50	-	-		
				SM-CRE80-R 47T					
SM-CRE70-12 42T	50	Double	-						

\*1 Necessary to replace the lock ring to Y7K79801T

\*2 Do not use 9-45T cassette for E-BIKE

\*3 If the drivetrain includes the CR-EM800 32T, optimal shifting performance may not be attainable at high torque level

11/10/9-speed Rear derailleur spec.

Shifting system	Chain type	Rear sprocket	Crank arm	Chainring	Chain line (mm)	Chain guard	Chain device
LINKGLIDE (Mechanical)	LINKGLIDE	LINKGLIDE	FC-M8050 FC-E8050 FC-E8000	SM-CRE80-B 34T/38T	55	-	CD-EM800 (Chain line: 55 mm)
				SM-CRE70-B 34T			
				SM-CRE80-B 34T/38T	53	-	CD-EM800 SM-CDE80 SM-CDE70
				SM-CRE70-B 34T			
				CR-ET600 38T/44T	50	Double	-
				SM-CRE80 34T/38T		-	SM-CDE80 w/o plate
				SM-CRE80 44T		Double	-
				SM-CRE80-R 47T		-	SM-CDE80 w/o plate
				SM-CRE70 38T		-	-
						Double	-
HG 11-speed (Di2, Mechanical)	LINKGLIDE HG 11-speed	HG 11-speed	FC-M8050 FC-E8050 FC-E8000	SM-CRE80-B 34T/38T	55	-	CD-EM800 (Chain line: 55 mm)
				SM-CRE70-B 34T			
				SM-CRE80-B 34T/38T	53	-	CD-EM800 SM-CDE80 SM-CDE70
				SM-CRE70-B 34T			
				CR-ET600 38T/44T	50	Double	-
				SM-CRE80 34T/38T		-	SM-CDE80 w/o plate
				SM-CRE80 44T		Double	-
				SM-CRE80-R 47T		-	SM-CDE80 w/o plate
				SM-CRE70 38T		-	-
						Double	-
HG 10-speed (Mechanical)	CN-E6090-10	HG 10-speed	FC-M8050 FC-E8050 FC-E8000	SM-CRE80-B 34T/38T	55	-	CD-EM800 (Chain line: 55 mm)
				SM-CRE70-B 34T			
				SM-CRE80-B 34T/38T	53	-	CD-EM800 SM-CDE80 SM-CDE70
				SM-CRE70-B 34T			
				CR-ET600 38T/44T	50	Double	-
				SM-CRE80 34T/38T		-	SM-CDE80 w/o plate
				SM-CRE80 44T		Double	-
				SM-CRE80-R 47T		-	SM-CDE80 w/o plate
				SM-CRE70 38T		-	-
						Double	-
HG 9-speed (Mechanical)	CN-E6070-9	HG 9-speed	FC-M8050 FC-E8050 FC-E8000	SM-CRE70-B 34T	55	-	CD-EM800 (Chain line: 55 mm)
				SM-CRE70-B 34T	53		
				CR-ET600 38T/44T	50	Double	-
				SM-CRE80-R 47T	50	-	-
				SM-CRE70 38T	50	-	SM-CDE80 w/o plate
					50	Double	-

# DU-E6100 / DU-E6100-CRG / DU-E6110 / DU-E6180 C-657

## 12-speed Rear derailleur spec.

Shifting system	Chain type	Rear sprocket	Crank arm	Chainring	Chain line (mm)	Chain guard	Chain device
HYPERGLIDE+ 12-speed (Mechanical)	HG 12-speed	HYPERGLIDE+ 12-speed *1	FC-M8050 FC-E8050 FC-E8000 FC-E6100	SM-CRE80-12-SB 34T/36T	56.5	-	-
				SM-CRE80-12-B 34T/36T/38T	55	-	
				SM-CRE70-12-B 36T		-	
				SM-CRE80-12-B 34T/36T/38T	53	-	
				SM-CRE70-12-B 36T		-	
				SM-CRE80-R 47T	50	-	
				SM-CRE70-12 42T		Double	

\*1 Do not use 9-45T cassette for E-BIKE

## 11/10/9-speed Rear derailleur spec.

Shifting system	Chain type	Rear sprocket	Crank arm	Chainring	Chain line (mm)	Chain guard	Chain device
LINKGLIDE (Mechanical)	LINKGLIDE	LINKGLIDE	FC-M8050 FC-E8050 FC-E8000 FC-E6100	SM-CRE80-B 34T/38T	55	-	-
				SM-CRE70-B 34T		-	
				SM-CRE80-B 34T/38T	53	-	
				SM-CRE70-B 34T		-	
				CR-ET600 38T/44T	50	Double	
				SM-CRE80 34T/38T		-	
				SM-CRE80 44T		Double	
				SM-CRE80-R 47T		-	
				SM-CRE70 38T		-	
				SM-CRE70 38T		Double	
				SM-CRE61 38T/44T		46.5	
				HG 11-speed (Di2, Mechanical)	LINKGLIDE HG 11-speed	HG 11-speed	
SM-CRE70-B 34T	-						
SM-CRE80-B 34T/38T	53	-					
SM-CRE70-B 34T		-					
CR-ET600 38T/44T	50	Double					
SM-CRE80 34T/38T		-					
SM-CRE80 44T		Double					
SM-CRE80-R 47T		-					
SM-CRE70 38T		-					
SM-CRE70 38T		Double					
SM-CRE61 38T/44T		46.5	Double, Single, w/o				

Shifting system	Chain type	Rear sprocket	Crank arm	Chainring	Chain line (mm)	Chain guard	Chain device
HG 10-speed (Mechanical)	CN-E6090-10	HG 10-speed	FC-M8050 FC-E8050 FC-E8000 FC-E6100	SM-CRE80-B 34T/38T	55	-	-
				SM-CRE70-B 34T			
				SM-CRE80-B 34T/38T	53	-	
				SM-CRE70-B 34T			
				CR-ET600 38T/44T	50	Double	
				SM-CRE80 34T/38T		-	
				SM-CRE80 44T		Double	
				SM-CRE80-R 47T		-	
				SM-CRE70 38T		-	
				SM-CRE70 38T		Double	
				SM-CRE61 38T/44T		46.5	
HG 9-speed (Mechanical)	CN-E6070-9	HG 9-speed	FC-M8050 FC-E8050 FC-E8000 FC-E6100	SM-CRE80-B 34T/38T	55	-	-
				SM-CRE70-B 34T			
				SM-CRE80-B 34T/38T	53	-	
				SM-CRE70-B 34T			
				CR-ET600 38T/44T	50	Double	
				SM-CRE80 34T/38T		-	
				SM-CRE80 44T		Double	
				SM-CRE80-R 47T		-	
				SM-CRE70 38T		-	
				SM-CRE70 38T		Double	
				SM-CRE61 38T/44T		46.5	

ARCHIVE

Internal geared hub spec.

Shifting system	Chain type	Rear sprocket	Crank arm	Chainring	Chain line (mm)	Chain guard	Chain tensioner
ALFINE INTER-11/8 (Di2, Mechanical)	CN-E6090-10 CN-E6070-9	CS-S500	FC-M8050 FC-E8050 FC-E8000 FC-E6100	CR-ET600 38T/44T	50	Double	CT-S510
				SM-CRE61 38T/44T	46.5		
	HG 8-speed	SM-GEAR		CR-ET600 38T/44T	50	Single	
				SM-CRE61 38T/44T	46.5		
				CR-ET600 38T/44T	50	w/o	
SM-CRE61 38T/44T	46.5						
NEXUS INTER-8 (Di2, Mechanical)	CN-E6090-10 CN-E6070-9	CS-S500	FC-M8050 FC-E8050 FC-E8000 FC-E6100	CR-ET600 38T/44T	50	Double	CT-S510
				SM-CRE61 38T/44T	46.5		
	HG 8-speed Single speed (1/2 inch x 1/8 inch)	SM-GEAR		CR-ET600 38T/44T	50	Single	
				SM-CRE61 38T/44T	46.5		
				CR-ET600 38T/44T	50	w/o	
SM-CRE61 38T/44T	46.5						
NEXUS INTER-7/3 (Mechanical)	CN-E6090-10 CN-E6070-9	CS-S500	FC-M8050 FC-E8050 FC-E8000 FC-E6100	CR-ET600 38T/44T	50	Double	CT-S510
				SM-CRE61 38T/44T	46.5		
	HG 8-speed Single speed (1/2 inch x 1/8 inch)	SM-GEAR		CR-ET600 38T/44T	50	Single	
				SM-CRE61 38T/44T	46.5		
				CR-ET600 38T/44T	50	w/o	
SM-CRE61 38T/44T	46.5						
NEXUS INTER-5E (Di2, Mechanical)	CN-E6070-9 CN-NX10	CS-C7000	FC-M8050 FC-E8050 FC-E8000 FC-E6100	CR-ET600 38T/44T	50	Double	CT-S510
				CR-ET600 38T/44T	50	Single	
				SM-CRE61 38T/44T	46.5		
				CR-ET600 38T/44T	50	w/o	
				SM-CRE61 38T/44T	46.5		

ARCA

## DU-E6000 / DU-E6001 / DU-E6010 / DU-E6050 C-658

### 11/10/9-speed Rear derailleur spec.

Shifting system	Chain type	Rear sprocket	Crank arm	Chainring	Chain line (mm)	Chain guard	Chain tensioner
HG 11-speed (Mechanical)	HG 11-speed	HG 11-speed	FC-E6000 FC-E6010 FC-E5000 FC-E5010	SM-CRE60 38T/44T	46.5	Double	-
HG 10-speed (Mechanical)	CN-E6090-10	HG 10-speed		SM-CRE60 38T/44T	46.5	Double	-
HG 9-speed (Mechanical)	CN-E6070-9	HG 9-speed		SM-CRE60 38T/44T	46.5	Double	-

### Internal geared hub spec.

Shifting system	Chain type	Rear sprocket	Crank arm	Chainring	Chain line (mm)	Chain guard	Chain tensioner
ALFINE INTER-11/8 (Di2, Mechanical)	CN-E6070-9 HG 8-speed	CS-S500	FC-E6000 FC-E6010 FC-E5000 FC-E5010	SM-CRE60 38T/44T	46.5	w/o	CT-S510
		SM-GEAR			46.5	Double	
NEXUS INTER-8 (Di2, Mechanical)	HG Single speed (1/2 inch x 1/8 inch)	SM-GEAR		SM-CRE60 38T/44T	46.5	Single, w/o	CT-S510 *
NEXUS INTER-7/3 (Mechanical)	HG Single speed (1/2 inch x 1/8 inch)	SM-GEAR	SM-CRE60 38T/44T	46.5	Single, w/o		

\* Not compatible with CN-NX10

## DU-E5100 / DU-E5000 / DU-E5080 / DU-E5080-H C-659

### 11/10/9-speed Rear derailleur spec.

Shifting system	Chain type	Rear sprocket	Crank arm	Chainring	Chain line (mm)	Chain guard	Chain device
LINKGLIDE (Mechanical)	LINKGLIDE	LINKGLIDE	FC-E6000 FC-E6010 FC-E5000 FC-E5010	SM-CRE50 38T/44T	46.5	Double, Single, w/o	-
HG 11-speed (Di2, Mechanical)	HG 11-speed	HG 11-speed		SM-CRE50 38T/44T	46.5	Double, Single, w/o	
HG 10-speed (Mechanical)	CN-E6090-10	HG 10-speed		SM-CRE50 38T/44T	46.5	Double, Single, w/o	
HG 9-speed (Mechanical)	CN-E6070-9	HG 9-speed		SM-CRE50 38T/44T	46.5	Double, Single, w/o	

### Internal geared hub spec.

Shifting system	Chain type	Rear sprocket	Crank arm	Chainring	Chain line (mm)	Chain guard	Chain device
ALFINE INTER-11/8 (Di2, Mechanical)	CN-E6090-10 CN-E6070-9	CS-S500	FC-E6000 FC-E6010 FC-E5000 FC-E5010	SM-CRE50 38T/44T	46.5	Double	CT-S510
	HG 8-speed	SM-GEAR		SM-CRE50 38T/44T		Single	
				SM-CRE50 38T/44T		w/o	-
NEXUS INTER-8 (Di2, Mechanical)	CN-E6090-10 CN-E6070-9	CS-S500		SM-CRE50 38T/44T	46.5	Double	CT-S510
	HG 8-speed Single speed (1/2 inch x 1/8 inch)	SM-GEAR		SM-CRE50 38T/44T		Single	
				SM-CRE50 38T/44T		w/o	-
NEXUS INTER-7/3 (Mechanical)	CN-E6090-10 CN-E6070-9	CS-S500		SM-CRE50 38T/44T	46.5	Double	CT-S510
	HG Single speed (1/2 inch x 1/8 inch)	SM-GEAR		SM-CRE50 38T/44T		Single	
			SM-CRE50 38T/44T	w/o		-	
NEXUS INTER-5E (Di2, Mechanical)	HG 8-speed CN-NX10	CS-C7000	SM-CRE50 38T/44T	46.5	Single, w/o	-	

# Switch unit / cycle computer and brake lever compatibility

## For Hydraulic Disc brake

For MTB Di2 shift switch, refer to [C-744](#)

### I-SPEC EV type brake lever

Model No.	SHIMANO E-BIKE SYSTEMS cycle computer		
	SC-EN500 *1	SC-E5000 *1	SC-E5003 *1
<a href="#">BL-M9200</a>	✓	✓	✓
<a href="#">BL-M9220</a>	✓	✓	✓
BL-M9100	✓	✓	-
BL-M9120	✓	✓	-
<a href="#">BL-M8200</a>	✓	✓	✓
BL-M8100	✓	✓	-
BL-M7100	✓	✓	-
BL-M6100	✓	✓	-
BL-M4100	✓	✓	-

Model No.	SHIMANO E-BIKE SYSTEMS switch unit							
	SW-EM800-L	SW-EN600-L	SW-EN600-R	SW-E8000-L	SW-E7000	SW-E6010	SW-E6000	SW-EN605-R
<a href="#">BL-M9200</a>	✓	✓	✓	-	✓	✓	✓	✓
<a href="#">BL-M9220</a>	✓	✓	✓	-	✓	✓	✓	✓
BL-M9100	✓	✓	✓	-	✓	✓	✓	✓
BL-M9120	✓	✓	✓	-	✓	✓	✓	✓
<a href="#">BL-M8200</a>	✓	✓	✓	-	✓	✓	✓	✓
BL-M8100	✓	✓	✓	-	✓	✓	✓	✓
BL-M7100	✓	✓	✓	-	✓	✓	✓	✓
BL-M6100	✓	✓	✓	-	✓	✓	✓	✓
BL-M4100	✓	✓	✓	-	✓	✓	✓	✓

\*1 I-SPEC EV compatible spec only.

### I-SPEC II type brake lever

Model No.	SHIMANO E-BIKE SYSTEMS cycle computer		
	SC-EN500	SC-E5000	SC-E5003
<a href="#">BL-M9000</a>	✓	✓	✓
<a href="#">BL-M9020</a>	✓	✓	✓
BL-M8000	✓	✓	✓
BL-T8100	✓	✓	✓
BL-T8000	✓	✓	✓
<a href="#">BL-M7000</a>	✓	✓	✓
<a href="#">BL-M6000</a>	✓	✓	✓
BL-T6000	✓	✓	✓
BL-RS600	✓	✓	✓
BL-MT501	✓	✓	✓
BL-U8000 *1	✓	✓	✓

Model No.	SHIMANO E-BIKE SYSTEMS switch unit							
	SW-EM800-L	SW-EN600-L	SW-EN600-R	SW-E8000-L	SW-E7000	SW-E6010	SW-E6000	SW-EN605-R
<a href="#">BL-M9000</a>	✓	✓	✓	✓	✓	✓	✓	✓
<a href="#">BL-M9020</a>	✓	✓	✓	✓	✓	✓	✓	✓
BL-M8000	✓	✓	✓	✓	✓	✓	✓	✓
BL-T8100	✓	✓	✓	✓	✓	✓	✓	✓
BL-T8000	✓	✓	✓	✓	✓	✓	✓	✓
<a href="#">BL-M7000</a>	✓	✓	✓	✓	✓	✓	✓	✓
<a href="#">BL-M6000</a>	✓	✓	✓	✓	✓	✓	✓	✓
BL-T6000	✓	✓	✓	✓	✓	✓	✓	✓
BL-RS600	✓	✓	✓	✓	✓	✓	✓	✓
BL-MT501	✓	✓	✓	✓	✓	✓	✓	✓
BL-U8000 *1	✓	✓	✓	-	✓	✓	✓	✓

\*1 As for the compatibility between BL-U8000 and mechanical shifter, please refer to the [C-738](#).

## Other clamp band type brake lever

Model No.	SHIMANO E-BIKE SYSTEMS cycle computer		
	SC-EN500	SC-E5000	SC-E5003
BL-MT402-3A	✓	✓	✓
BL-MT401	✓	✓	✓
BL-MT201	✓	✓	✓
BL-MT200	✓	✓	✓

Model No.	SHIMANO E-BIKE SYSTEMS switch unit							
	SW-EM800-L	SW-EN600-L	SW-EN600-R	SW-E8000-L	SW-E7000	SW-E6010	SW-E6000	SW-EN605-R
BL-MT402-3A	✓	✓	✓	✓	✓	✓	✓	✓
BL-MT401	✓	✓	✓	✓	✓	✓	✓	✓
BL-MT201	✓	✓	✓	✓	✓	✓	✓	✓
BL-MT200	✓	✓	✓	✓	✓	✓	✓	✓

## Brake lever for mechanical brake (Mechanical disc brake / V-BRAKE / Caliper brake / Cantilever brake)

Refer to Spec Hand Book for compatible brake type.

Model No.	SHIMANO E-BIKE SYSTEMS cycle computer		
	SC-EN500	SC-E5000	SC-E5003
BL-T610	✓	✓	✓
BL-T611	✓	✓	✓
BL-T4000	✓	✓	✓
BL-T4010	✓	✓	✓
BL-C6010	✓	✓	✓
BL-4700	✓	✓	✓
BL-R3000	✓	✓	✓
BL-R2000	✓	✓	✓
BL-R780	✓	✓	✓
BL-R550	✓	✓	✓

Model No.	SHIMANO E-BIKE SYSTEMS switch unit							
	SW-EM800-L	SW-EN600-L	SW-EN600-R	SW-E8000-L	SW-E7000	SW-E6010	SW-E6000	SW-EN605-R
BL-T610	✓	✓	✓	✓	✓	✓	✓	✓
BL-T611	✓	✓	✓	✓	✓	✓	✓	✓
BL-T4000	✓	✓	✓	✓	✓	✓	✓	✓
BL-T4010	✓	✓	✓	✓	✓	✓	✓	✓
BL-C6010	✓	✓	✓	✓	✓	✓	✓	✓
BL-4700	✓	✓	✓	✓	✓	✓	✓	✓
BL-R3000	✓	✓	✓	✓	✓	✓	✓	✓
BL-R2000	✓	✓	✓	✓	✓	✓	✓	✓
BL-R780	✓	✓	✓	✓	✓	✓	✓	✓
BL-R550	✓	✓	✓	✓	✓	✓	✓	✓

# Battery and battery mount compatibility

Batteries shipped in the country / region are different.

For Gen.2 battery management system

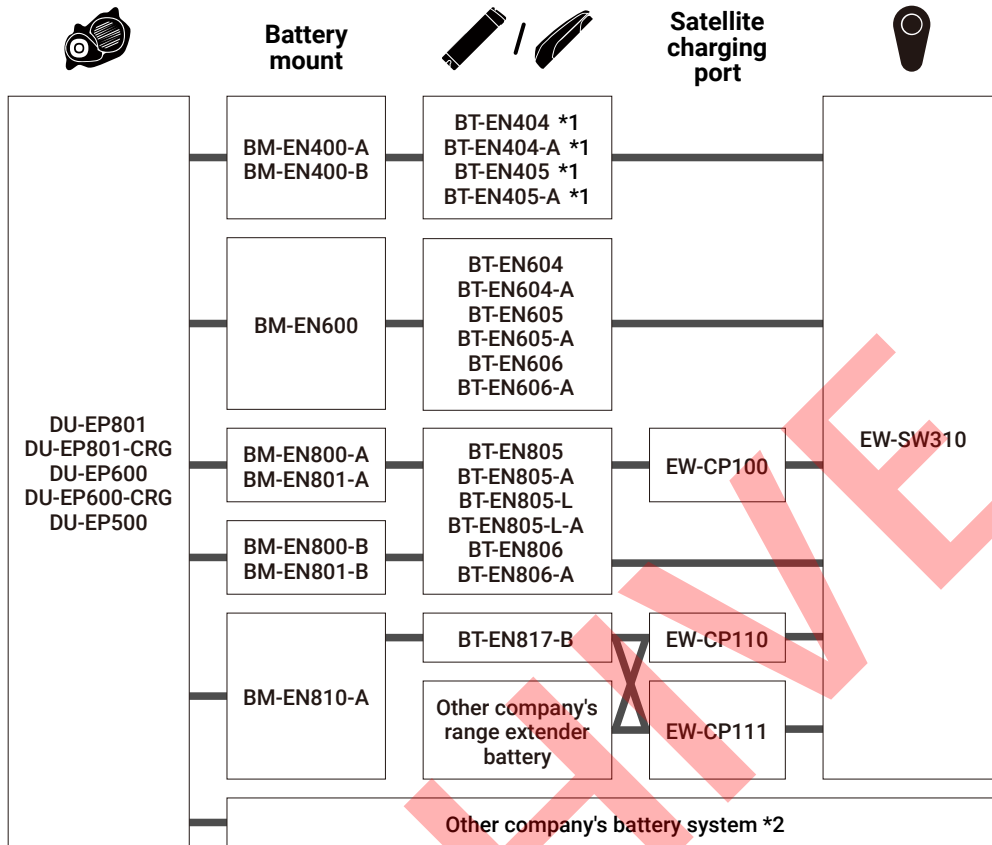

## Limitation of function

\*1 These batteries don't support over 500W drive unit power output

\*2 Some of these batteries don't support over 500W drive unit power output

For 1st generation battery management system

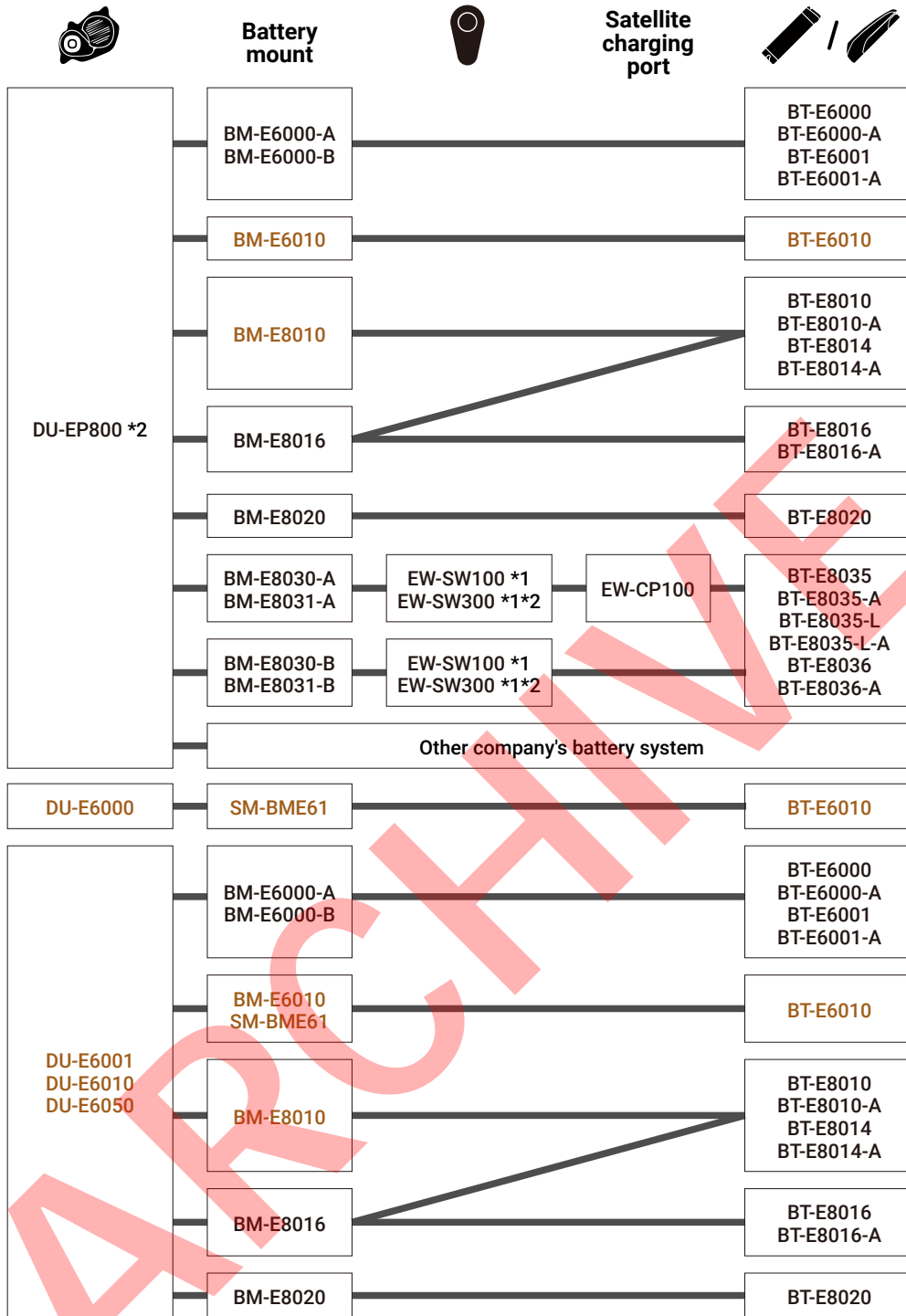

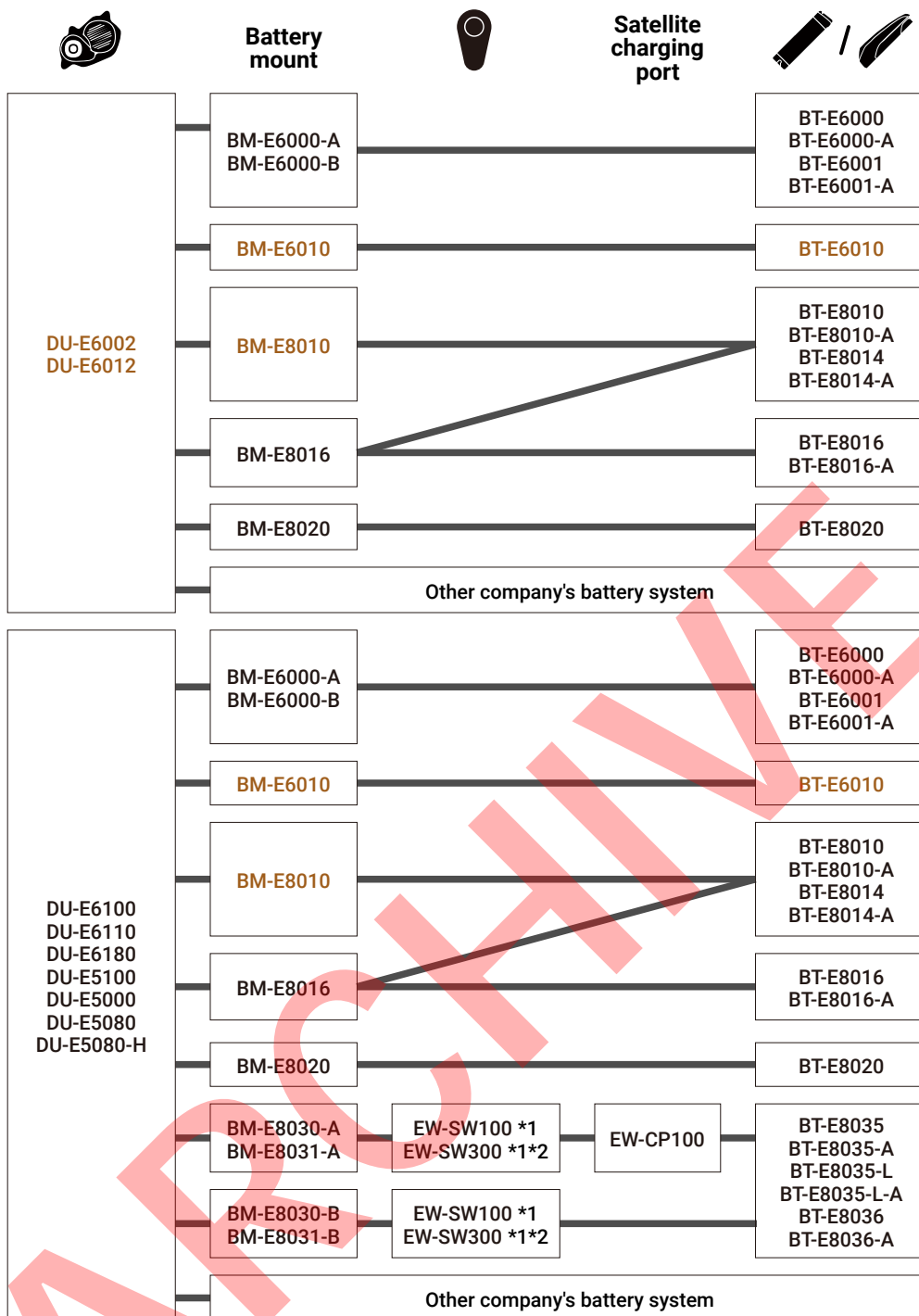

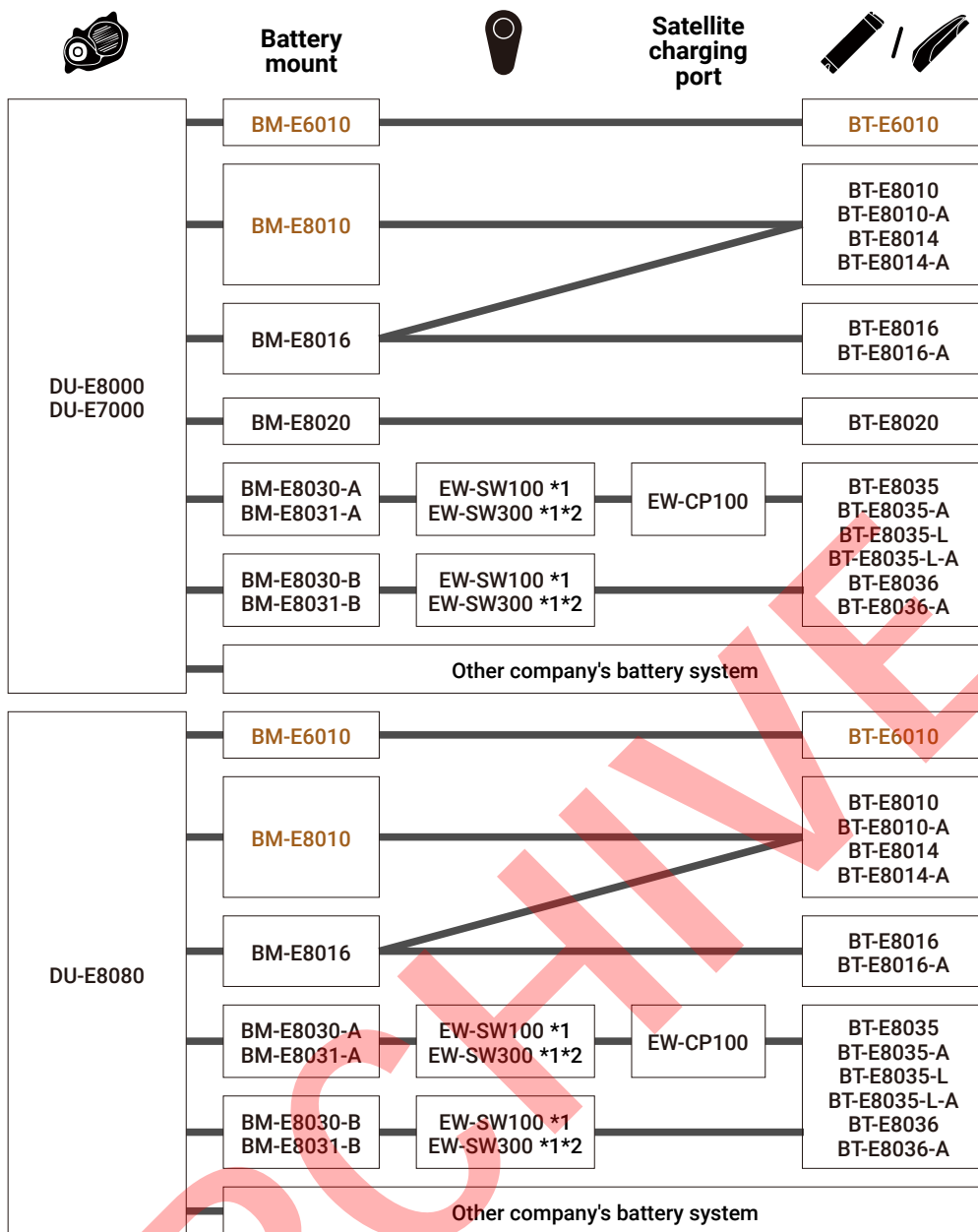

**Limitation of function**

\*1 Can't use with SC-E6010

\*2 This unit has SD300 port, and needs EW-AD305 for connection to SD50 port unit.

## Frame mount compatibility

### External battery type

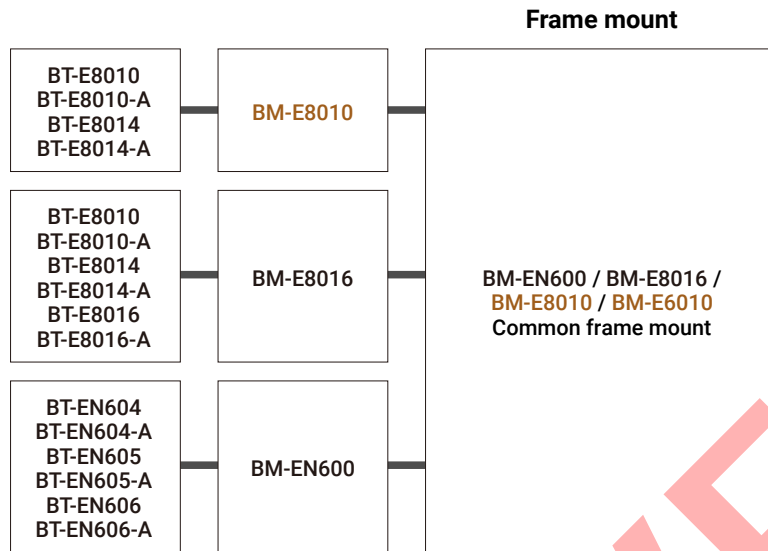

### Integrated battery type

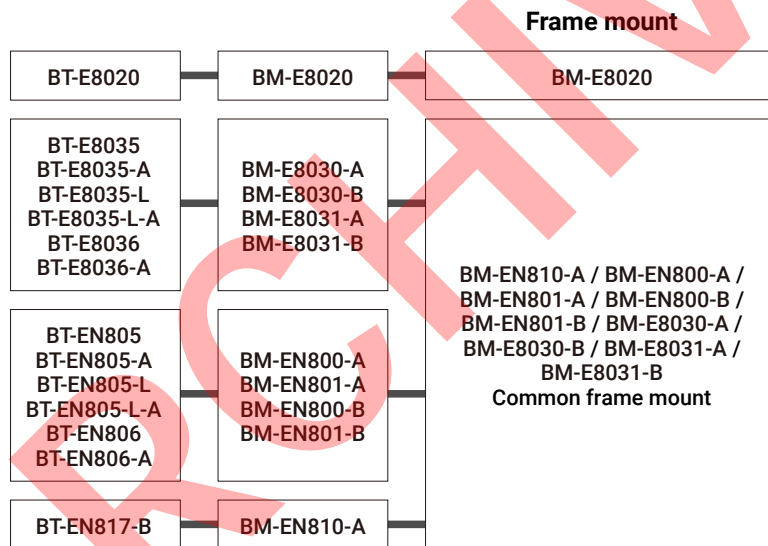

# System on/off function compatibility

 : Products marked with this icon have the main power ON/OFF function of the E-BIKE.

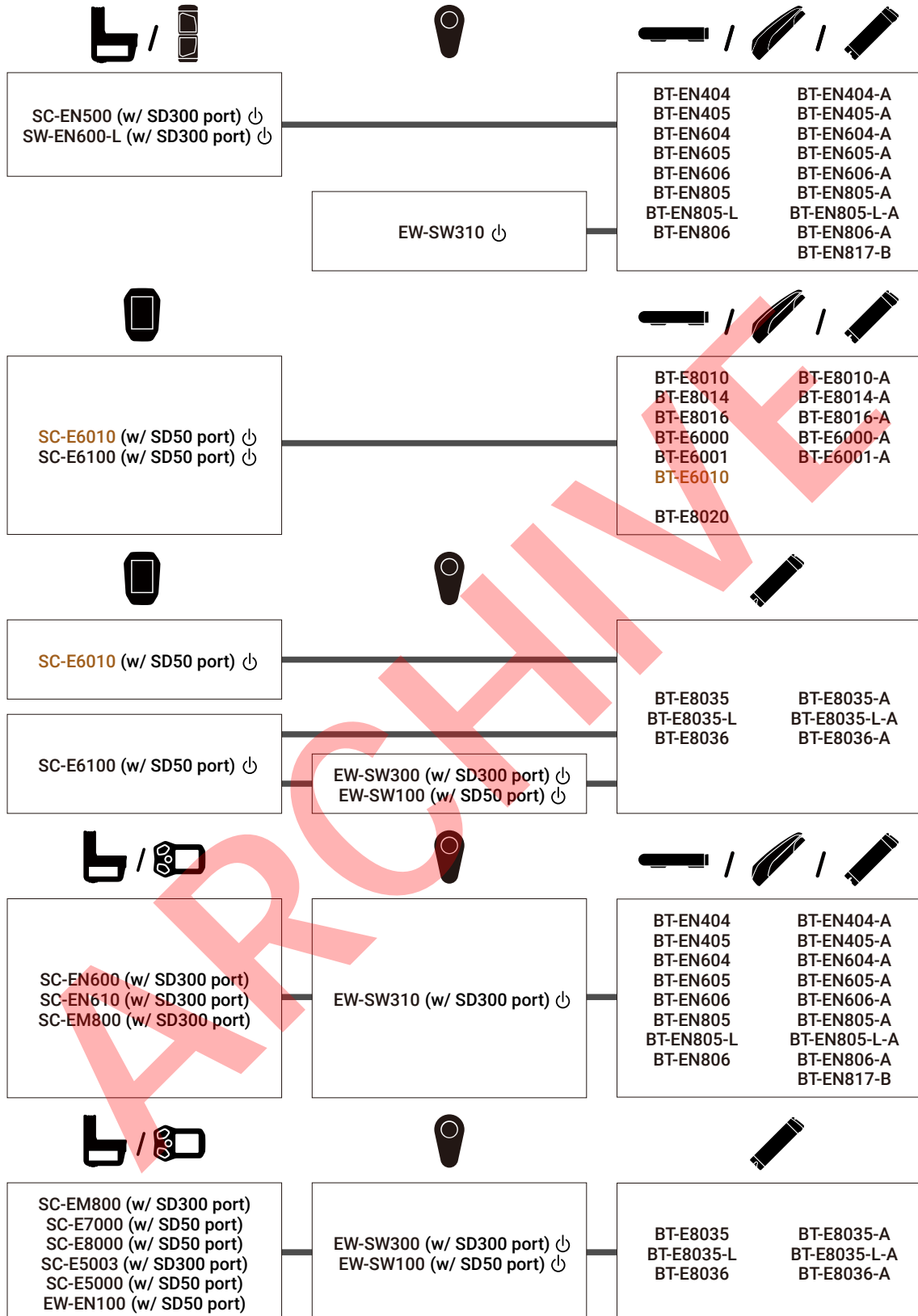

# Configuration of assist switch functions

3 buttons (exclude system ON/OFF) in E-BIKE system are necessary to operate full of e-bike functions.  
 If the system only have 1 or 2 buttons, functions to operate in the E-BIKE are limited as shown in the list.

Drive Unit	Cockpit item 1	Cockpit item 2	Cockpit item 3	Total number of switches in the E-BIKE	Configuration for switch function	Functions in customize menu
DU-EP801 DU-EP801-CRG DU-EP600 DU-EP600-CRG DU-EP500	SC-EN500	-	-	5	1: System ON/OFF 2: Assist up 3: Assist down 4: Display / Setting 5: Light ON/OFF	-
	SW-EN600-L	-	-	5	1: System ON/OFF 2: Assist up (**) 3: Assist down (**) 4: Display / Setting 5: - (**)	D-FLY Display / Setting Gear shifting mode Light ON/OFF
	SC-EN600 SC-EN610	SW-EN600-L	-	5	1: System ON/OFF 2: Assist up 3: Assist down 4: Display / Setting (**) 5: Light ON/OFF	D-FLY Display / Settings Gear shifting mode Light on/off
	SC-EN600 SC-EN610	EW-SW310	SW-EM800-L	4	1: System ON/OFF 2: Assist up (**) 3: Assist down (**) 4: Display / Setting (**)  * Light can be turned ON/OFF via cycle computer setting menu	Assist up Assist down Rear shift up Rear shift down D-FLY Display / Setting Gear shifting mode Light ON/OFF RD function
	SC-EM800	EW-SW310	SW-EM800-L	5	1: System ON/OFF 2: Assist up (**) 3: Assist down (**) 4: Display / Setting 5: Light ON/OFF (**)	Assist up Assist down Rear shift up Rear shift down D-FLY Display / Setting Gear shifting mode Light ON/OFF RD function
	SC-EM800	SW-EM800-L	-	3	1: Assist up (**) 2: Assist down (**) 3: Display / Setting  * Light can be turned ON/OFF via cycle computer setting menu * System can be turned ON/OFF via button on the battery	Assist up Assist down Rear shift up Rear shift down D-FLY Display / Setting Gear shifting mode Light ON/OFF RD function
	EW-SW310	-	-	2	1: System ON/OFF 2: Assist up (Cycle) (*, **)	D-FLY Display / Setting Gear shifting mode Light ON/OFF
	SC-EN600 SC-EN610	EW-SW310	-	2	1: System ON/OFF 2: Assist up (Cycle) (*, **)	D-FLY Display / Setting Gear shifting mode Light ON/OFF
	SC-EM800	EW-SW310	-	3	1: System ON/OFF 2: Assist up (Cycle) (*, **) 3: Display / Setting	D-FLY Display / Setting Gear shifting mode Light ON/OFF

\* Each time you press the switch, the mode changes to a mode with stronger assist power, and returns to OFF from mode of maximum assist power.

Example: OFF→ECO→TRAIL→BOOST→OFF

\*\* Function assignments to buttons can be customized.

## Speed sensor and drive unit compatibility

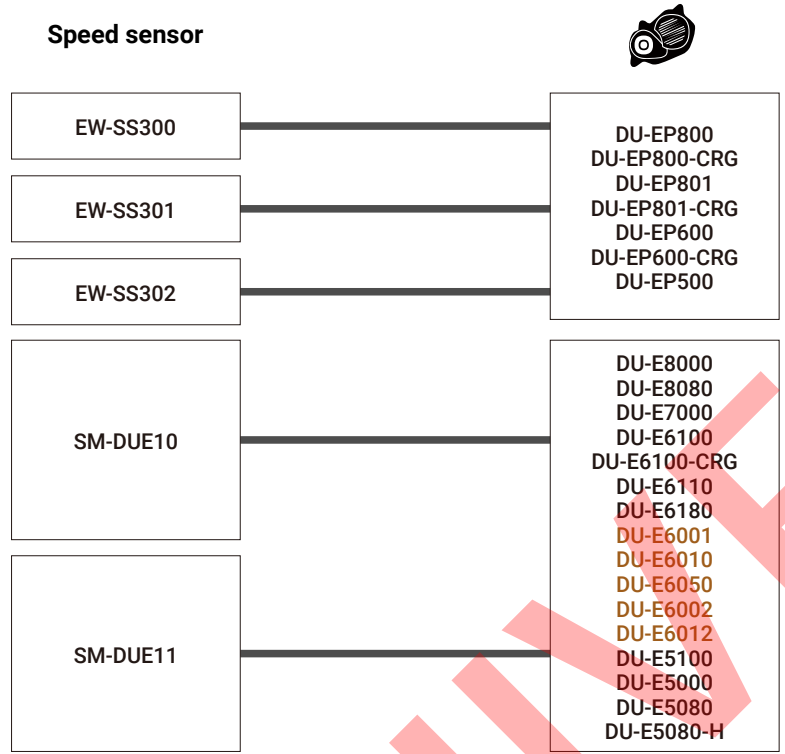

## Magnet adapter and rotor compatibility

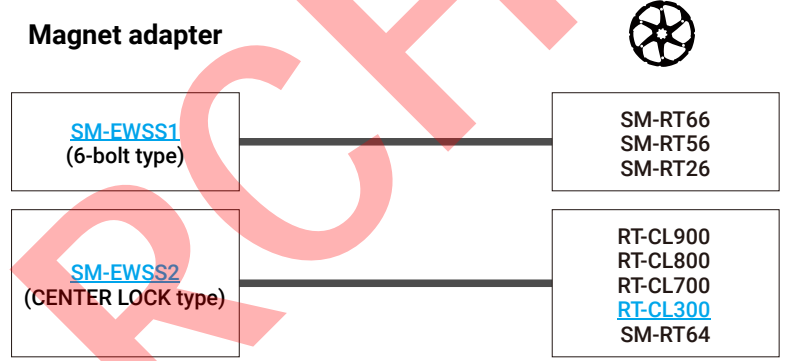

# Battery and battery charger compatibility

For BT-ENxxx-A/B and BT-Exxxx-A

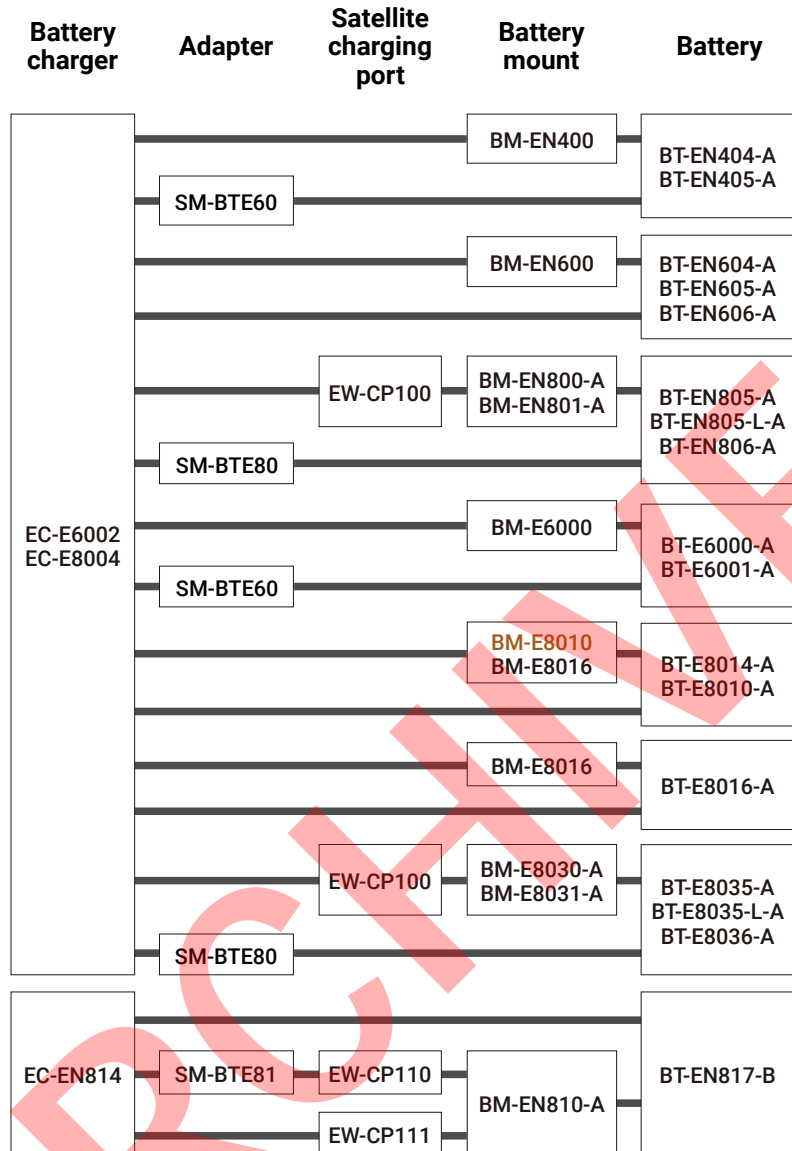

For BT-ENxxx and BT-Exxxx

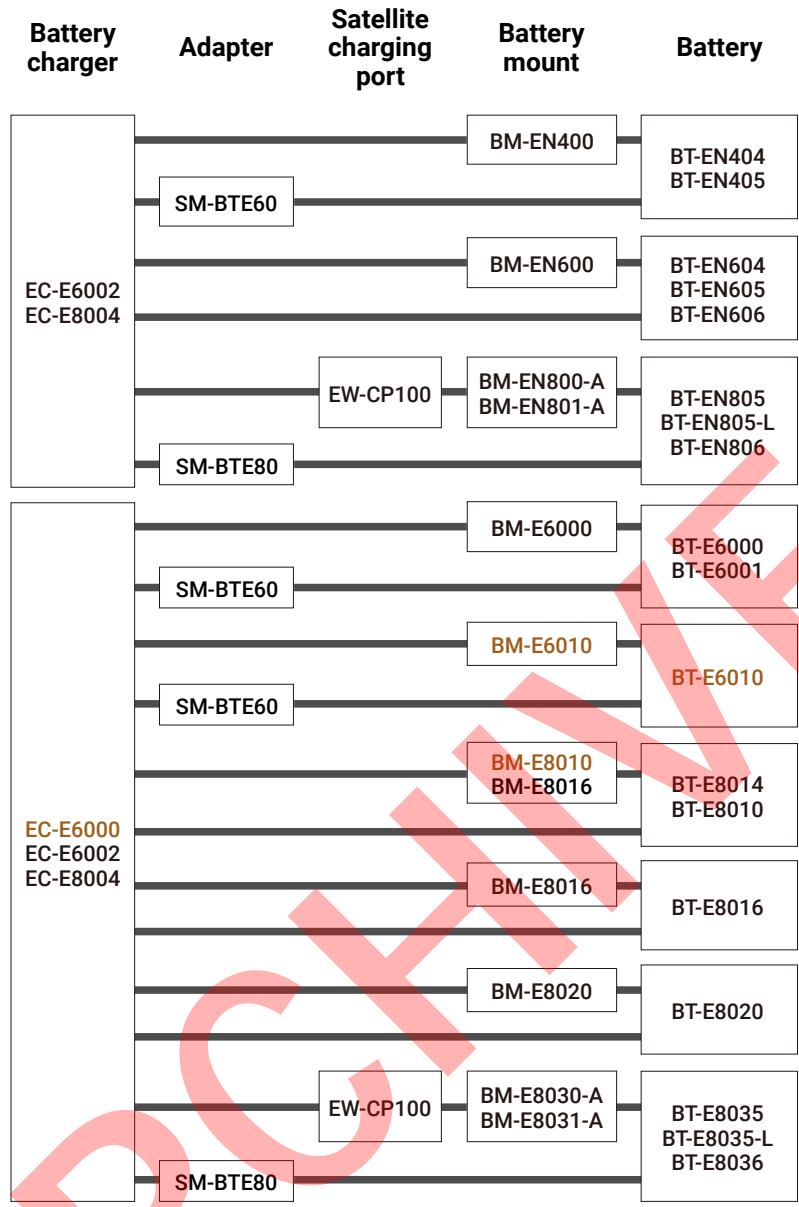

## SHIMANO ABS by Blubrake compatibility C-774

### ABS main unit and drive unit compatibility

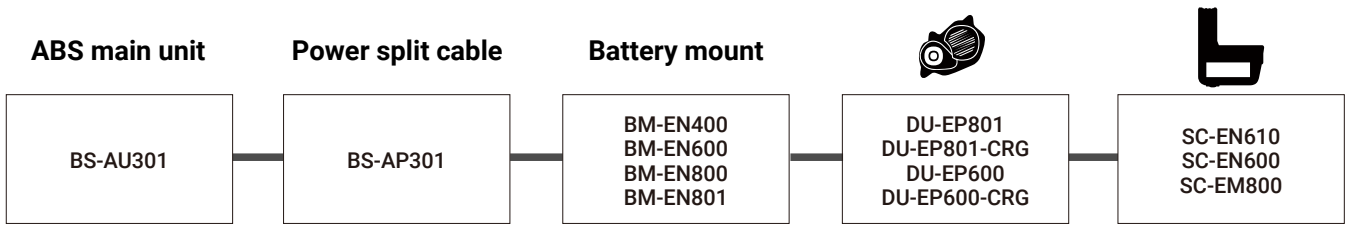

### Wheel speed sensor and rotor compatibility

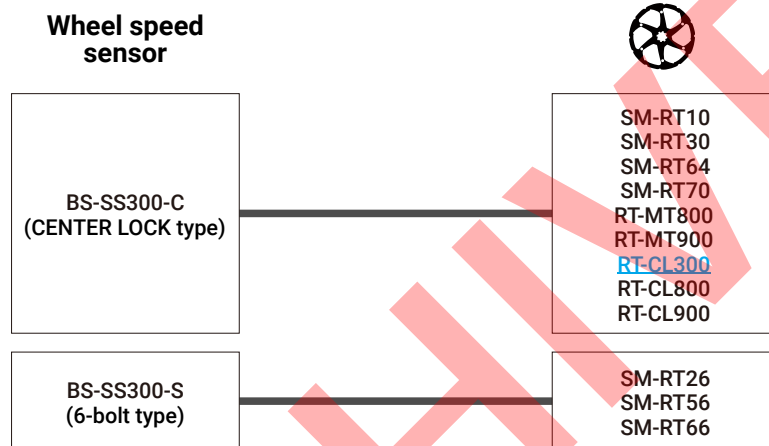

# Compatibility between SHIMANO brake system and BOSCH ABS C-775

Special J-kit for BOSCH ABS system is available.

## For BOSCH ABS

	Group-1	Group-2	Group-3
ABS mode	Touring / Allroad	Touring	Allroad / Trail / Off
Brake lever	<a href="#">BL-MT200-ABS</a>	<a href="#">BL-MT402-ABS</a>	<a href="#">BL-MT402-ABS</a>
Brake caliper	BR-MT200 (2-piston)	BR-MT420 (4-piston)	BR-MT420 (4-piston)
Brake hose type	BH59 (Special J-kit for BOSCH ABS)	BH90 (Special J-kit for BOSCH ABS)	BH90 (Special J-kit for BOSCH ABS)
Brake pads	BP-B05S-RX	BP-D03S-RX BP-D02S-MX	BP-D03S-RX BP-D02S-MX
Front rotor (6-bolt type)	SM-RT26 (180 mm)	SM-RT66 (180, 203 mm)	SM-RT66 (203, 220 mm)
Front rotor (CENTER LOCK type)	SM-RT10 (180 mm)	SM-RT64 (180, 203 mm) <a href="#">RT-CL300</a> (180, 203 mm) SM-RT30 (180, 203 mm)	SM-RT30 (203 mm) <a href="#">RT-CL300</a> (180, 203 mm) SM-RT64 (203, 220 mm)
Oil	SHIMANO MINERAL OIL	SHIMANO MINERAL OIL	SHIMANO MINERAL OIL

\* Please note that the brake levers compatible with BOSCH ABS has narrower adjustment range of grip distance compared to other levers, and the nominal grip distance is also wider.

## For BOSCH ABS Pro

	Group-1	Group-2
ABS mode	Trail Pro / Race / Off	Trail Pro / Race / Off
Brake lever	<a href="#">BL-M8200</a>	<a href="#">BL-M9220</a>
Brake caliper	<a href="#">BR-M8220</a> (4-piston)	<a href="#">BR-M9220</a> (4-piston)
Brake hose type	BH90 (Special J-kit for BOSCH ABS)	BH90 (Special J-kit for BOSCH ABS)
Brake pads	BP-D03S-RX BP-D02S-MX BP-P03A-RF BP-P04C-MF	BP-D03S-RX BP-D02S-MX BP-P03A-RF BP-P04C-MF
Front rotor (6-bolt type)	SM-RT66 (203, 220 mm)	SM-RT66 (203, 220 mm)
Front rotor (CENTER LOCK type)	RT-CL900 (203 mm) RT-CL800 (203 mm) RT-CL700 (203 mm)	RT-CL900 (203 mm) RT-CL800 (203 mm) RT-CL700 (203 mm)
Oil	SHIMANO LOW VISCOSITY OIL	SHIMANO LOW VISCOSITY OIL

## Grip Distance

Please be noted that the Brake Levers compatible with BOSCH ABS has narrower adjustment range of grip distance.

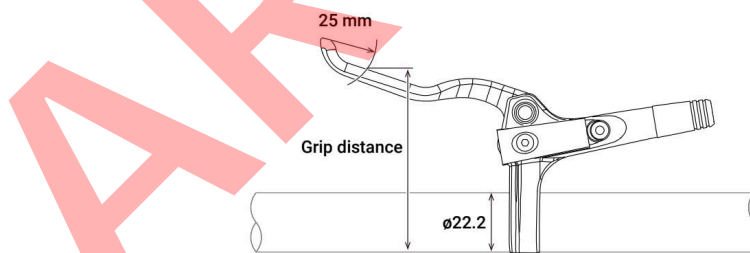

BOSCH ABS model	Brake lever	Grip distance	
		Min. (mm)	Max. (mm)
ABS Pro	<a href="#">BL-M9220</a>	58	100
	<a href="#">BL-M8200</a>	58	100
ABS	<a href="#">BL-MT200-ABS</a>	83	94
	<a href="#">BL-MT402-ABS</a>	80	98

## Wheel speed sensor mount adapter and rotor compatibility

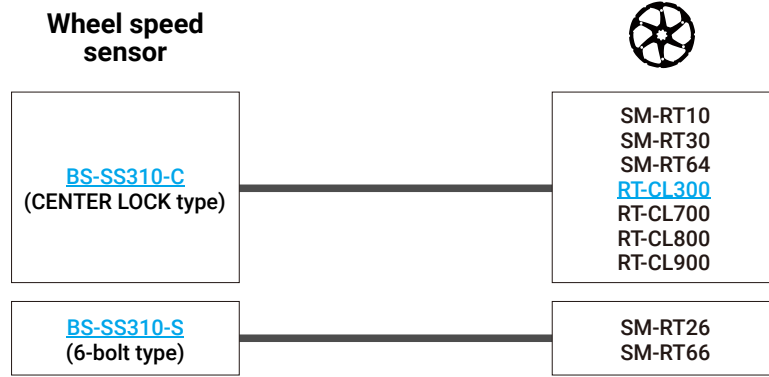

## Crank arm for 3rd party E-BIKE system

C-783

### BOSCH eBike systems



\* Contact BOSCH for details of compatible drive unit

ARCHIVE

## Compatibility chart of E-TUBE PROJECT Cyclist/Professional v5.4.4

Di2 with [BT-DN320](#)

C-473

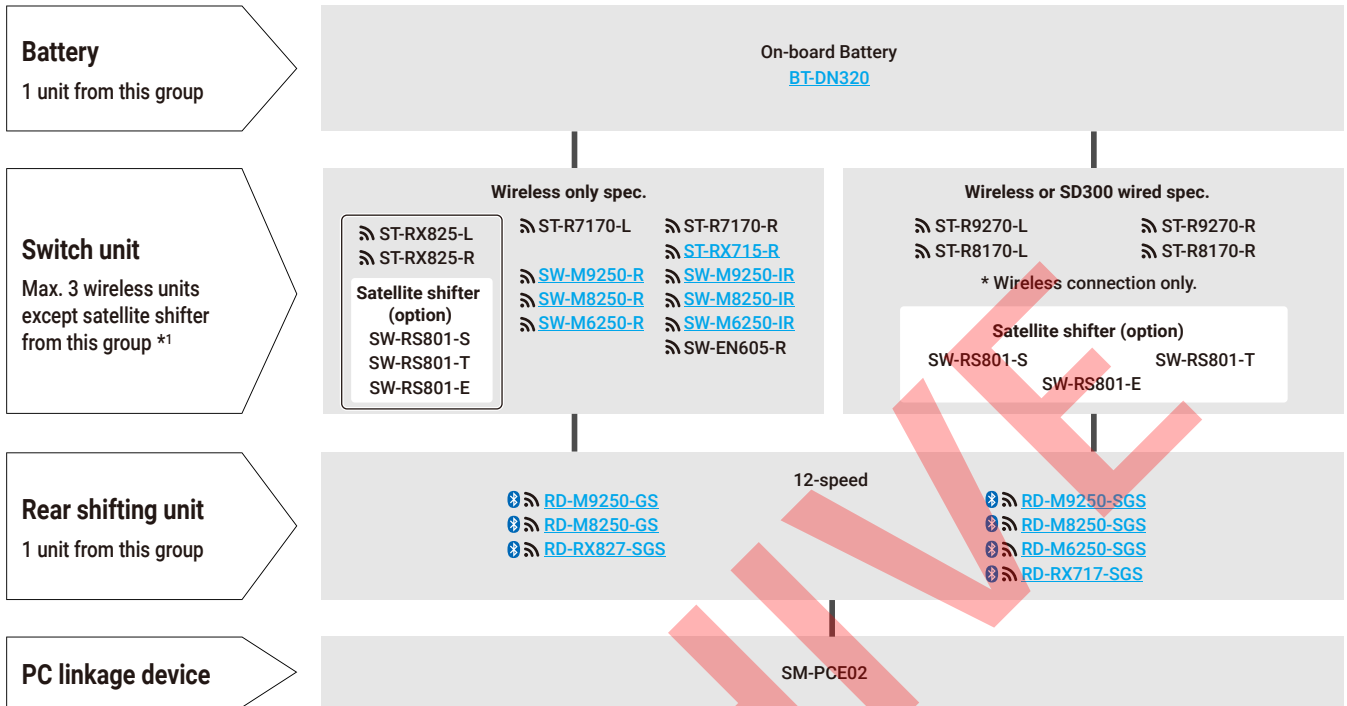

### Limitation of function with [BT-DN320](#)

\*1 The number of connectable wireless units paired by App is limited as follows:

- DUAL CONTROL LEVER: ST-R max. one unit, ST-L max. one unit
- Switch unit: maximum of one SW-R/IR

## Di2 with BT-DN300

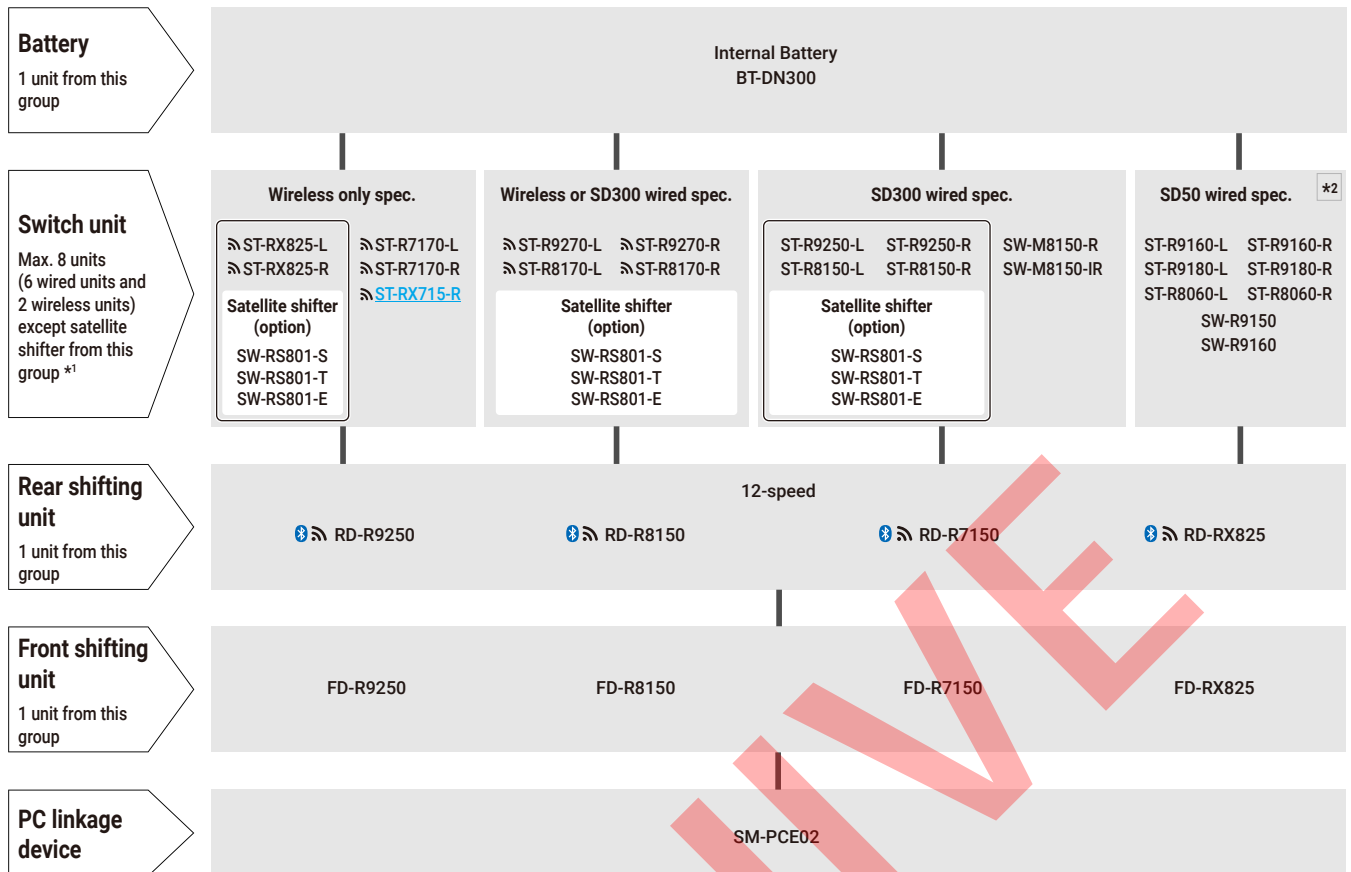

### Limitation of function with BT-DN300

\*1 The number of connectable wireless units paired by App is limited as follows:

- DUAL CONTROL LEVER: ST-R max. one unit, ST-L max. one unit

\*2 EW-AD305 is needed.

# Di2 with BM-DN100 / BT-DN110

- SM-BTR1 is not displayed on E-TUBE PROJECT (BM-DN100 is displayed)
- BT-DN110-A is displayed as BT-DN110 on E-TUBE PROJECT

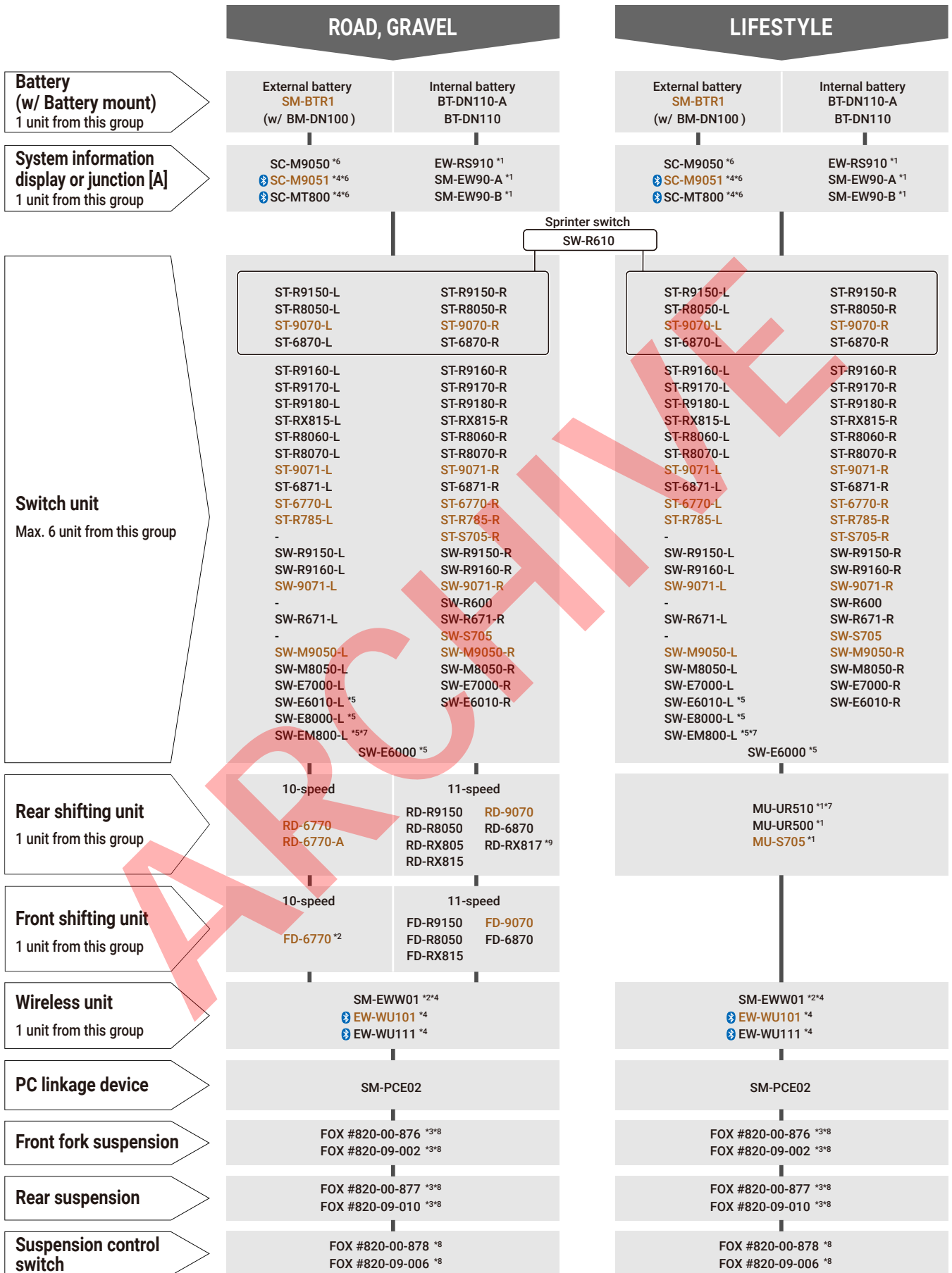

# MTB

**Battery  
(w/ Battery mount)**  
1 unit from this group

**System information  
display or junction [A]**  
1 unit from this group

**Shift switch**  
Max. 6 unit from this group

**Rear shifting unit**  
1 unit from this group

**Front shifting unit**  
1 unit from this group

**Wireless unit**  
1 unit from this group

**PC linkage device**

**Front fork suspension**

**Rear suspension**

**Suspension control  
switch**

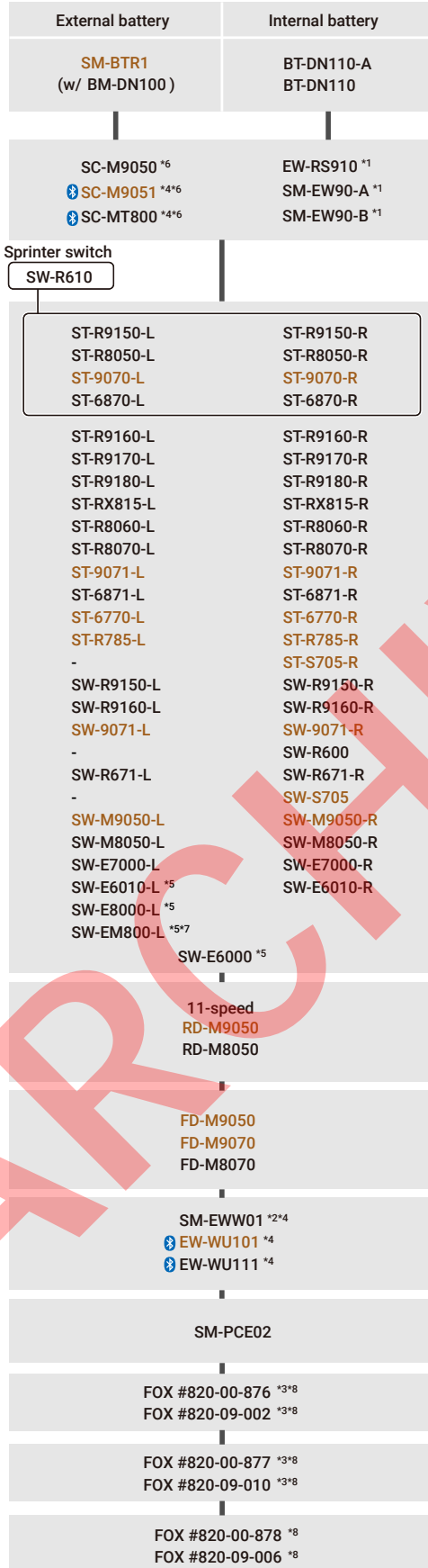

## Limitation of function with BM-DN100 / BT-DN110

- \*1 Shifting adjustment mode for MU-S705, MU-UR500 and MU-UR510 is not supported (need E-TUBE PROJECT to adjust)
- \*2 Not supported by E-TUBE PROJECT Cyclist
- \*3 A designated control switch and/or the combination SW-M9050/SW-M8050-L with SC-M9050/SC-M9051/SC-MT800 is required to operate
- \*4 The system accepts just 1 unit with wireless chip (doesn't work if plural units with wireless chip are connected)
- \*5 Need to change switch setting by E-TUBE PROJECT
- \*6 SC-M9050, SC-M9051 or SC-MT800 is required for SYNCHRONIZED SHIFT in MTB category
- \*7 This unit has SD300 port, and needs EW-AD305 for connection with SD50 port unit
- \*8 Only supported by E-TUBE PROJECT Cyclist
- \*9 For front single models only. Cannot be used in combination with a front derailleur.

ARCHIVE

Di2 with **SM-BMR1** / **SM-BMR2** / **SM-BTR2**

SM-BTR1 is not displayed on E-TUBE PROJECT (SM-BMR1 or SM-BMR2 is displayed)

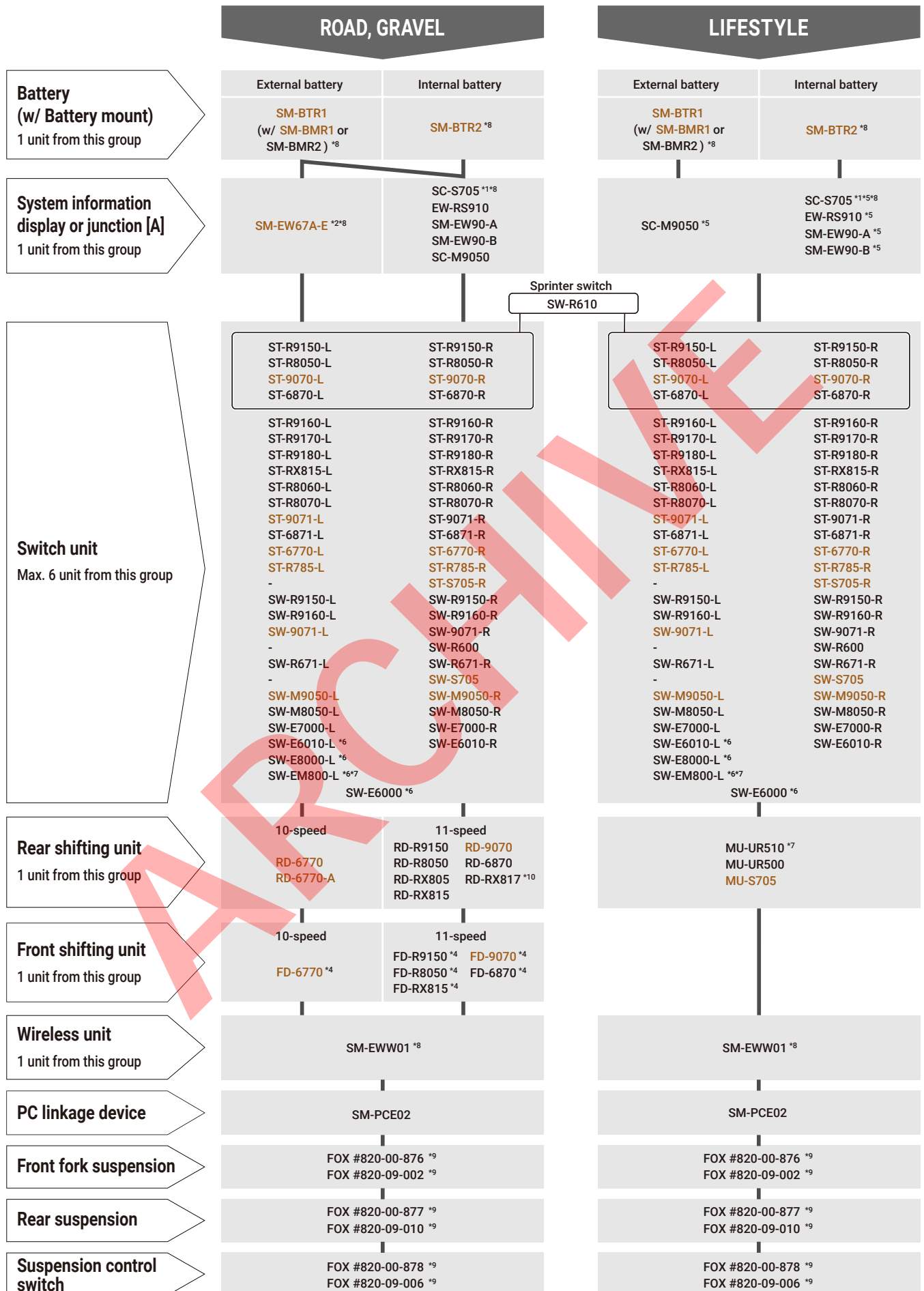

# MTB

**Battery  
(w/ Battery mount)**  
1 unit from this group

**System information  
display or junction [A]**  
1 unit from this group

**Switch unit**  
Max. 6 unit from this group

**Rear shifting unit**  
1 unit from this group

**Front shifting unit**  
1 unit from this group

**Wireless unit**  
1 unit from this group

**PC linkage device**

**Front fork suspension**

**Rear suspension**

**Suspension control  
switch**

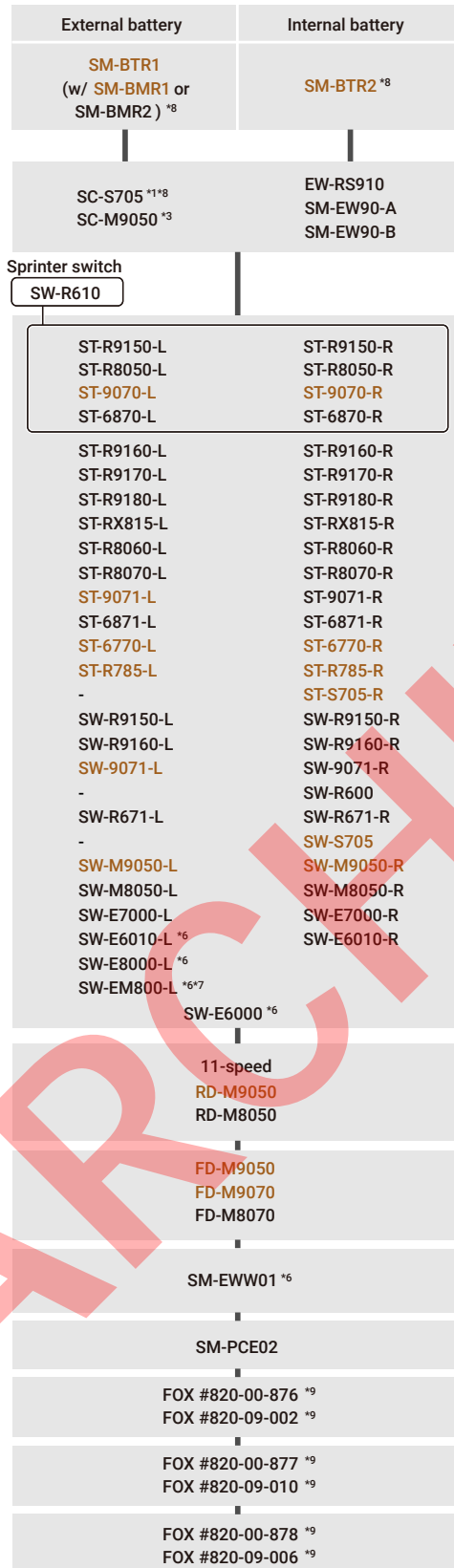

## Limitation of function with SM-BMR1 / SM-BMR2 / SM-BTR2

\*1 SC-S705

- Front derailleur position will not appear on display.
- Recovery from Rear derailleur protection function is not available.
- Front / Rear derailleur adjustment mode is not available. Use E-TUBE PROJECT software.
- SC-S705 has only 1 SD50 port for ST / SW.
- SC-S705 may not turn on the display by front shift switch.

\*2 SM-BCR2 requires any device which has charging port.

SM-EW67-A-E (Junction [A]) is not compatible with SM-BCR2 and SM-BTR2.

\*3 SC-M9050 is required for SYNCHRONIZED SHIFT in case with MTB-type Rear Derailleur

\*4 SYNCHRONIZED SHIFT is not available with Road-type Rear Derailleur

\*5 Shifting adjustment mode for MU-S705 , MU-UR500 and MU-UR510 is not supported (need E-TUBE PROJECT to adjust)

\*6 Need to change switch setting by E-TUBE PROJECT

\*7 This unit has SD300 port, and needs EW-AD305 for connection with SD50 port unit

\*8 Not supported by E-TUBE PROJECT Cyclist

\*9 Only supported by E-TUBE PROJECT Cyclist

\*10 For front single models only. Cannot be used in combination with a front derailleur.

## Di2 with FH-U6060

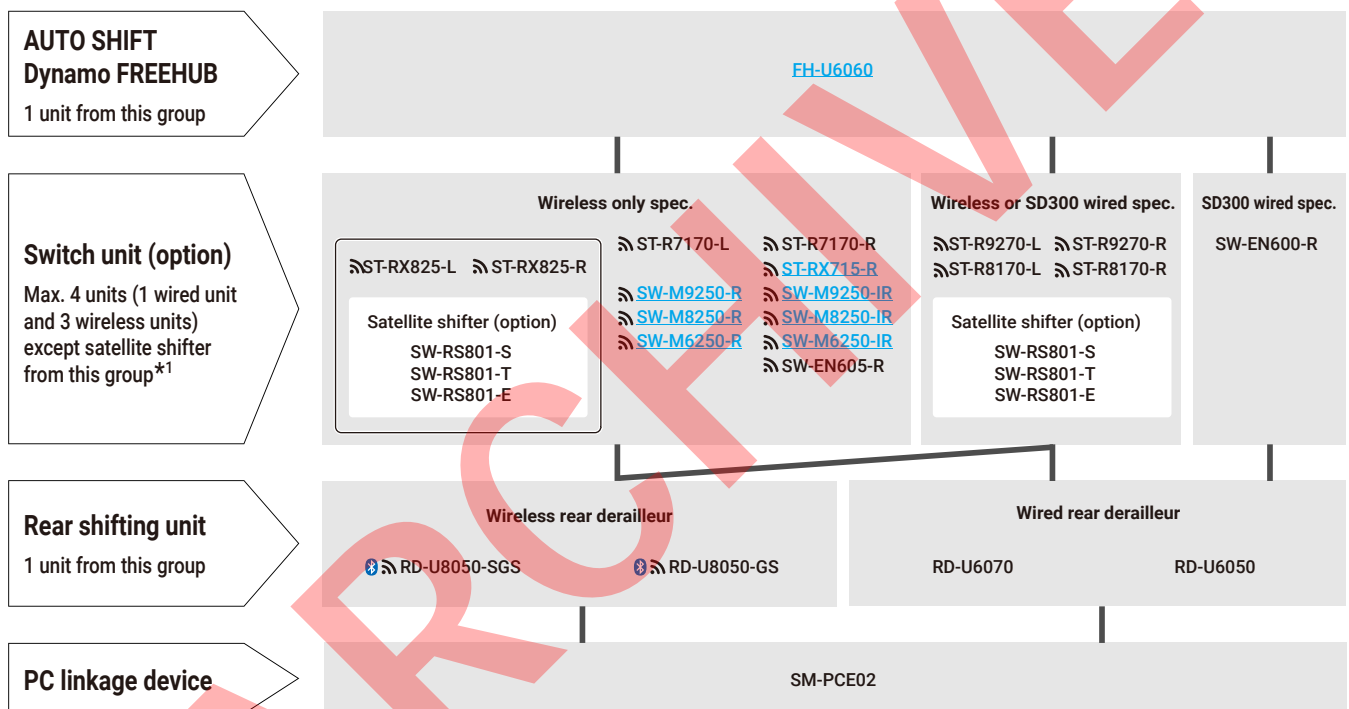

## Limitation of function with FH-U6060

\*1 The number of connectable wireless units paired by App is limited as follows:

- DUAL CONTROL LEVER: ST-R max. one unit, ST-L max. one unit
- Switch unit: maximum of one SW-R/IR

## Compatibility chart of E-TUBE PROJECT Cyclist/Professional v5.4.4

### Di2 with EW-PS300

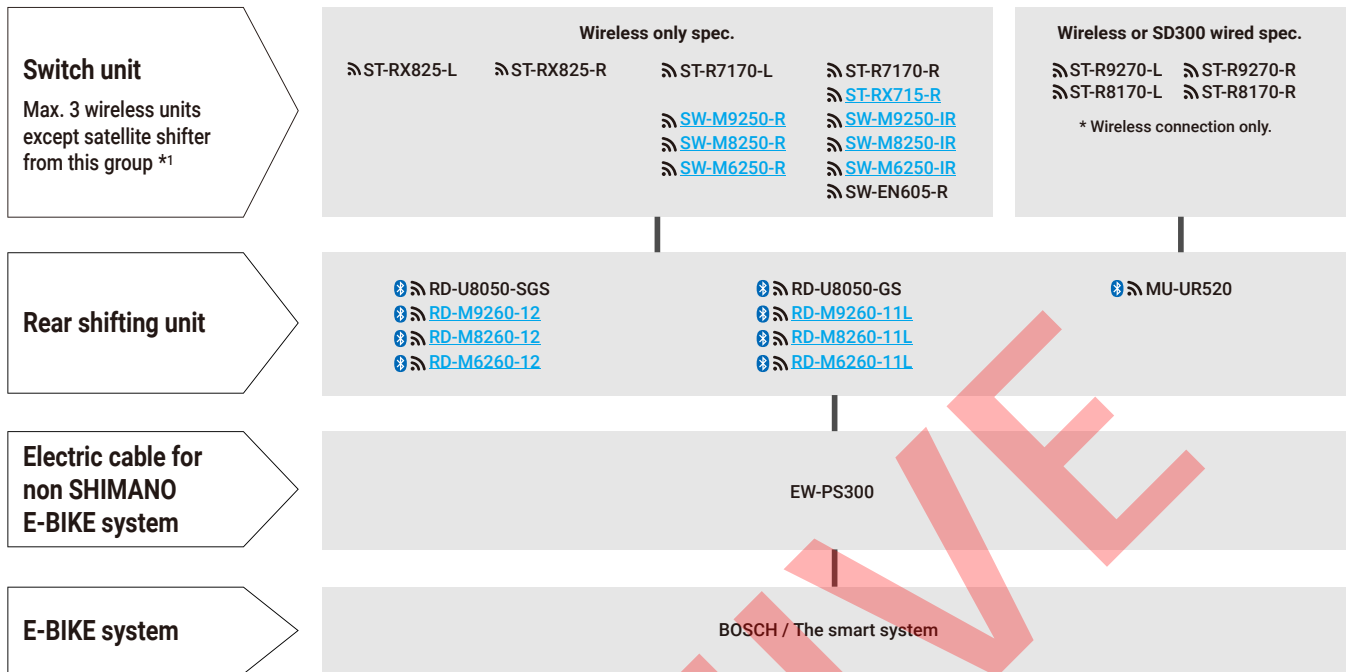

### Limitation of function

\*1 The number of connectable wireless units paired by App is limited as follows:

- DUAL CONTROL LEVER: ST-R max. one unit, ST-L max. one unit
- Switch unit: maximum of one SW-R/IR

## Di2 with EW-EX310 for ROAD/GRAVEL 12-speed (front derailleur compatible)

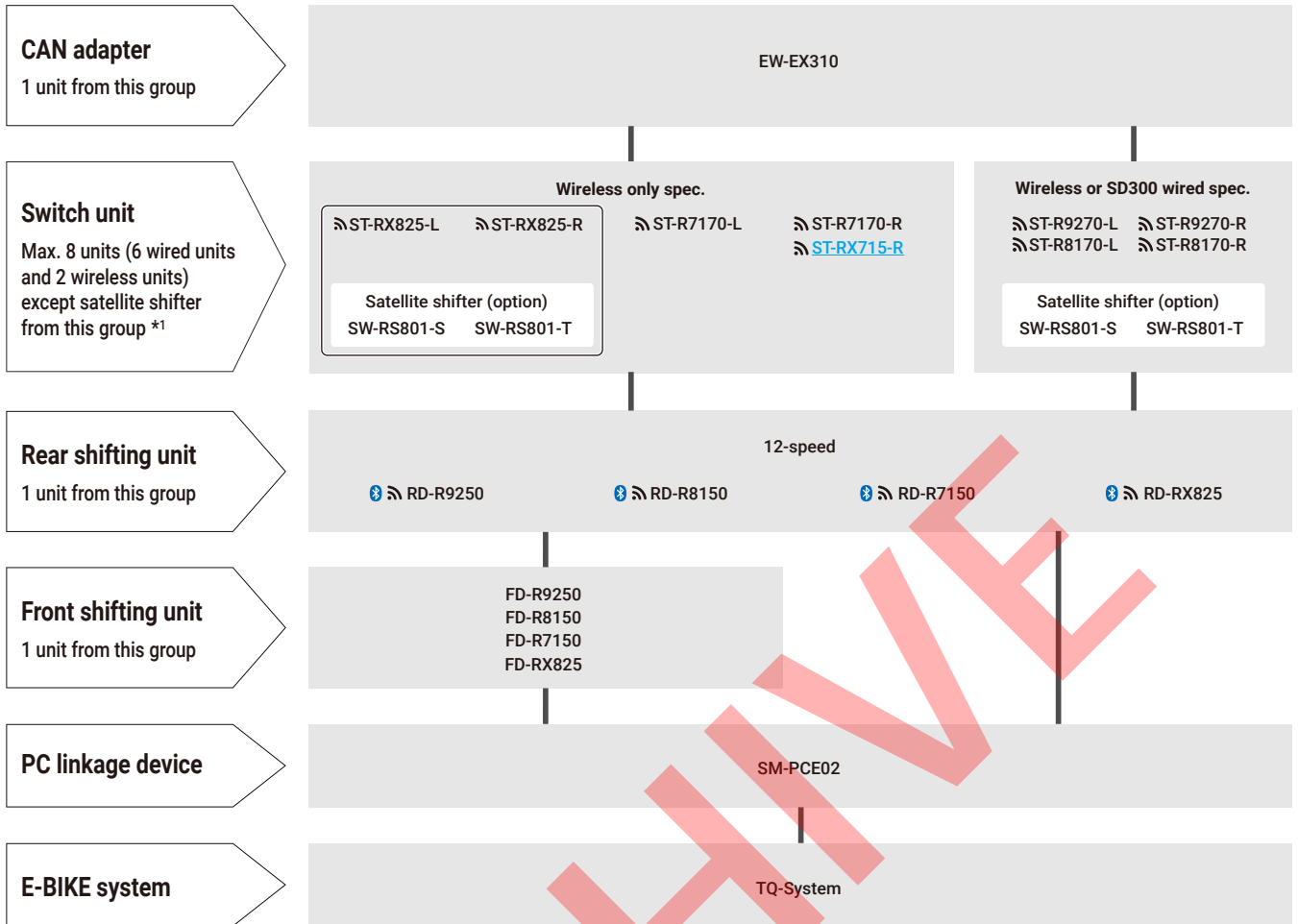

### Limitation of function

\*1 The number of connectable wireless units paired by App is limited as follows:

- DUAL CONTROL LEVER: ST-R max. one unit, ST-L max. one unit

## Di2 with EW-EX310 for MTB/GRAVEL 12/11-speed, LIFESTYLE 11/10-speed



### Limitation of function

\*1 The number of connectable wireless units paired by App is limited as follows:

- DUAL CONTROL LEVER: ST-R max. one unit, ST-L max. one unit
- Switch unit: maximum of one SW-R/IR

## Di2 with EW-EX010

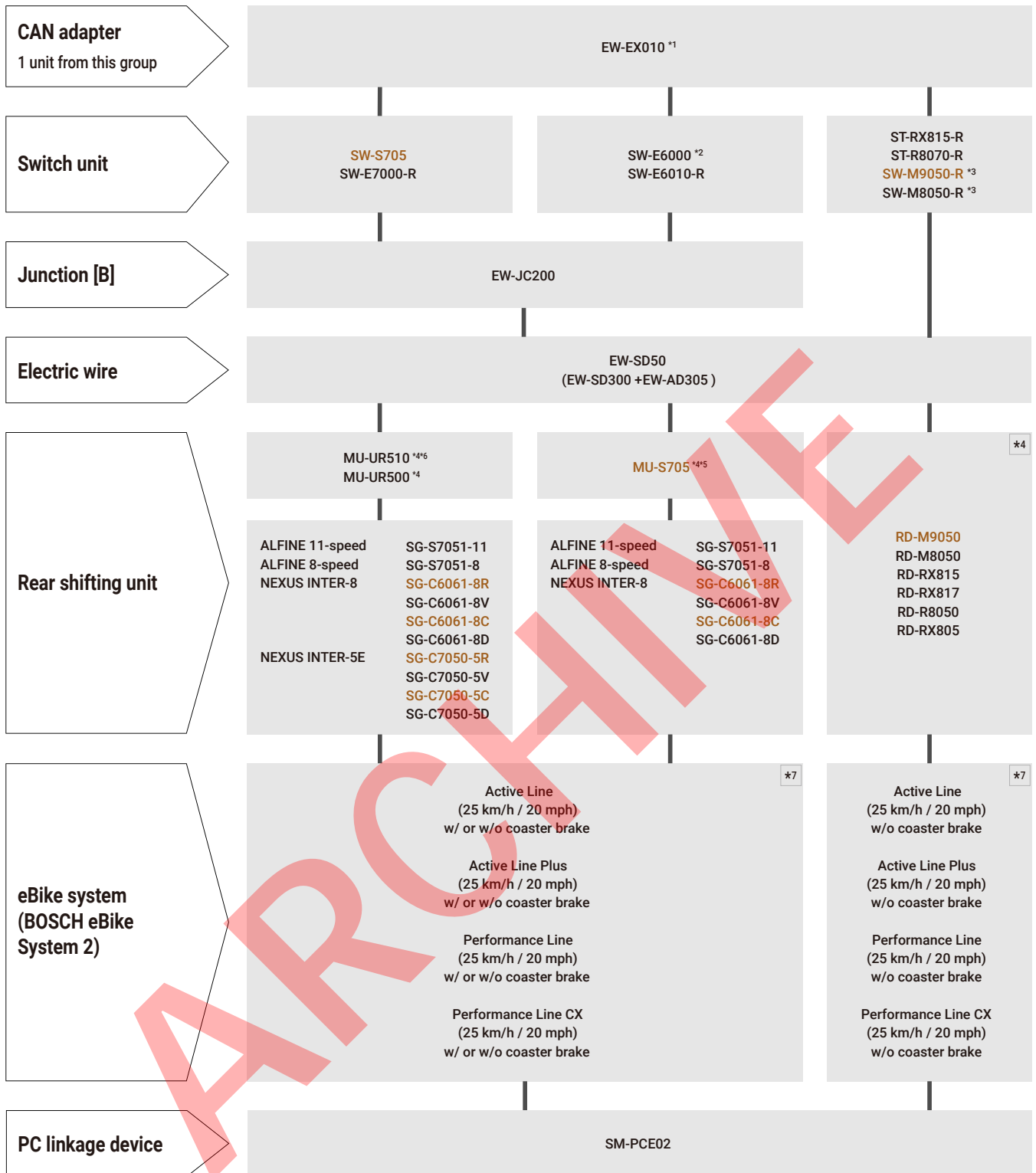

### Limitation of function

- \*1 EW-EX010 and BOSCH eBike system are connected by Y-harness which is provided by BOSCH
- \*2 Need to change switch setting by E-TUBE PROJECT.
- \*3 Cannot change manual gear shifting to automatic gear shifting and its opposite.
- \*4 Automatic gear shifting is available only with internal geared hub by MU-S705 / MU-UR500 / MU-UR510. (Not available with rear derailleur)
- \*5 Compatible with 8-speed and 11-speed internal geared hub system only.
- \*6 This unit has SD300 port and needs EW-AD305 for connection with SD50 port unit.
- \*7 No compatibility with "Classic+ Line" and "Performance Line (45 km/h)".

## Compatibility between Bracket and ID/SC

C-548

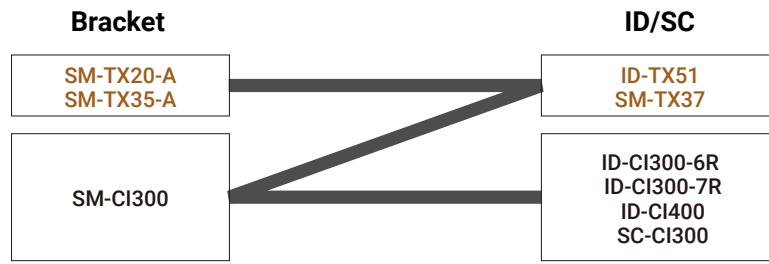

ARCHIVE