

SHIMANO

2024-2025

Products compatibility Information

Compatibilities are subject to change without prior

Visit SHIMANO PRODUCT WEBSITE for the latest information.

Word definitions

BB	Bottom bracket	HRB, BR	Roller brake
BC	Brake outer casing	I-SPEC	Integration mounting system of brake lever and shifter
BCC	Charger cord		
BCR, EC	Battery charger	ID	CI-DECK
BH	Brake hose	JC	Junction
BL	Brake lever	LP	Light
BM	Battery mount	MF	Multiple freewheel
BR	Brake caliper	MU	Motor unit
BTC	Battery case	O.L.D.	Over Locknut Dimension
BT, BTR	Battery	OT	Shift outer casing
CB	Coaster brake	P.C.D.	Pitch Circle Diameter
CC, EWC	Wire cover	PCE	PC linkage device
CD	Chain device	PD	Pedal
CG	Chain guard	PM	POWER MODULATOR
CJ	Cassette joint	QR	Quick release
CN	Chain	RD	Rear derailleur
CP	Spoke protector	RT, SMRT	Rotor
CR	Chainring	RTAD	Rotor adapter
CS	Cassette	SB	REVOSHIFT shifter integrated with brake lever
CT	Chain tensioner		
DH	Hub dynamo	SC	Cycle computer, System information display
DU	Drive unit		
EW	Electric wire	SF	Single freewheel
EWCP	Satellite charging port	SG	Internal geared hub
EWEX	Di2 adapter, CAN adapter	SL	Shifter
EWSW	Satellite system ON/OFF switch	SPD	SHIMANO PEDALING DYNAMICS
EWU, WU	Wireless unit	SPD-SL	SHIMANO PEDALING DYNAMICS-SL
FC	Crankset, Crank arm	ST	DUAL CONTROL LEVER : Shifter integrated with brake lever
FD	Front derailleur		
FH	FREEHUB	SW	Shift switch, Switch unit, Satellite shifter
GM	Grommet		
HB	Front hub	WH	Wheel
HP	Head parts		

Compatibility

Drivetrain for MTB, LIFESTYLE components C-432

Rear drivetrain compatibility [MTB, LIFESTYLE]

C-433 C-434 C-558 C-435 C-436 C-437 C-438 C-439
C-546

Front drivetrain compatibility [MTB, Trekking, LIFESTYLE]

C-440 C-559 C-441 C-442 C-445 C-446

Front derailleur and crankset

C-447

Front derailleur and chain line (TOURNEY)

C-448

Crankset, bottom bracket and chain line [MTB, LIFESTYLE]

C-449 C-450

Drivetrain for ROAD, Gravel, LIFESTYLE components C-453

Rear drivetrain compatibility

C-454

Front drivetrain compatibility

C-455

Brake system for ROAD, Gravel, LIFESTYLE components C-737

Brake systems compatibility [ROAD]

C-456

Hydraulic systems compatibility [ROAD, Gravel]

C-499

Hydraulic systems compatibility [URBAN, LIFESTYLE]

C-500

Compatibility of BL-U8000 with shifter

C-738

Compatibility of BL-UR405 with shifter

C-755

I-SPEC C-156

Compatibility of I-SPEC shifter and brake lever

C-157

Compatibility of Shift Switch and I-SPEC brake lever

C-744

Disc brake C-460

Disc brake caliper and rotor compatibility C-461

Compatibility of lock ring with hubs C-612

Compatibility between brake systems (MT400 series) C-606

Combination chart (mechanical disc brake) C-462 C-463 C-464

Compatibility between hydraulic disc brake hose C-186 C-732 C-733

Compatibility between banjo screw C-625

Brake pad line-up C-192 C-652 C-653

Disc brake mount adapter C-193 C-194 C-195

Rim brake C-200

Brake / Shoe line-up C-201

Brake shoe recommendation to rim width C-202

Cable System C-605

Polymer-coated brake cable (BC-9000 / BC-R680) compatible chart C-306

V-BRAKE and Roller brake C-465

Compatibility between brake systems C-466

Brake lever with switch compatibility C-467 C-468 C-469

Cassette C-544

FREEHUB and cassette spline compatibility C-731

Compatibility between rear derailleur and cassette gear teeth
[ROAD, Gravel, METREA] C-254 C-648 C-255 C-256 C-257
C-258 C-259

LINKGLIDE cassette and FREEHUB compatibility C-649

ALFINE, NEXUS components C-470

Available combinations of the dropout, sprocket and crankset for designing the frame C-471

Mechanical internal geared hub / SM (CJ) COMPATIBILITY CHART C-647

Sprocket and chain combination C-608

CARGO BIKE related components C-651

Compatibility for DIN 79010:2020-02 C-672

Spoke protector C-298

Spoke protector C-491

MTB, Gravel, LIFESTYLE C-299

ROAD, Gravel, METREA C-300

Spoke protector for Road C-302

E-BIKE compatibility chart C-431

Compatibility chart of E-TUBE PROJECT Cyclist/Professional v5.3.2 C-525

Drivetrain compatibility C-488 C-706 C-656 C-657 C-658 C-659

Switch unit / cycle computer and brake lever compatibility C-421

Battery and battery mount compatibility C-511

System on/off function compatibility C-629

Configuration of assist switch functions C-781

Speed sensor and drive unit compatibility C-549

Battery and battery charger compatibility C-562

ABS compatibility C-715

Electronic Product Information C-472

Compatibility chart of E-TUBE PROJECT Cyclist/Professional v5.3.2

C-473

Di2 compatibility for 3rd party E-BIKE system

C-429

CI-DECK C-547

Compatibility between Bracket and ID/SC

C-548

Rear drivetrain compatibility [MTB, LIFESTYLE]

9,10,11-speed rear drivetrain compatibility C-434

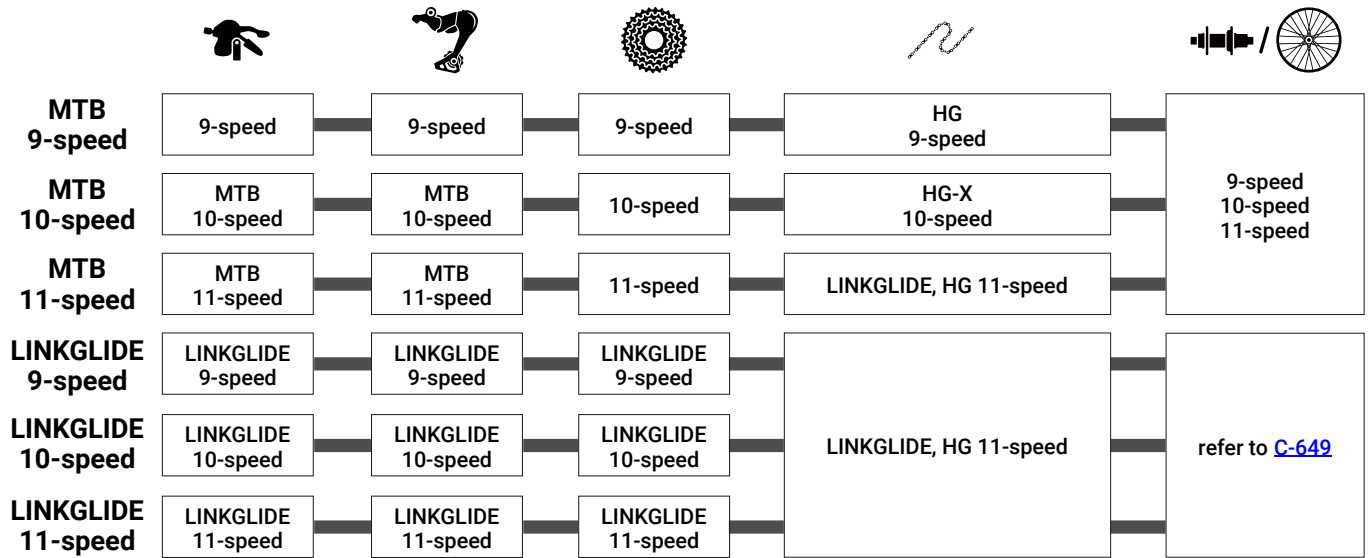

12-speed rear drivetrain (MICRO SPLINE) [MTB] C-558

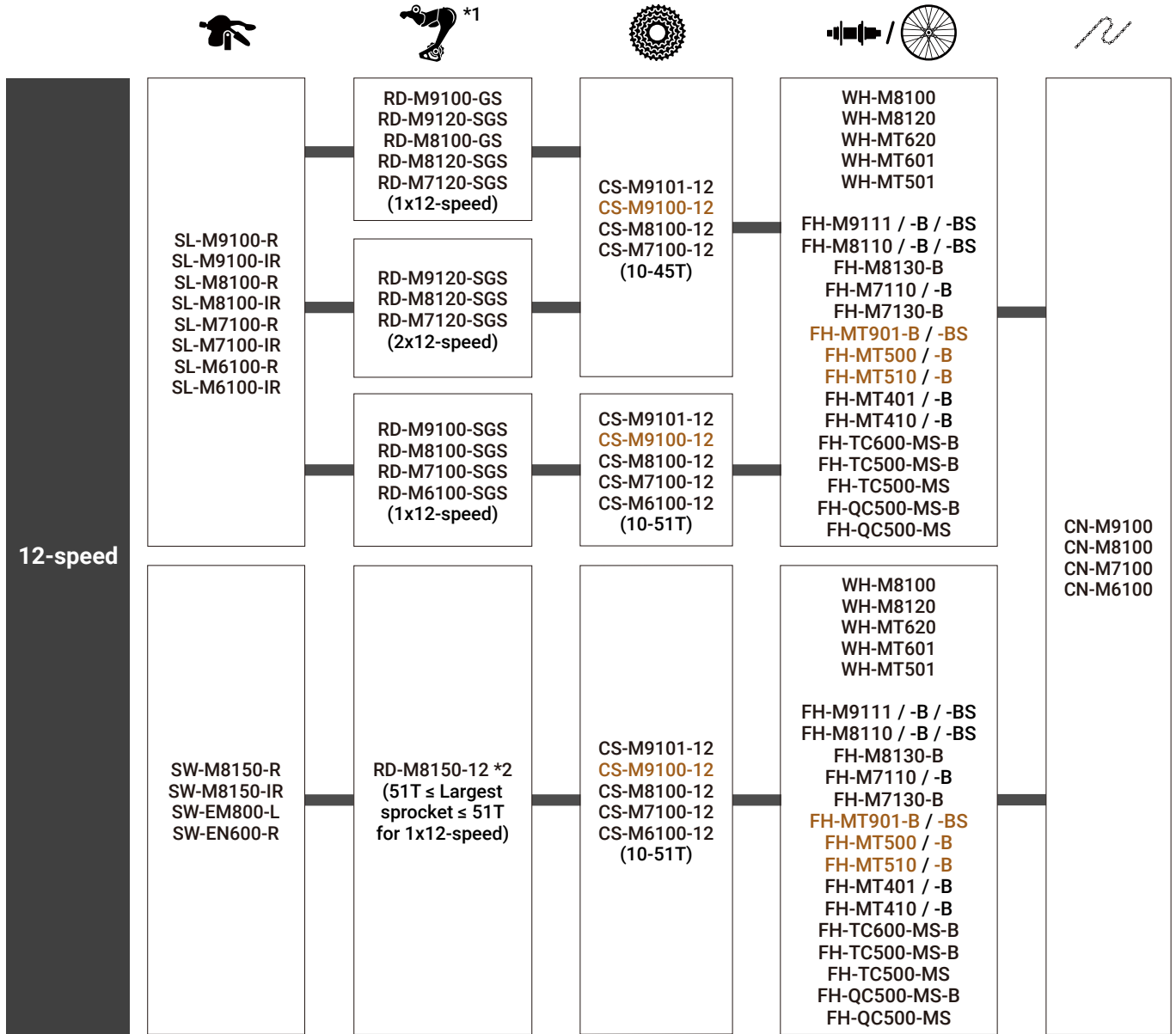

*1 Method to adjust the end adjustment screw is different from conventional rear derailleurs. For details, refer to dealer's manual.

*2 Only for E-BIKE

11-speed rear drivetrain [MTB, LIFESTYLE] C-435

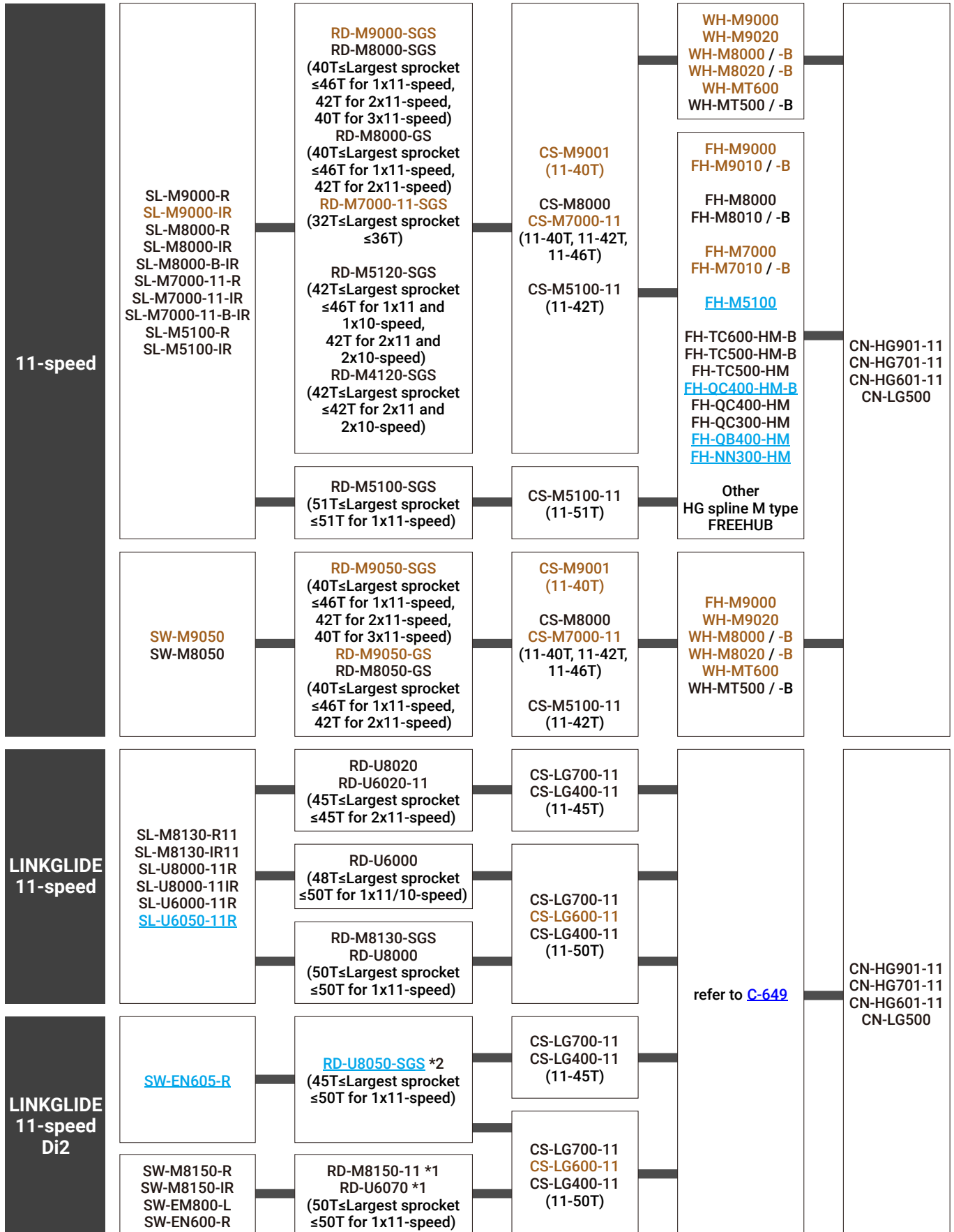
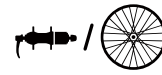

*1 Only for E-BIKE

*2 Only for BOSCH smart system

For SHIMANO E-BIKE SYSTEMS as well in later

10-speed rear drivetrain [MTB, LIFESTYLE] C-436

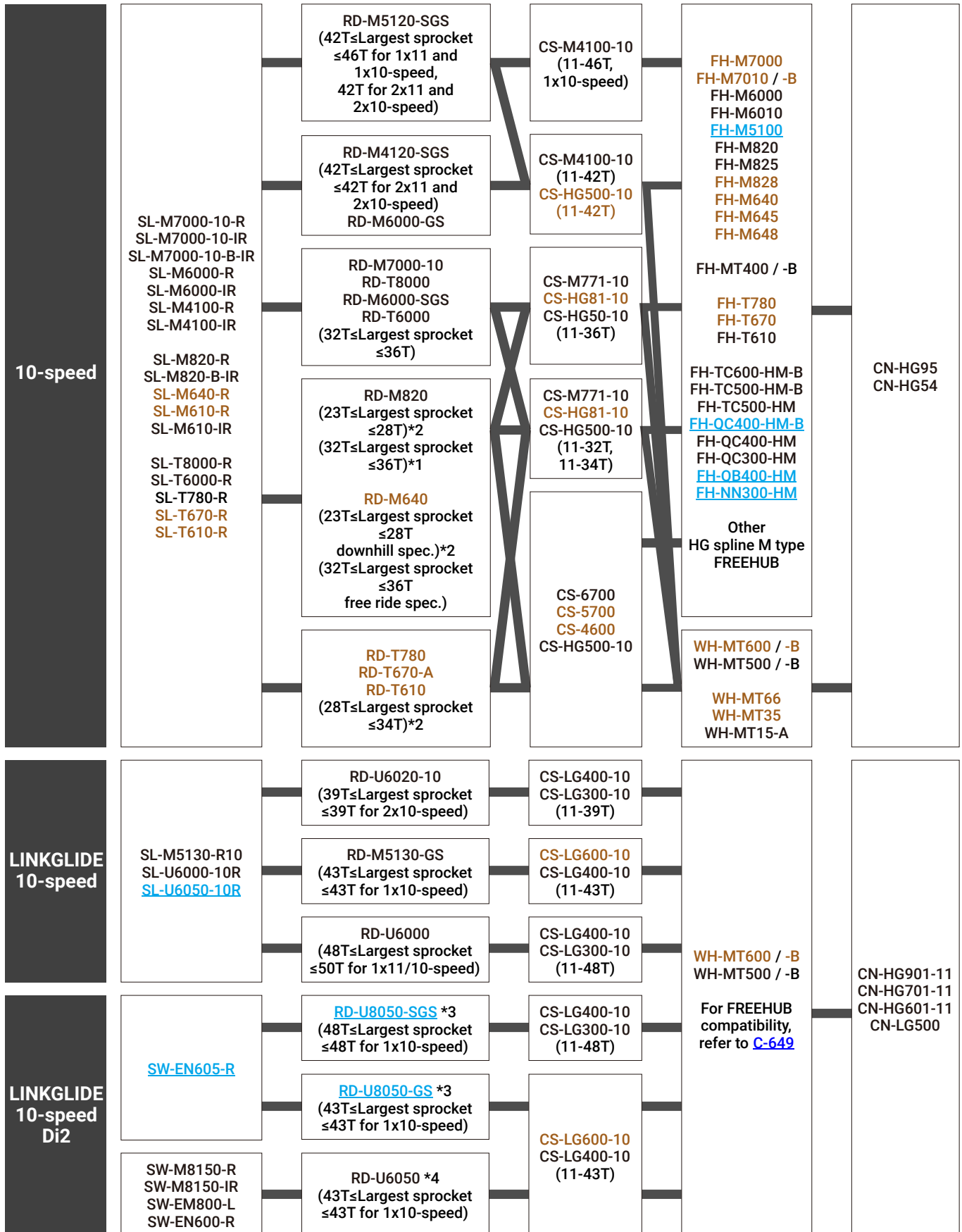
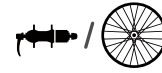

*1 Mode converter

*2 Compatible with ROAD cassette

*3 Only for BOSCH smart system
For SHIMANO E-BIKE SYSTEMS as well in later

*4 Only for SHIMANO E-BIKE SYSTEMS

9-speed rear drivetrain [MTB, LIFESTYLE] C-437

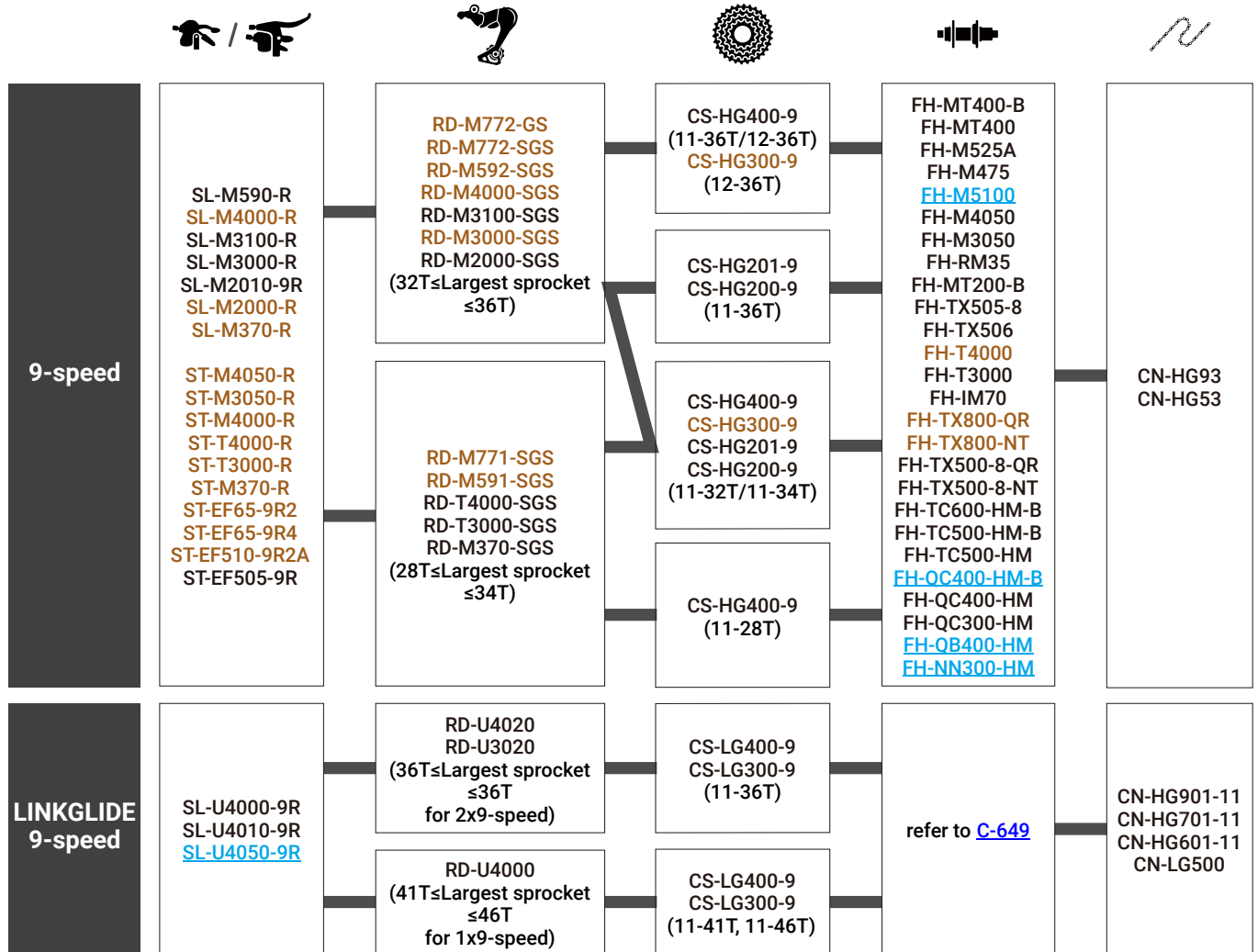

8-speed rear drivetrain [MTB] C-438

The rear derailleur for 8-speed can also be used for 7-speed drivetrain.

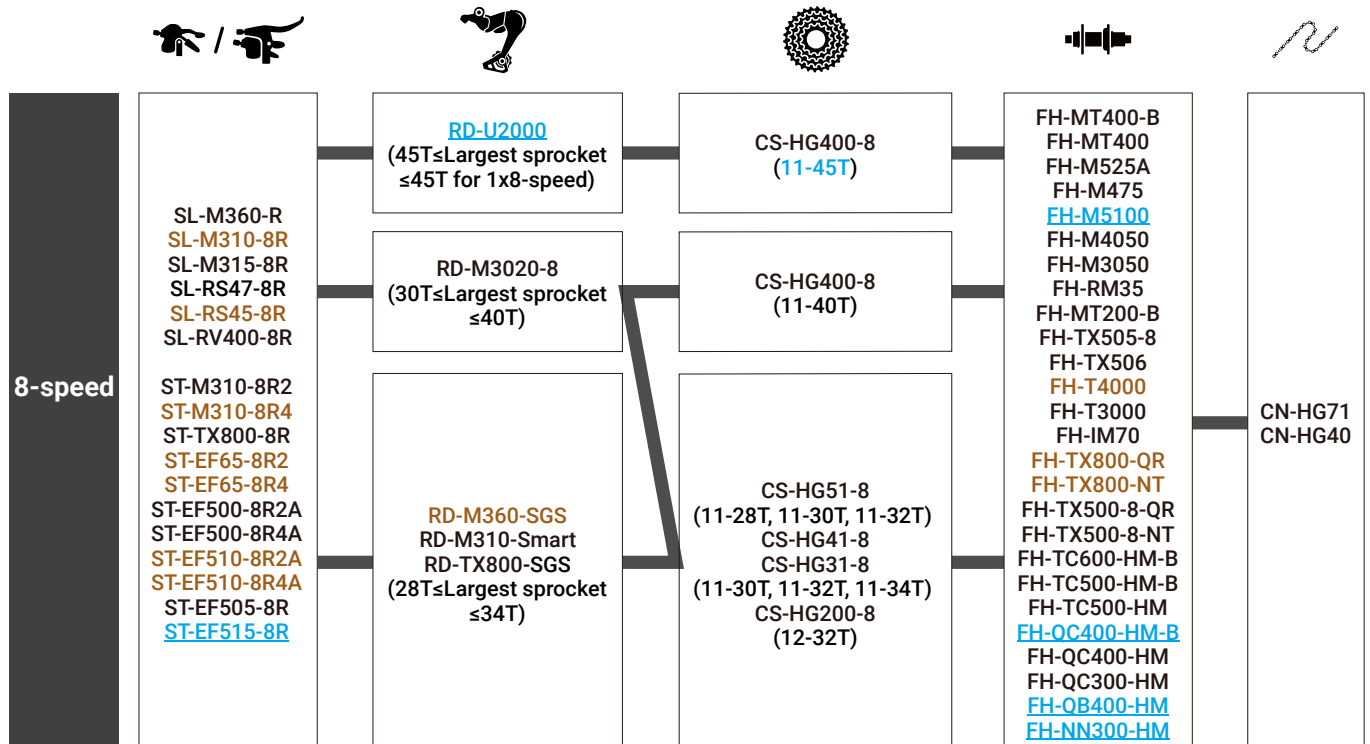

7-speed rear drivetrain [MTB] C-439

Cassette - FREEHUB spec.

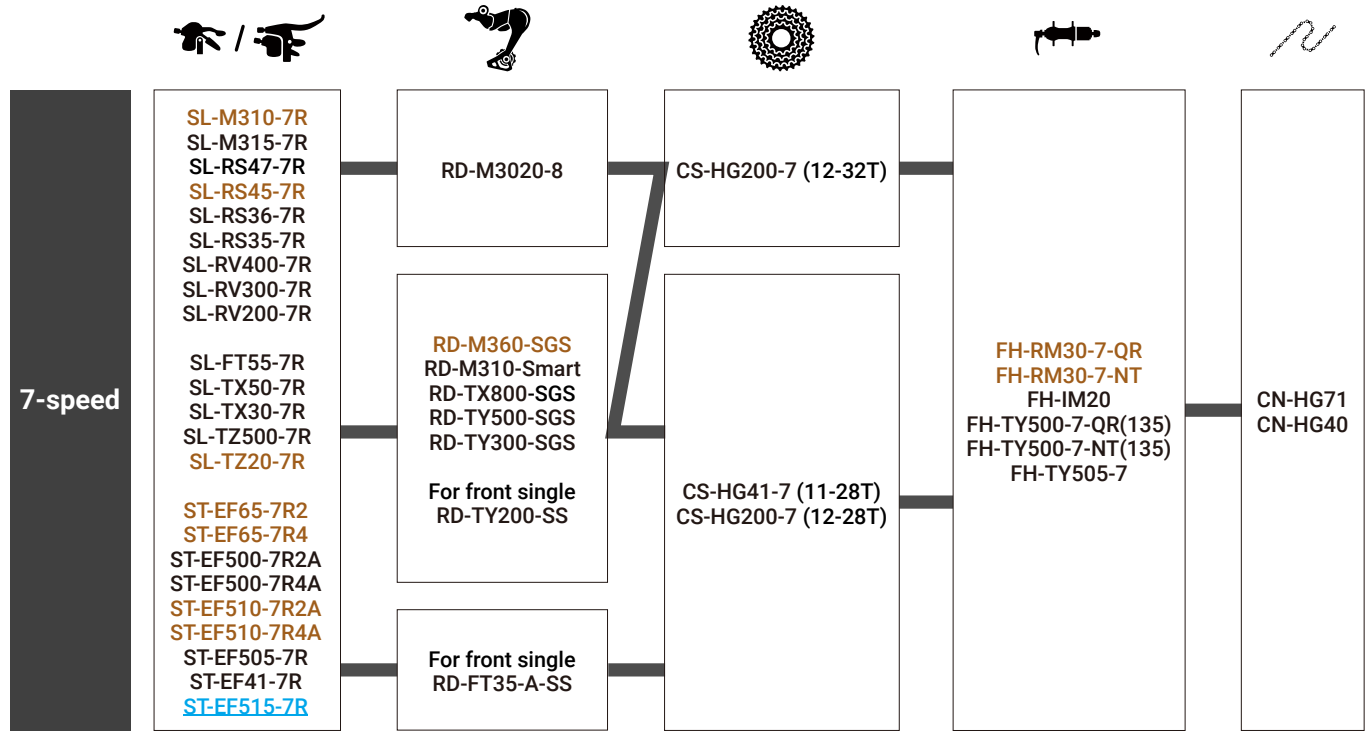

Multiple freewheel - Rear hub spec.

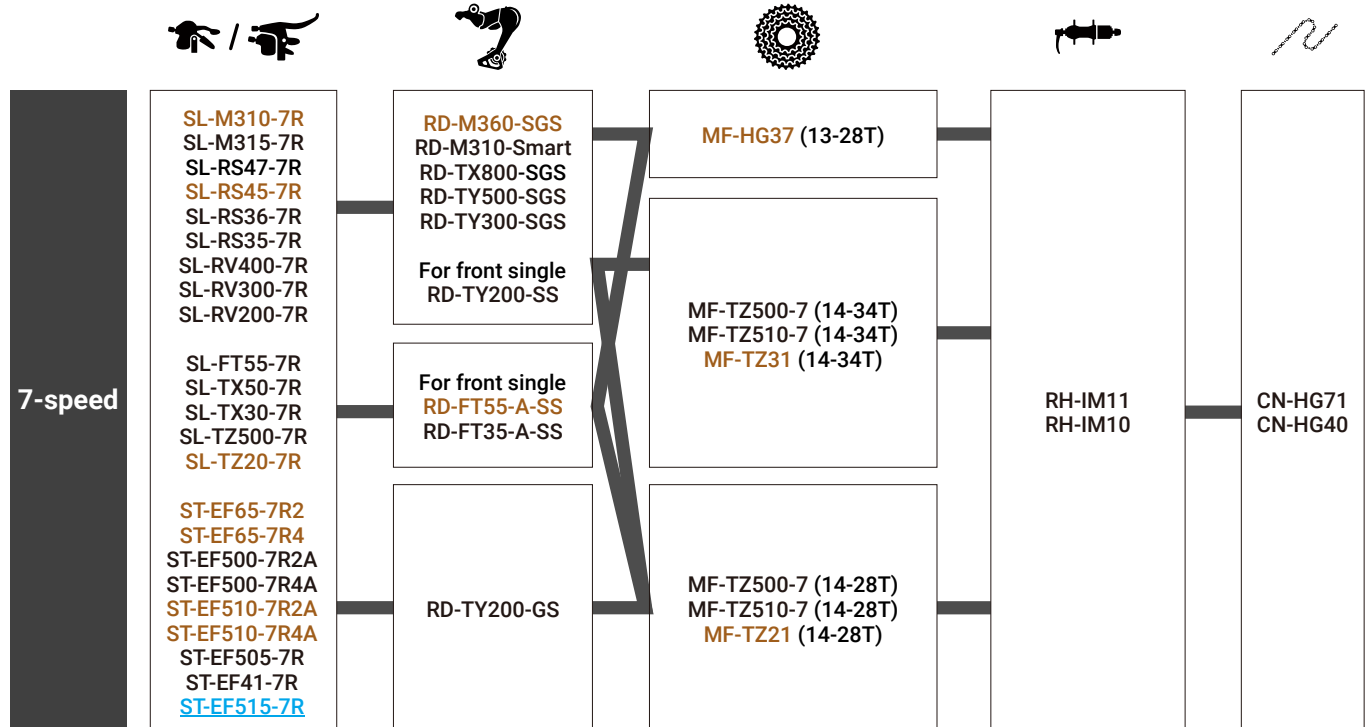

6-speed rear drivetrain [MTB] C-546

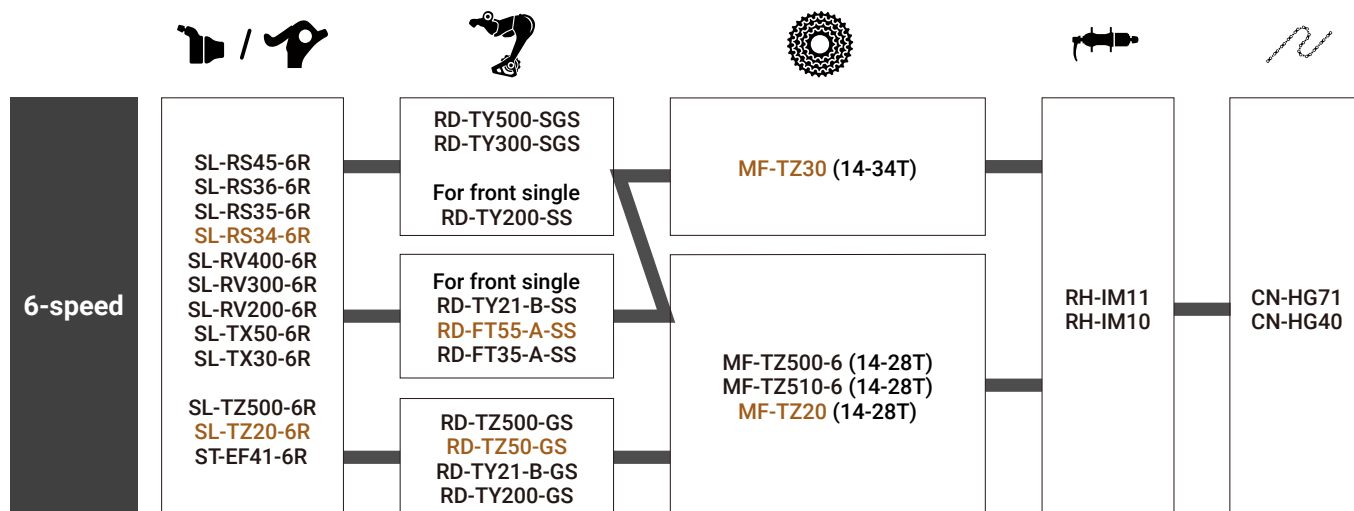

Front drivetrain compatibility [MTB, Trekking, LIFESTYLE]

C-440

12-speed front drivetrain [MTB] C-559

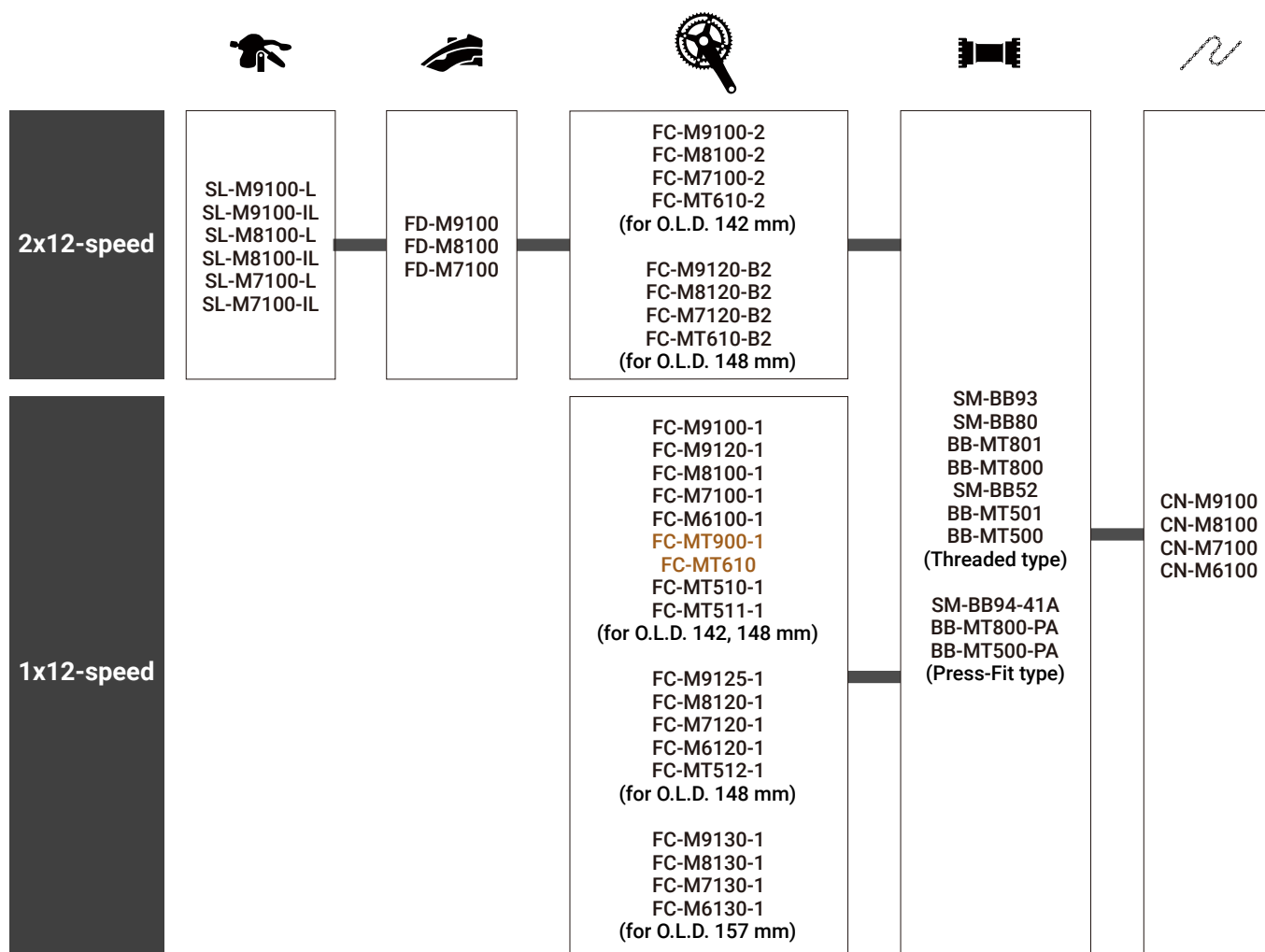

11-speed front drivetrain [MTB, LIFESTYLE] C-441

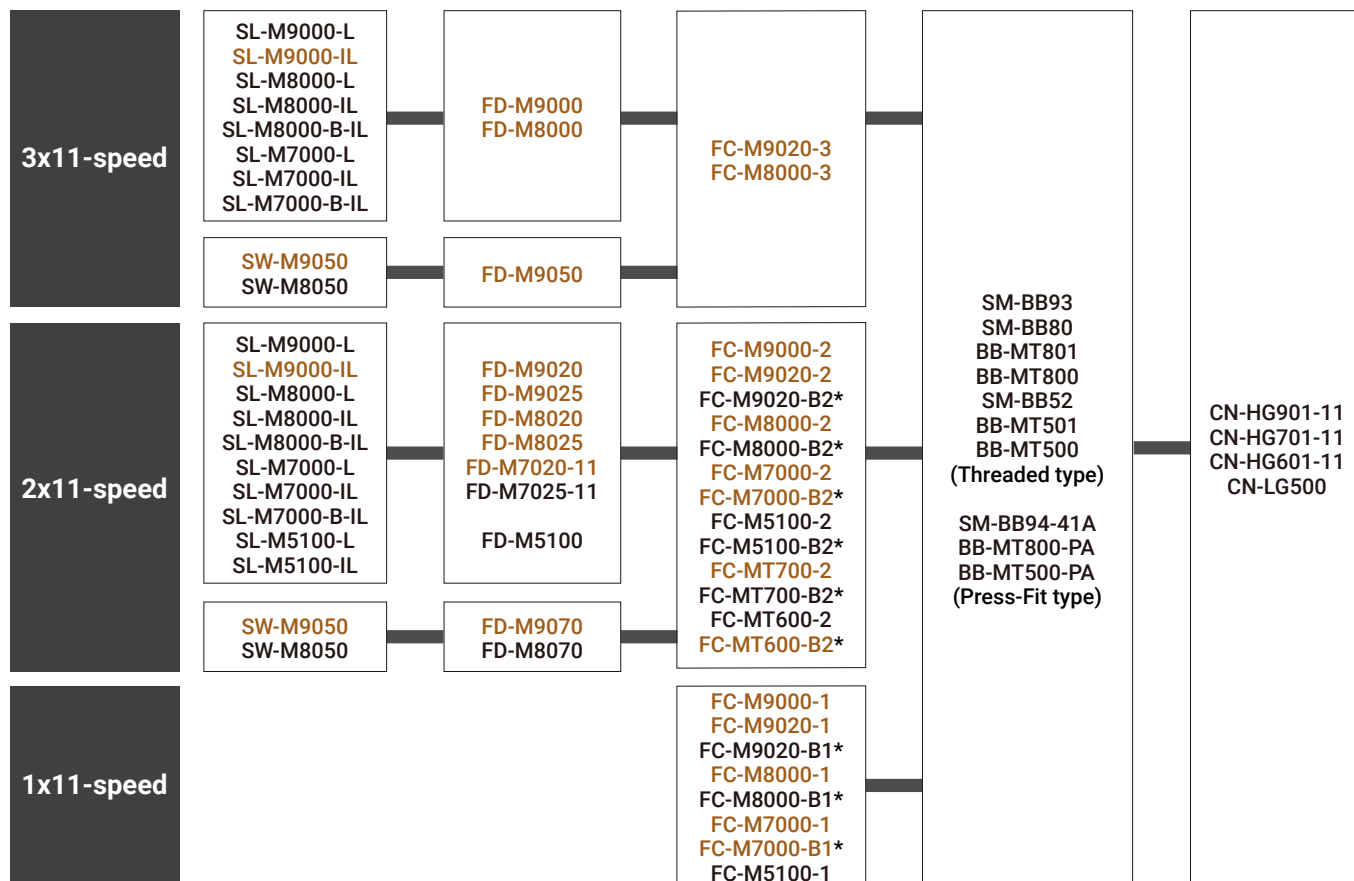



**LINKGLIDE
2x11-speed**

SL-U8000-L
SL-U8000-IL
SL-U6000-L
SL-U4000-L

FD-U8010-L
(For 46-32T
at 11-speed)
FD-U6010-L
(For 40-26T/46-32T
at 11-speed)

FD-U6010-L
(For 40-26T/46-32T
at 11-speed)
FD-U6000-D
FD-U6000-E
FD-U6000-M
(For 36-22T/40-26T)

FC-U8000-2
FC-U6010-2

FC-U6000-2
FC-U6000-2B
FC-U4010-2B
(36-22T)
FC-U4010-2
(36-22T/40-26T)

FC-U4000-2
(36-22T/40-26T)
FC-U4000-2B
(36-22T)

SM-BB93
SM-BB80
BB-MT800
SM-BB52
BB-MT500
(Threaded type)

BB-MT801
BB-MT501
BB-UR400
(Threaded type)
SM-BB94-41A
BB-MT800-PA
BB-MT500-PA
(Press-Fit type)

BB-UN55
BB-UN26
BB-UN101
BB-UN300
(Square type)

CN-HG901-11
CN-HG701-11
CN-HG601-11
CN-LG500

**LINKGLIDE
1x11-speed**

FC-U8000-1

FC-U6000-1

FC-U4000-1

SM-BB93
SM-BB80
BB-MT800
SM-BB52
BB-MT500
(Threaded type)

BB-MT801
BB-MT501
BB-UR400
(Threaded type)
SM-BB94-41A
BB-MT800-PA
BB-MT500-PA
(Press-Fit type)

BB-UN55
BB-UN26
BB-UN101
BB-UN300
(Square type)

10-speed front drivetrain [MTB, Trekking, LIFESTYLE] C-442

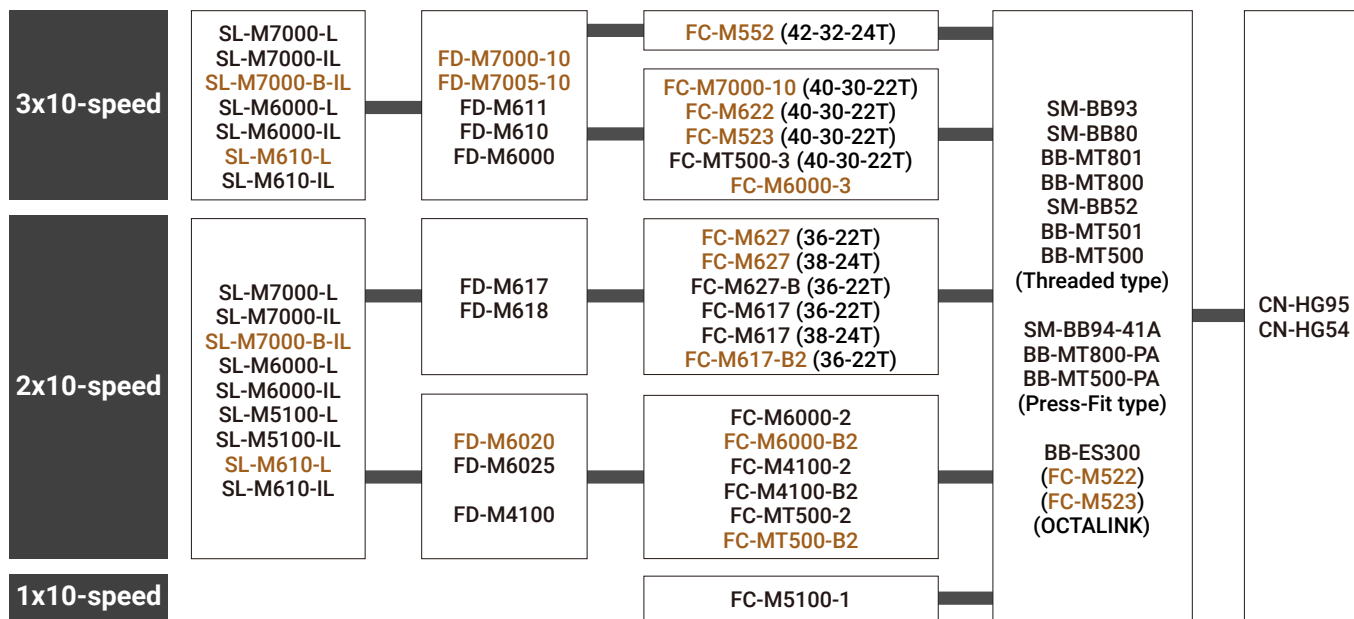



**3x10-speed
Trekking**

SL-T8000-L
SL-T780-L
SL-M780-L
SL-M780-B-IL
SL-T670-L
SL-M670-L
SL-M670-B-IL
SL-T610-L
SL-M610-L
SL-M610-IL
SL-M591-L
SL-T6000-L

FD-T8000-3
FD-T8000-6
FD-T780-3
FD-T780-6
FD-T781-3
FD-T670-3
FD-T670-6
FD-T671-3
FD-T610-3
FD-T610-6
FD-T611-3
FD-T6000-3
FD-T6000-6

FC-T8000 (48-36-26T)
FC-T780 (48-36-26T)
FC-T781 (44-32-24T)
FC-T781 (48-36-26T)
FC-T671 (44-32-24T)
FC-T671 (48-36-26T)
FC-M610 (48-36-26T)
FC-M670 (48-36-26T)
FC-T611 (44-32-24T)
FC-T611 (48-36-26T)
FC-T6010 (44-32-24T)
FC-T6010 (48-36-26T)
FC-T551 (44-32-24T)
FC-T551 (48-36-26T)
FC-T521 (44-32-24T)
FC-T521 (48-36-26T)

SM-BB93
BB-MT801
BB-MT800
SM-BB52
BB-MT501
BB-MT500
(Threaded type)

SM-BB94-41A
BB-MT800-PA
BB-MT500-PA
(Press-Fit type)

BB-ES300
(FC-T521)
(OCTALINK)

CN-M981
CN-M980
CN-HG95
CN-HG94
CN-HG75
CN-HG74
CN-HG54

**LINKGLIDE
2x10-speed**

SL-U8000-L
SL-U8000-IL
SL-U6000-L
SL-U4000-L

FD-U8010-L
(For 46-30T
at 10-speed)
FD-U6010-L
(For 46-30T
at 10-speed)

FD-U6000-D
FD-U6000-E
FD-U6000-M
FD-U4000-L
FD-U4000-D
FD-U4000-E
FD-U4000-M
(For 36-22T/40-26T)

FC-U6000-2
FC-U4010-2
(46-30T)

FC-U6000-2
FC-U6000-2B
FC-U4010-2B
(36-22T)

FC-U4010-2
(36-22T/40-26T)

FC-U4000-2
(36-22T/40-26T)
FC-U4000-2B
(36-22T)

BB-MT801
BB-MT501
BB-UR400
(Threaded type)

SM-BB94-41A
BB-MT800-PA
BB-MT500-PA
(Press-Fit type)

BB-UN55
BB-UN26
BB-UN101
BB-UN300
(Square type)

CN-HG901-11
CN-HG701-11
CN-HG601-11
CN-LG500

**LINKGLIDE
1x10-speed**

FC-U8000-1

FC-U6000-1

FC-U4000-1

SM-BB93
SM-BB80
BB-MT800
SM-BB52
BB-MT500
(Threaded type)

BB-MT801
BB-MT501
BB-UR400
(Threaded type)

SM-BB94-41A
BB-MT800-PA
BB-MT500-PA
(Press-Fit type)

BB-UN55
BB-UN26
BB-UN101
BB-UN300
(Square type)

9-speed front drivetrain [MTB, LIFESTYLE] C-445

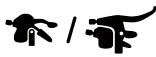

3x9-speed

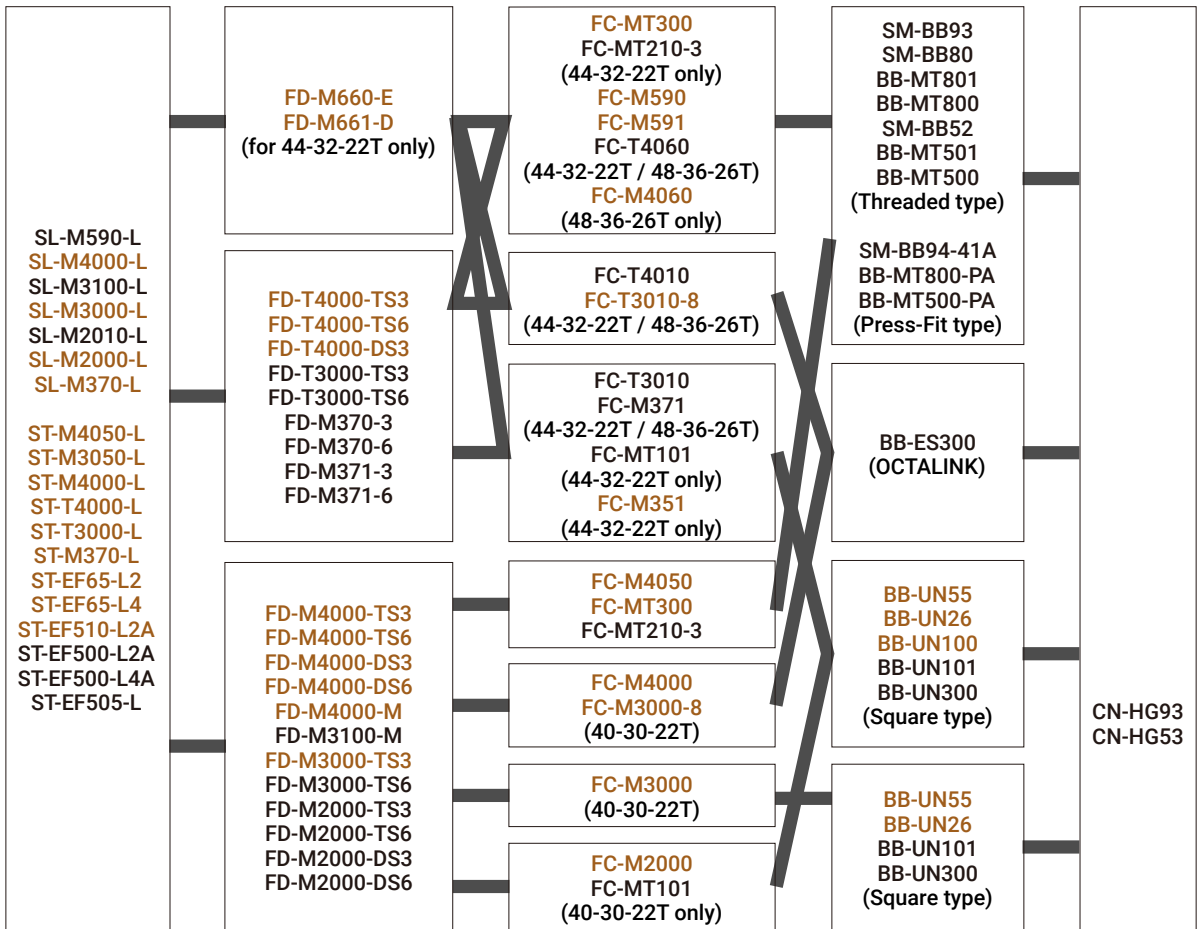

2x9-speed

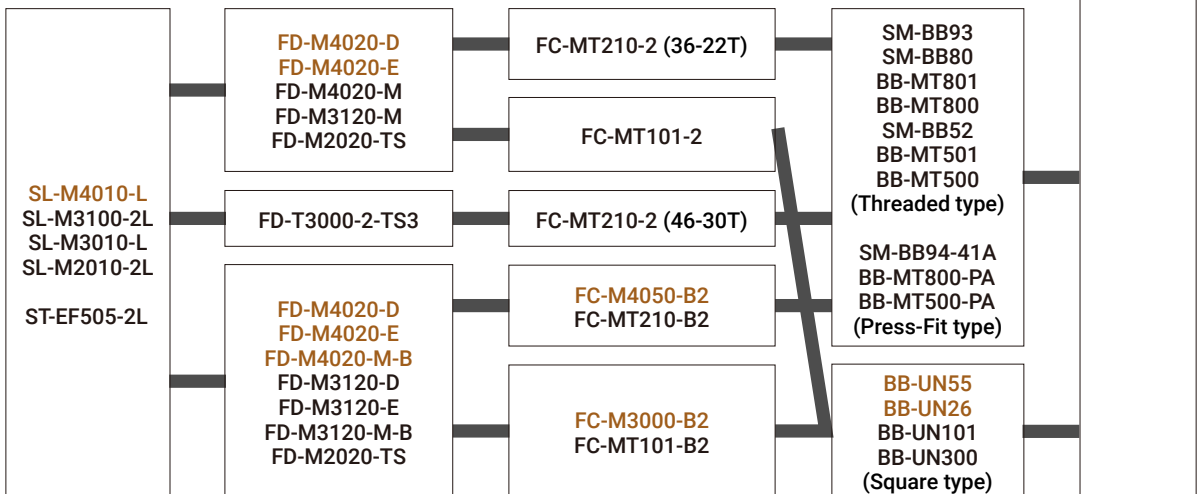

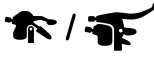

**LINKGLIDE
2x9-speed**

SL-U8000-L
SL-U8000-IL
SL-U6000-L
SL-U4000-L

FD-U4010-L
(For 46-30T)

FD-U4000-L
FD-U4000-D
FD-U4000-E
FD-U4000-M
(For 36-22T/40-26T)

FC-U6000-2
FC-U4010-2
(46-30T)

FC-U6000-2
FC-U6000-2B
FC-U4010-2B
(36-22T)

FC-U4010-2
(36-22T/40-26T)

FC-U4000-2
(36-22T/40-26T)
FC-U4000-2B
(36-22T)

BB-MT801
BB-MT501
BB-UR400
(Threaded type)

SM-BB94-41A
BB-MT800-PA
BB-MT500-PA
(Press-Fit type)

BB-UN55
BB-UN26
BB-UN101
BB-UN300
(Square type)

CN-HG901-11
CN-HG701-11
CN-HG601-11
CN-LG500

**LINKGLIDE
1x9-speed**

FC-U8000-1

FC-U6000-1

FC-U4000-1

SM-BB93
SM-BB80
BB-MT800
SM-BB52
BB-MT500
(Threaded type)

BB-MT801
BB-MT501
BB-UR400
(Threaded type)

SM-BB94-41A
BB-MT800-PA
BB-MT500-PA
(Press-Fit type)

BB-UN55
BB-UN26
BB-UN101
BB-UN300
(Square type)

8,7,6-speed front drivetrain [MTB, LIFESTYLE] C-446

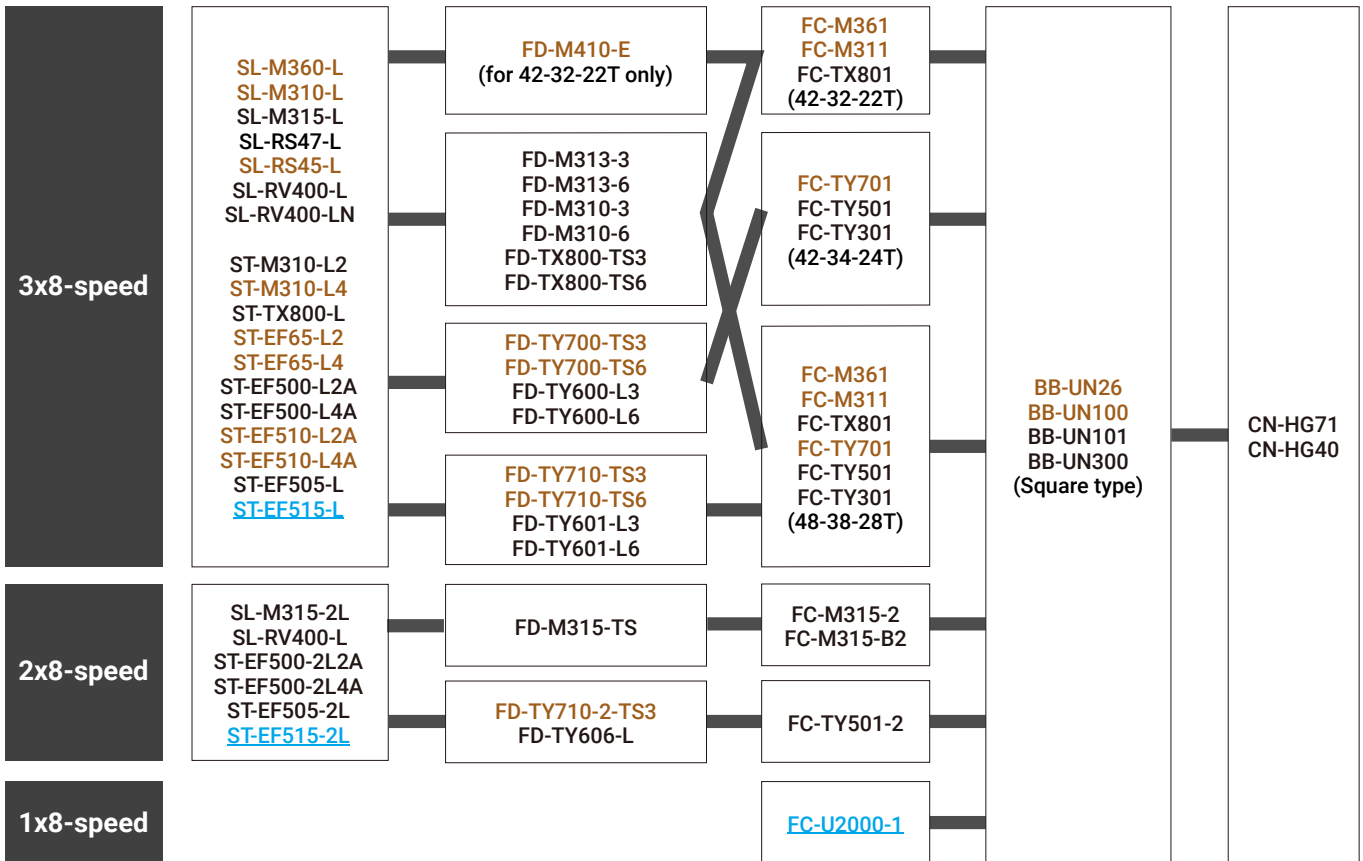
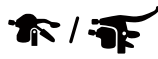

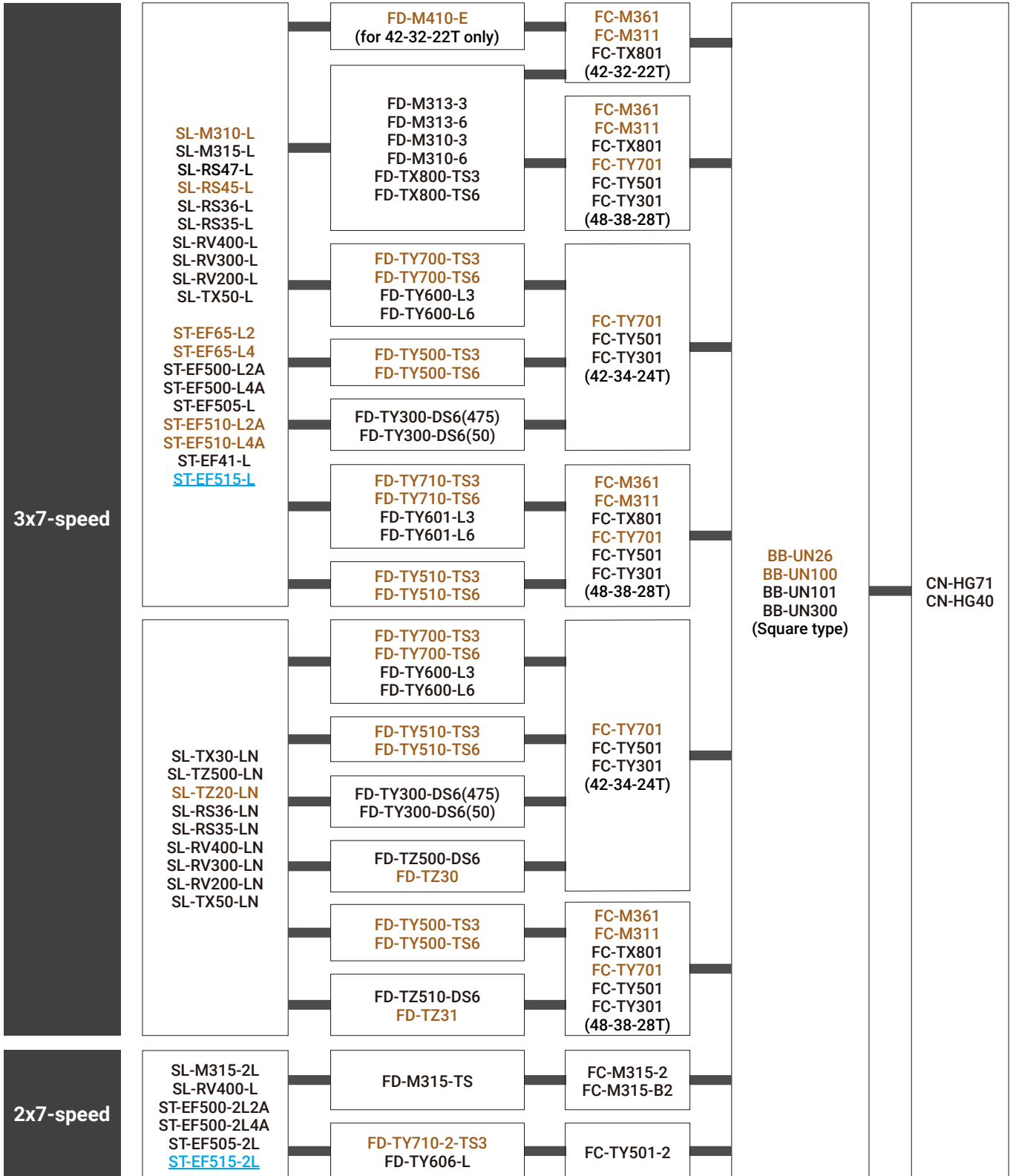
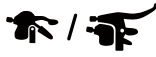

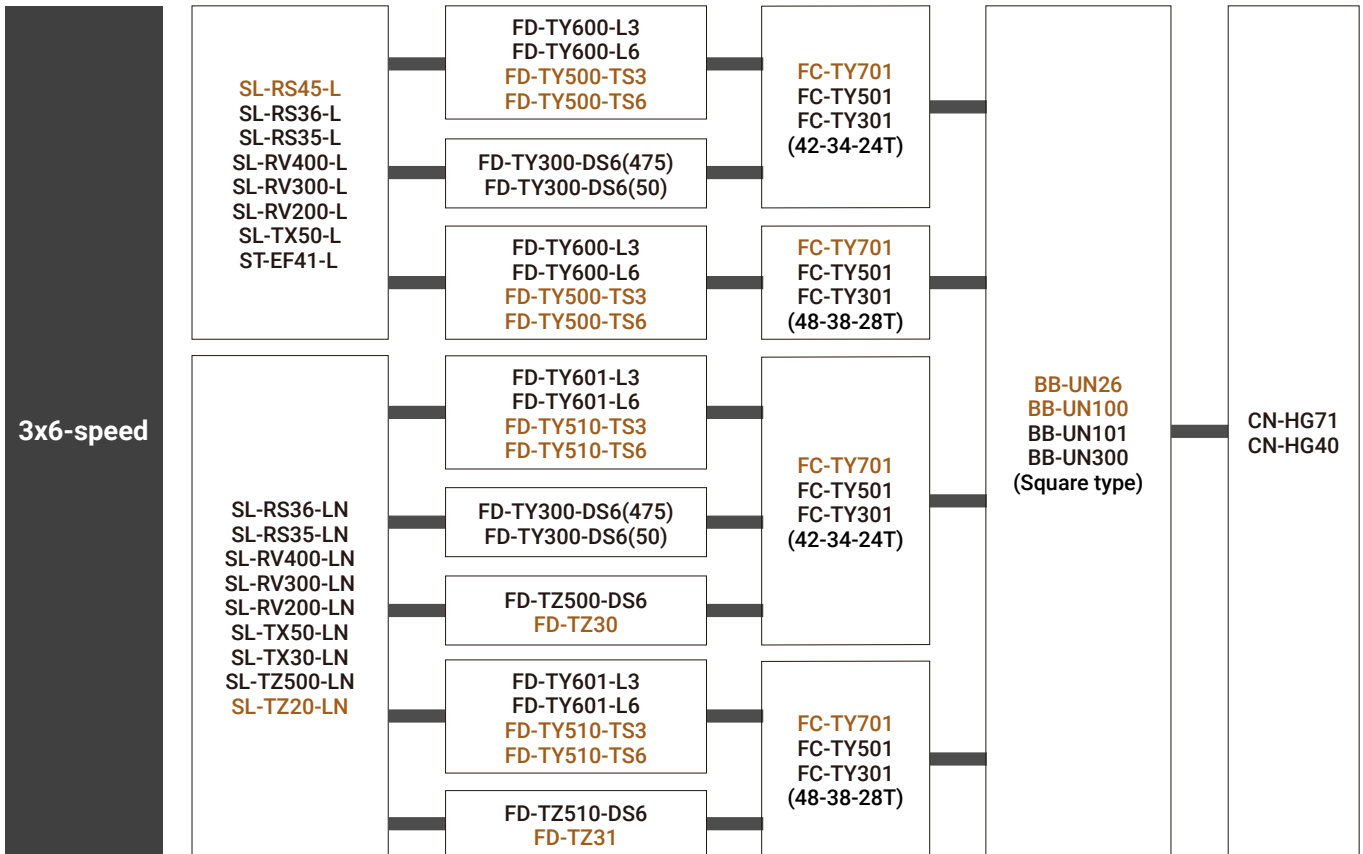
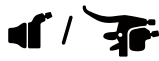

Front derailleur and crankset

C-447

The allowable combinations of front derailleurs depend on the difference in the number of teeth of the gears and the shape of the front derailleur plate.

If the conditions given below are not satisfied, then the desired shiftability may not be obtained.

$$FC \text{ (largest chainring) - (smallest chainring)} \leq FD \text{ (high and low capacity)}$$

$$FC \text{ (largest chainring) - (middle chainring)} = FD \text{ (allowance of difference in teeth number between top and middle)}$$

Each front derailleurs and the number of teeth of corresponding cranksets are given in the compatibility chart.

Front derailleur and chain line (TOURNEY)

C-448

The SHIMANO line-up for front derailleurs and the chain lines they support are given in the chart below.

Chain line (mm)		28.6 mm (S)	31.8 mm (M)	34.9 mm (L)
		FD-TY300-DS6(475)		47.5
	FD-TY300-DS6(50)		-	50.0
	FD-TZ510-DS6 FD-TZ500-DS6 FD-TZ31 FD-TZ30		47.5	-
	FD-TY600-L3 FD-TY600-L6	-	47.5 50	47.5 50
	FD-TY601-L3 FD-TY601-L6	-	47.5 50	47.5 50

Crankset, bottom bracket and chain line [MTB, LIFESTYLE]

C-449

In order to use SIS (SHIMANO INDEX SYSTEM) to its full extent, the required correct chain line, along with the crankset and bottom bracket required to obtain that, are given in the chart below.

Separate type FC-BB compatibility [MTB, LIFESTYLE] C-450

11, 10, 9-speed

Speed	Series	Crankset				Bottom bracket Model No.	Chain line and axle mark						
		Model No.	Type of crank				47.5 mm	50.0 mm	52.5 mm	47.5+t mm	48.8 mm	51.8 mm	52 mm
			OCTALINK	Square	Chain case								
11, 10, 9	CUES	FC-U4000-1 (40T/42T)	-	✓	✓*1	BB-UN300(-K) BB-UN101(-K)	-	LL123	-	-	-	-	-
		FC-U4000-1 (30T/32T)	-	✓	-	BB-UN300 BB-UN101	-	-	-	-	-	-	LL123
		FC-U4000-2	-	✓	-	BB-UN300 BB-UN101	-	-	-	-	LL123	-	-
		FC-U4000-2B	-	✓	-	BB-UN300 BB-UN101	-	-	-	-	-	LL123	-
10	SHIMANO	FC-M523	✓	-	-	BB-ES300	-	118	-	-	-	-	-
		FC-M522	✓	-	-	BB-ES300	-	113	-	-	-	-	-
9	ALIVIO	FC-M4000	✓	-	-	BB-ES300	-	118	-	-	-	-	-
		FC-T4010	✓	-	✓*1	BB-ES300(-K)	-	126	-	-	-	-	-
		FC-M430-8	✓	-	-	BB-ES300(-E)	-	118	-	-	-	-	-
		FC-M430	-	✓	-	BB-UN26(-E) BB-UN300(-E)	-	LL113	-	-	-	-	-
	ACERA	FC-M3000-8	✓	-	-	BB-ES300	-	118	-	-	-	-	-
		FC-M3000 FC-M3000-B2	-	✓	-	BB-UN26 BB-UN300	-	LL113	-	-	-	-	-
		FC-T3010-8	✓	-	✓*1	BB-ES300(-K)	-	126	-	-	-	-	-
	SHIMANO	FC-T3010	-	✓	✓*1	BB-UN26(-K) BB-UN300(-K)	-	LL123	-	-	-	-	-
		ALTUS	FC-M2000	-	✓	-	BB-UN26 BB-UN300 BB-UN100 BB-UN101	-	LL123	-	-	-	-
	SHIMANO		FC-MT100 FC-MT101	-	✓	-	BB-UN26 BB-UN300 BB-UN100 BB-UN101	-	LL123	-	-	-	-
		FC-M371 FC-M351	-	✓	✓*1	BB-UN26(-K) BB-UN300(-K)	-	LL123	-	-	-	-	-

*1 Chain case stay thickness should be 1.5 mm to 2.1 mm.

NOTE

- If using a chain case, select a BB-xxxx (-K) / -K bottom bracket.
- If using an E-type front derailleur, select a BB-xxxx (-E) bottom bracket.
- **FC-M521**: Use 121AK with 1.8 mm spacer if no chain case used.

8, 7, 6-speed

Speed	Series	Crankset				Bottom bracket	Chain line and axle mark						
		Model No.	Type of crank				Model No.	47.5 mm	50.0 mm	52.5 mm	47.5+t mm	48.8 mm	51.8 mm
			OCTALINK	Square	Chain case								
8, 7	ACERA ALTUS	FC-M361 FC-M311	–	✓	✓*1	BB-UN26(-K) BB-UN300(-K)	–	LL123	–	–	–	–	–
	TOURNEY	FC-TX801	–	✓	✓*1	BB-UN26(-K) BB-UN300(-K) BB-UN100(-K) BB-UN101(-K)	–	LL123	–	–	–	–	–
	SHIMANO	FC-M315-2	–	✓	–	BB-UN26 BB-UN300 BB-UN100 BB-UN101	–	–	–	–	LL123	–	–
		FC-M315-B2	–	✓	–	BB-UN26 BB-UN300 BB-UN100 BB-UN101	–	–	–	–	–	LL123	–
		FC-TY501-2	–	✓	–	BB-UN26 BB-UN300 BB-UN100 BB-UN101	–	–	–	–	LL123	–	–
8, 7, 6	SHIMANO ESSA	FC-J2000-1 (40T)	–	✓	✓*1	BB-UN300(-K) BB-UN101(-K)	–	LL123	–	–	–	–	–
		FC-J2000-1 (32T)	–	✓	–	BB-UN300 BB-UN101	–	–	–	–	–	–	LL123
	SHIMANO	FC-TY701 FC-TY501 FC-TY301	–	✓	✓	BB-UN26(-K) BB-UN300(-K) BB-UN100(-K) BB-UN101(-K)	D-NL (122.5)	D-EL	–	D-NL-K (122.5)	–	–	–

*1 Chain case stay thickness should be 1.5 mm to 2.1 mm.

NOTE

- If using a chain case, select a BB-xxxx (-K) / -K bottom bracket.
- If using an E-type front derailleur, select a BB-xxxx (-E) bottom bracket.

Drivetrain for ROAD, Gravel, LIFESTYLE components

C-453

Rear drivetrain compatibility

C-454

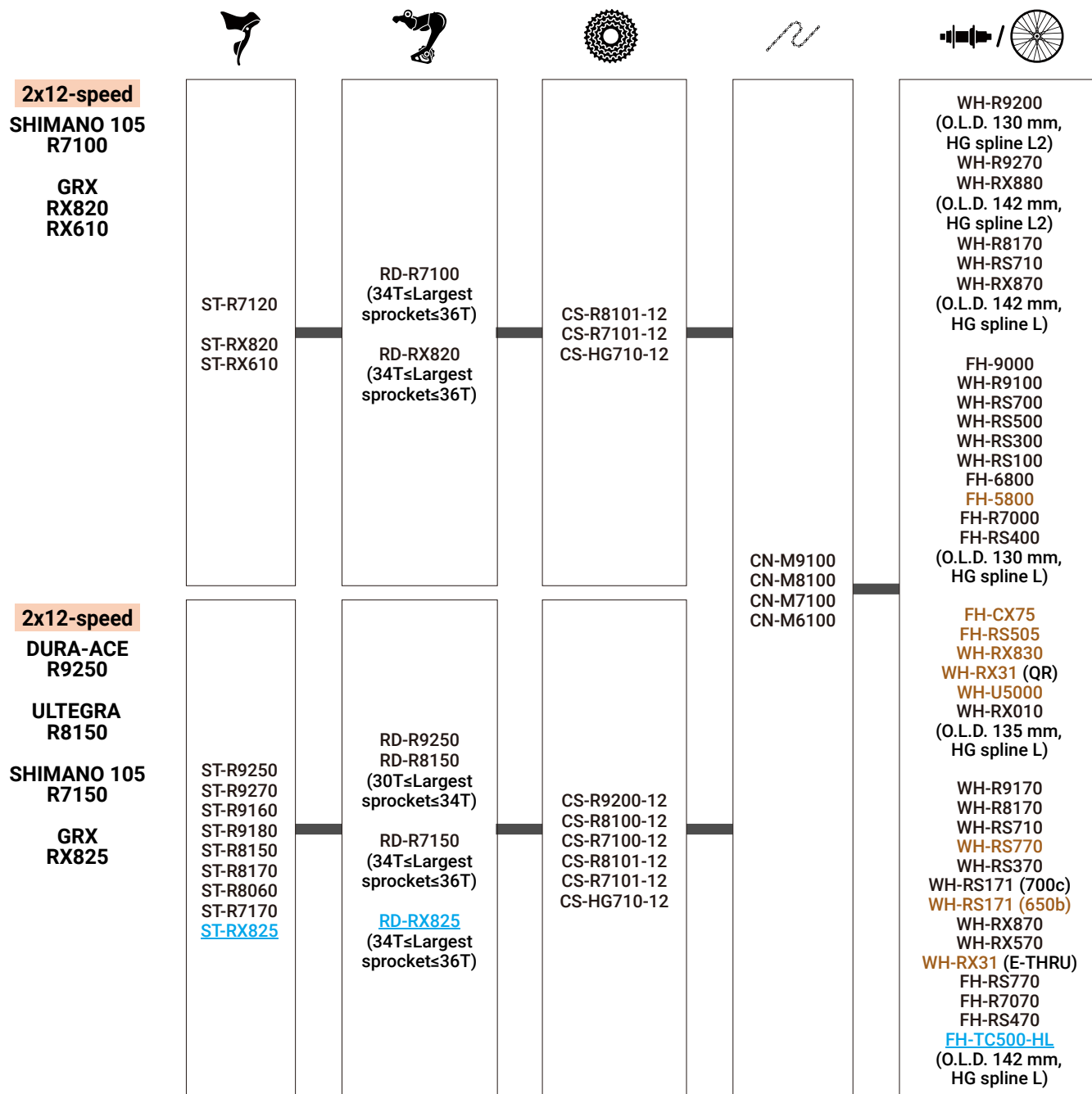

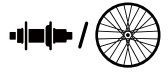

1x12-speed

**GRX
RX820
RX610**

ST-RX820
ST-RX610

RD-RX822-GS
(45T≤Largest
sprockets≤45T)

RD-RX822-SGS
(51T≤Largest
sprockets≤51T)

CS-M9101-12
CS-M9100-12
CS-M8100-12
CS-M7100-12
(10-45T)

CS-M9101-12
CS-M9100-12
CS-M8100-12
CS-M7100-12
CS-M6100-12
(10-51T)

CN-M9100
CN-M8100
CN-M7100
CN-M6100

WH-RX880
(O.L.D. 142 mm,
MICRO SPLINE)

FH-M9111
FH-M8110
FH-M7110
FH-MT500
FH-MT510
FH-MT410
FH-TC500-MS
(O.L.D. 142 mm,
MICRO SPLINE)

FH-MT401
(O.L.D. 135 mm,
MICRO SPLINE)

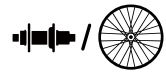

2x11-speed

**DURA-ACE
R9100
9000**

**ULTEGRA
R8000
6800**

**SHIMANO 105
R7000
5800**

**METREA
U5000**

**GRX
RX810
RX600**

ST-R9100
ST-R9120
ST-9001
ST-9000
SL-BSR1
ST-R8000
ST-R8020
ST-R8025
ST-6800
ST-R7000
ST-R7020
ST-R7025
ST-5800

SL-RS700
ST-RS685
ST-RS505

ST-U5060
SL-U5000
ST-RX810
ST-RX600

ST-R9150
ST-R9160
ST-R9170
ST-R9180
ST-9070
ST-R8050
ST-R8060
ST-R8070
ST-9071

ST-6870
ST-6871
ST-RX815
ST-R785

RD-R9100-SS
RD-R8000-SS
(25T≤Largest sprockets≤30T)

RD-R8000-GS
RD-RX800-GS
(28T≤Largest sprockets≤34T)

RD-9000
RD-6800-SS
RD-5800-SS
(23T≤Largest sprockets≤28T)

RD-R7000-SS
(25T≤Largest sprockets≤30T)

RD-R7000-GS
(28T≤Largest sprockets≤34T)

RD-6800-GS
RD-5800-GS
(28T≤Largest sprockets≤32T)

RD-U5000-SS
(28T≤Largest sprockets≤32T)

RD-RX810
(30T≤Largest sprockets≤34T)

RD-RX800
(28T≤Largest sprockets≤34T)

RD-R9150-SS
RD-R8050-SS
(25T≤Largest sprockets≤30T)

RD-9070-SS
RD-6870-SS
(23T≤Largest sprockets≤28T)

RD-R8050-GS
RD-RX805
(28T≤Largest sprockets≤34T)

RD-6870-GS
(28T≤Largest sprockets≤32T)

RD-RX815
(30T≤Largest sprockets≤34T)

CS-R9100

CS-9000
CS-6800
CS-5800
CS-R8000
CS-HG800-11
CS-R7000
CS-HG700-11

CN-9000

CN-6800
CN-HG901-11
CN-HG701-11
CN-HG601-11

CN-LG500

FH-9000
WH-R9100
WH-RS700
WH-RS500
WH-RS300
WH-RS100
FH-6800
FH-5800
FH-R7000
FH-RS400
(O.L.D. 130 mm)

FH-CX75
FH-RS505
WH-RX830
WH-RX31 (QR)
WH-U5000
WH-RX010
(O.L.D. 135 mm)

WH-R9170
WH-R8170
WH-RS710
WH-RS770
WH-RS370
WH-RS171 (700c)
WH-RS171 (650b)
WH-RX870
WH-RX570
WH-RX31 (E-THRU)
FH-RS770
FH-R7070
FH-RS470
FH-TC500-HL
(O.L.D. 142 mm)

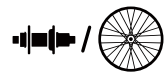

1x11-speed

METREA
U5000

ST-U5060
SL-U5000

RD-U5000-SS

CS-R9100
CS-9000
CS-6800
CS-5800
CS-R8000
CS-HG800-11
CS-R7000
CS-HG700-11

GRX
RX810
RX600

ST-R9100
ST-R9120
ST-9001
ST-9000
SL-BSR1
ST-R8000
ST-R8020
ST-R8025
ST-6800
ST-R7000
ST-R7020
ST-R7025
ST-5800

RD-RX812
(40T≤Largest
sprockets≤42T)

CS-M8000-11
CS-M7000-11
CS-M5100-11

SL-RS700
ST-RS685
ST-RS505

ST-U5060
SL-U5000
ST-RX810
ST-RX600

CN-9000

CN-6800
CN-HG901-11
CN-HG701-11
CN-HG601-11

CN-LG500

FH-9000
WH-R9100
WH-RS700
WH-RS500
WH-RS300
WH-RS100
FH-6800
FH-5800
FH-R7000
FH-RS400
(O.L.D. 130 mm)

FH-CX75
FH-RS505
WH-RX830
WH-RX31 (QR)
WH-U5000
WH-RX010
(O.L.D. 135 mm)

WH-R9170
WH-R8170
WH-RS710
WH-RS770
WH-RS370
WH-RS171 (700c)
WH-RS171 (650b)
WH-RX870
WH-RX570
WH-RX31 (E-THRU)
FH-RS770
FH-R7070
FH-RS470
FH-TC500-HL
(O.L.D. 142 mm)

ST-R9150
ST-R9160
ST-R9170
ST-R9180
ST-9070
ST-R8050
ST-R8060
ST-R8070
ST-9071

RD-RX817
(40T≤Largest
sprockets≤42T)

ST-6870
ST-6871
ST-RX815
ST-R785



2x10-speed

ULTEGRA
6700
SHIMANO 105
5700
TIAGRA
4700
4600
GRX
RX400

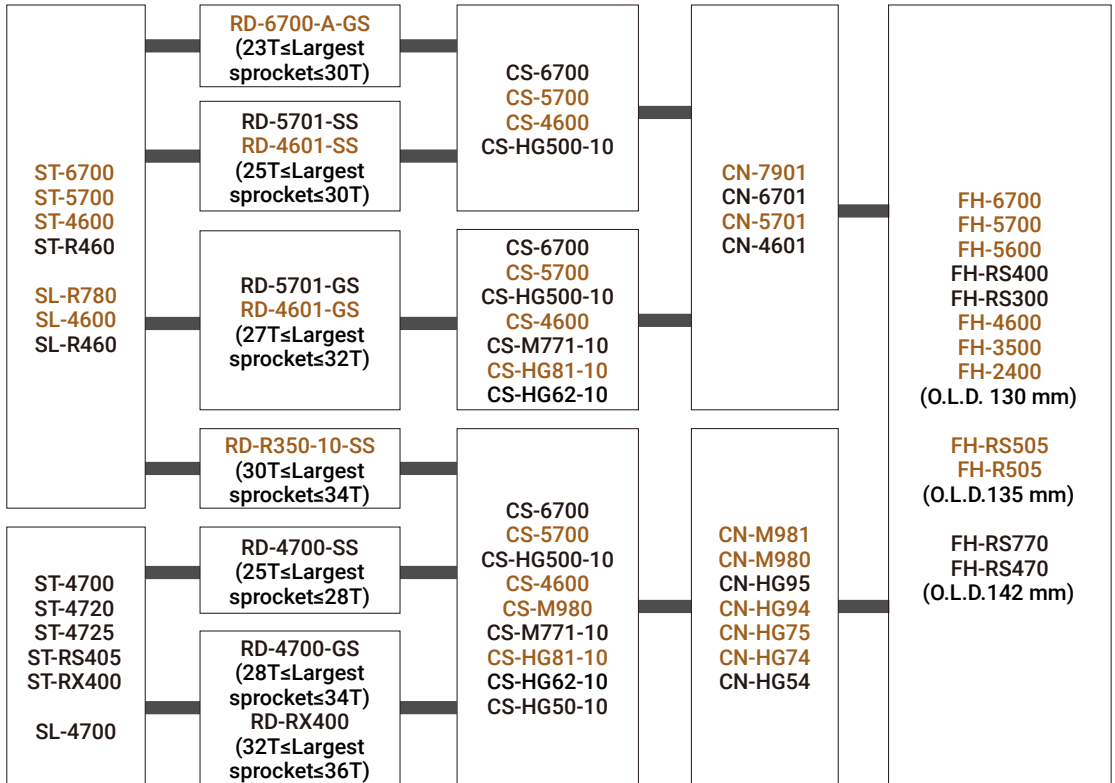

3x10-speed

ULTEGRA
6700
SHIMANO 105
5700
TIAGRA
4700
4600

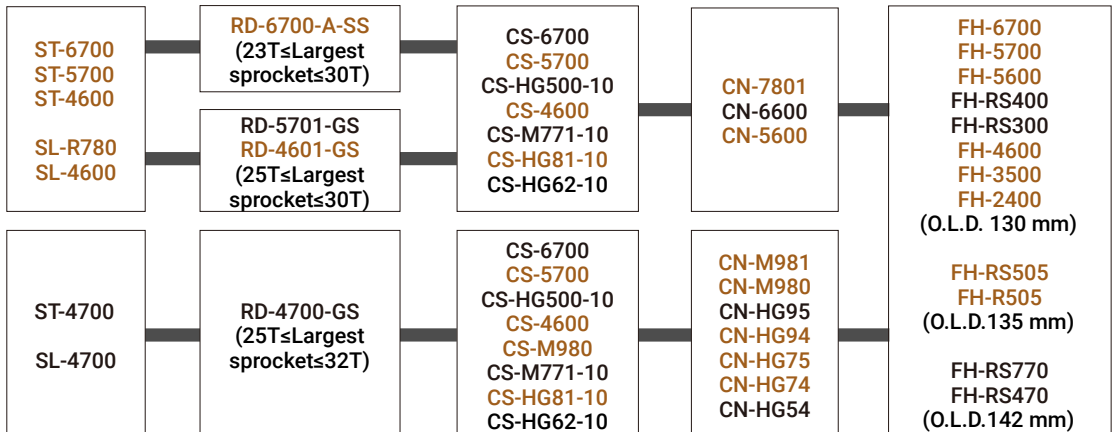



2x9-speed
SORA
R3000
3500

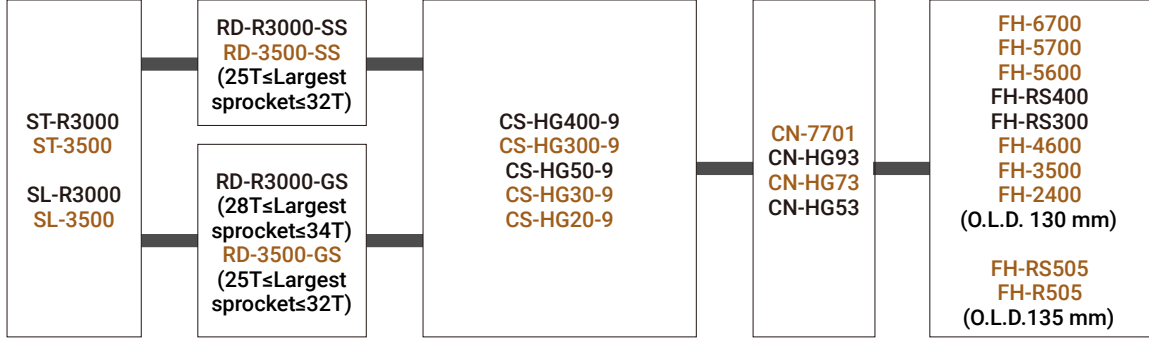

3x9-speed
SORA
3500

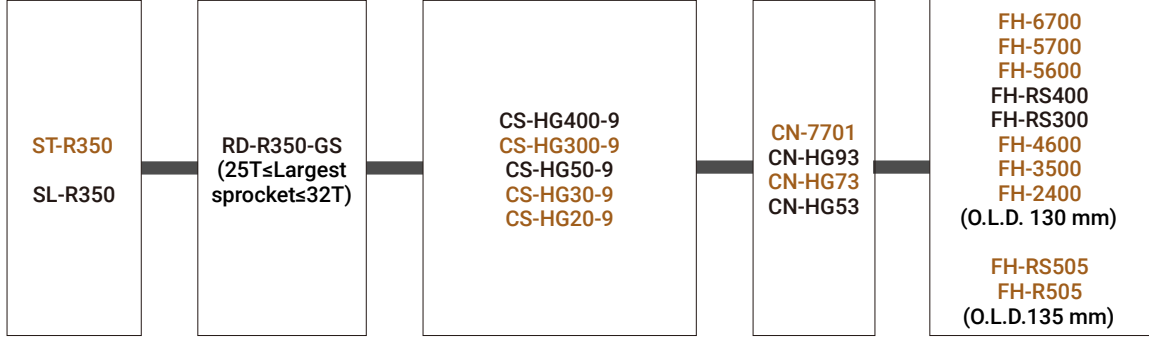

2x8-speed
CLARIS
R2000
2400

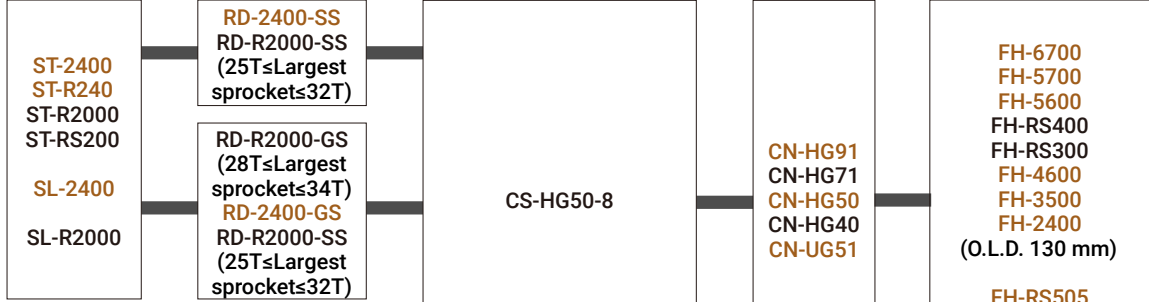

2/3x8-speed
2300



2/3x7-speed
TOURNEY
A070
A050

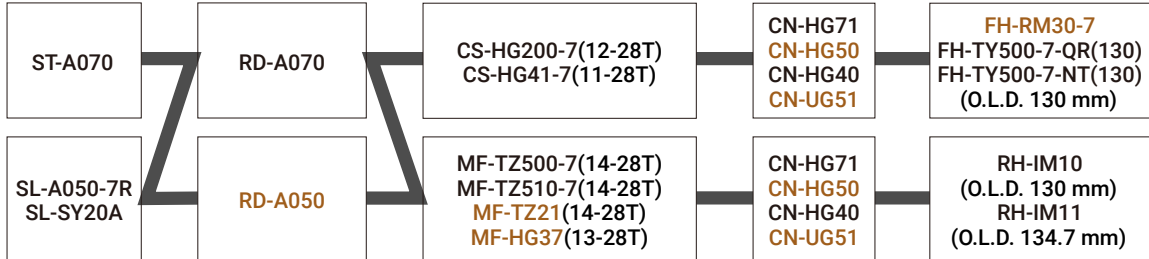

Front drivetrain compatibility

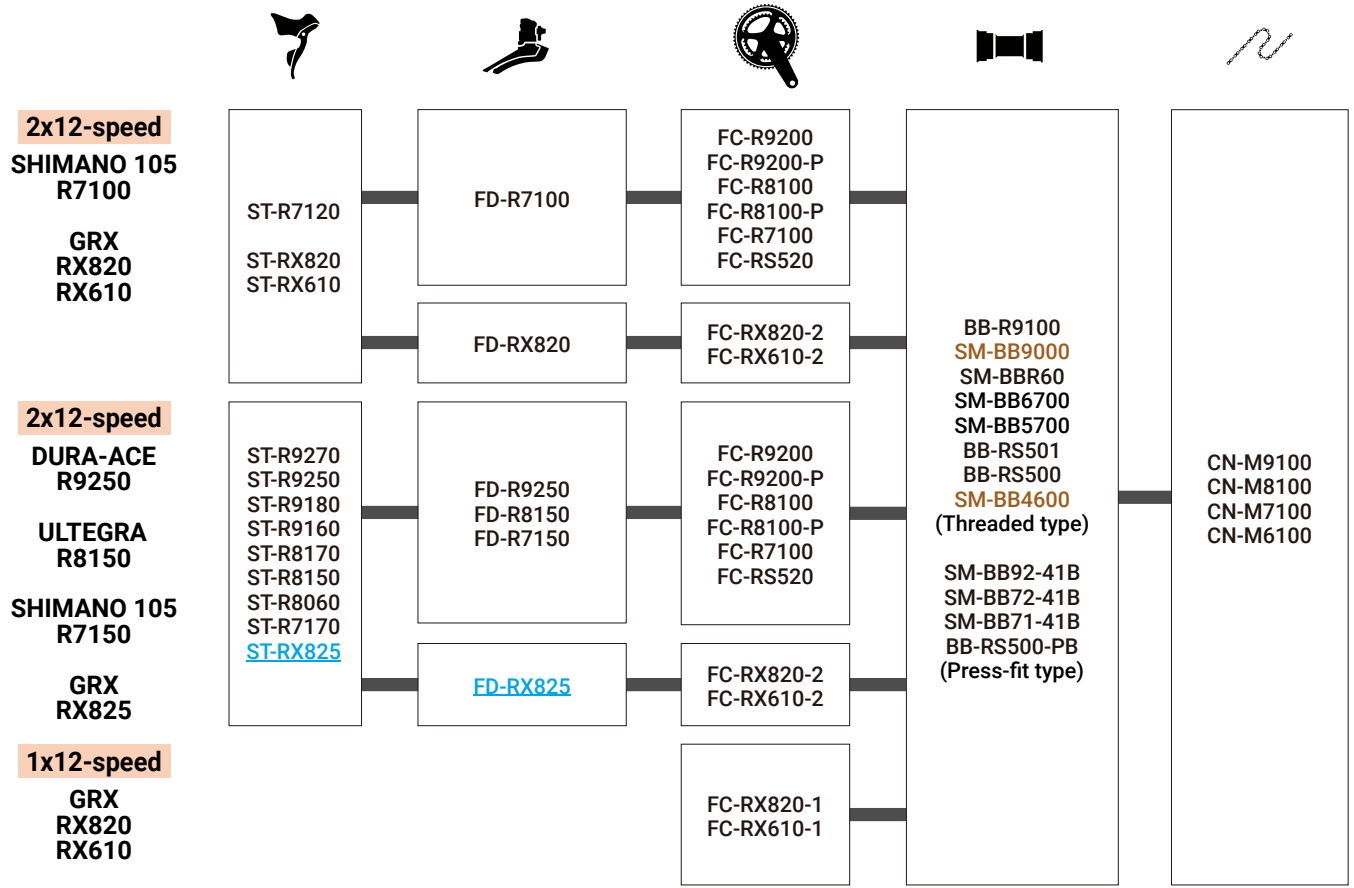



2x11-speed

DURA-ACE
R9100
9000

ULTEGRA
R8000
6800

SHIMANO 105
R7000
5800

METREA
U5000

GRX
RX810
RX600

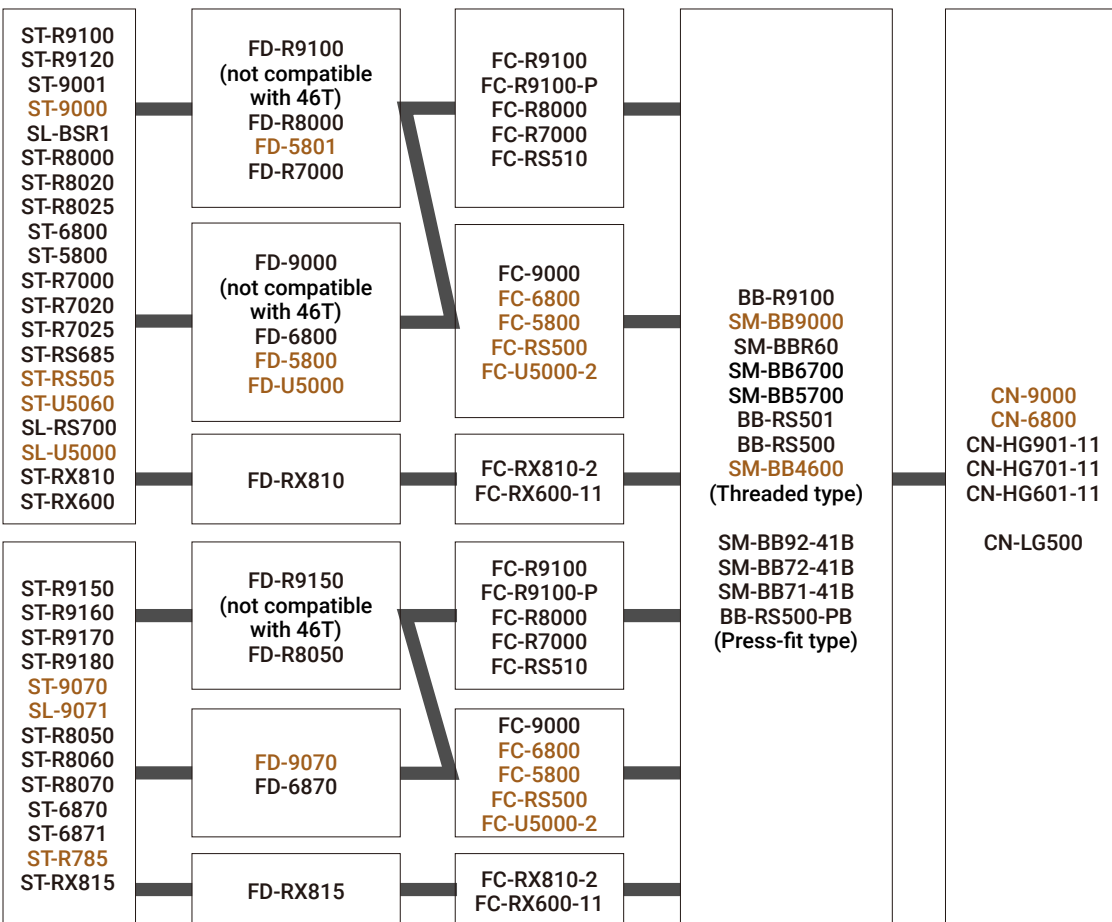

1x11-speed

GRX
RX810
RX600

METREA
U5000

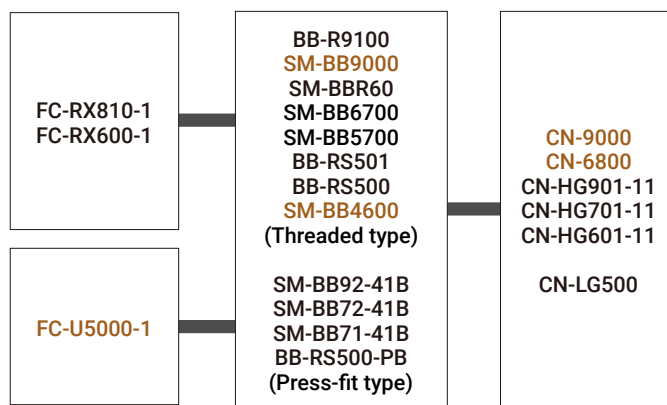



2x10-speed

**ULTEGRA
6700**

**SHIMANO 105
5700**

**TIAGRA
4700
4600**

**GRX
RX400**

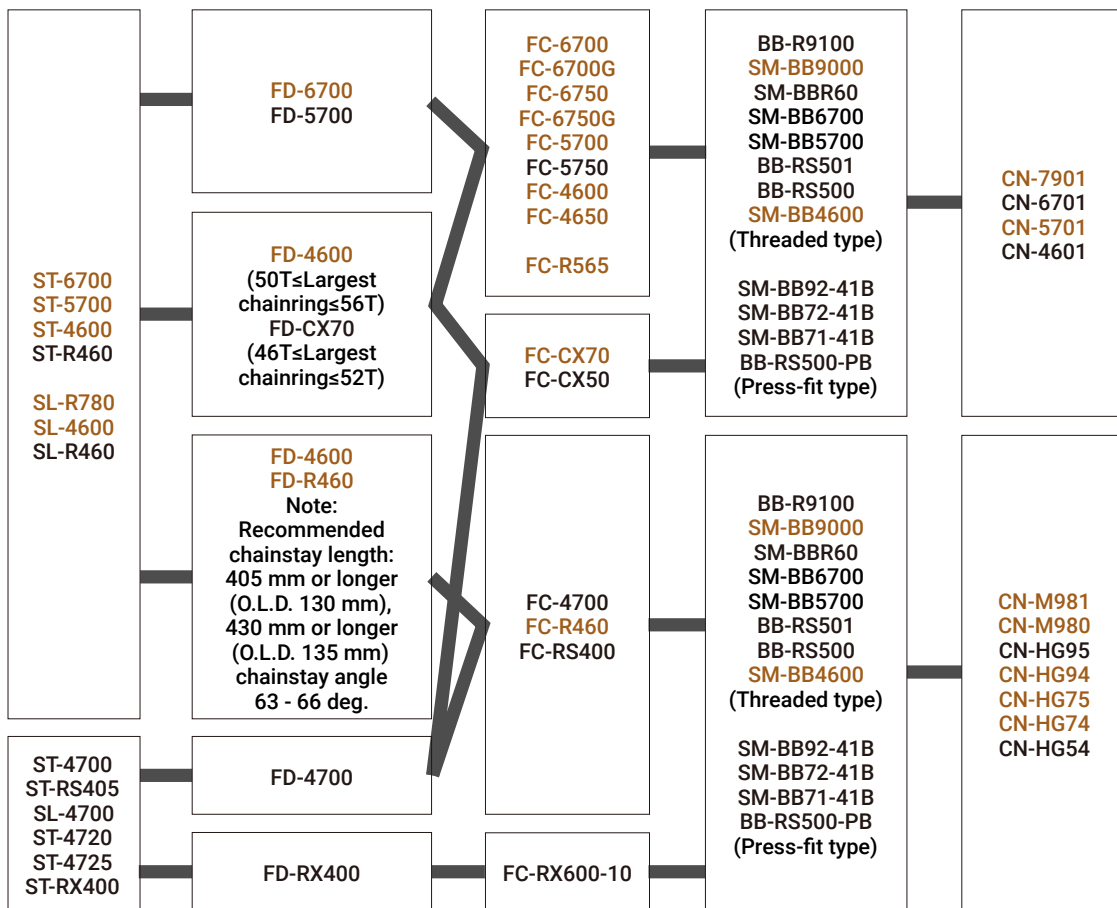

3x10-speed

**ULTEGRA
6703**

**SHIMANO 105
5703**

**TIAGRA
4703
4603**

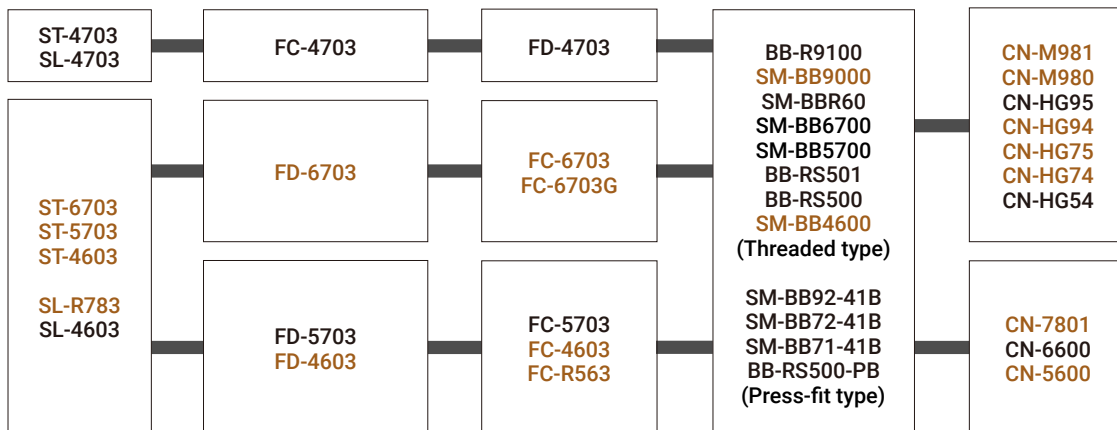



2x9-speed

**SORA
R3000
3500**

ST-3500
SL-3500

FD-3500

FC-R3000
FC-3550
FC-R350

BB-R9100
SM-BB9000
SM-BBR60
SM-BB6700
SM-BB5700
BB-RS501
BB-RS500
SM-BB4600
(Threaded type)

CN-7701
CN-HG93
CN-HG73
CN-HG53

ST-R3000
SL-R3000

FD-R3000

FC-R450
FC-R345

3x9-speed

**SORA
R3030
3500**

ST-R3030
ST-3503
ST-R353
SL-R3030
SL-3503
SL-R353

FD-R3030
FD-3503
FD-R353

FC-R3030
FC-R3030
FC-R3030
FC-3503
FC-R453

SM-BB92-41B
SM-BB72-41B
SM-BB71-41B
BB-RS500-PB
(Press-fit type)



2x8-speed

**CLARIS
R2000
2400
2300**

ST-2400
ST-2300
ST-R240
SL-2400

FD-2400
FD-2300

FC-2450

BB-ES300
BB-ES25
(OCTALINK)

CN-HG91
CN-HG71
CN-HG50
CN-HG40
CN-UG51

ST-R2000
ST-RS200
SL-R2000

FD-R2000

FC-R2000
FC-2300
FC-2350
FC-RS200

BB-R9100
SM-BB9000
SM-BBR60
SM-BB6700
SM-BB5700
BB-RS501
BB-RS500
SM-BB4600
(Threaded type)

SM-BB92-41B
SM-BB72-41B
SM-BB71-41B
BB-RS500-PB
(Press-fit type)

SL-R441
ST-R221

FD-R440A

FC-2300
FC-2350

3x8-speed

**CLARIS
R2030
2400
2300**

ST-2403
ST-2303
SL-2403
ST-R243
ST-R2030
SL-R2030
ST-RS203

FD-2403
FD-2303
FD-R2030

FC-R2030
FC-2403
FC-2303

BB-ES300
BB-ES25
(OCTALINK)

BB-UN26
BB-UN300
(Square type)

ST-R225

FD-R443A

FC-2303

2x7-speed

**TOURNEY
A070
A050**

ST-A070

FD-A070A

FC-A070 (50-34T)

SL-A050-LN
SL-SY20A

FD-A050

3x7-speed

**TOURNEY
A070**

ST-A073

FD-A073

FC-A073

Brake system for ROAD, Gravel, LIFESTYLE components

C-737

Brake systems compatibility [ROAD]

C-456

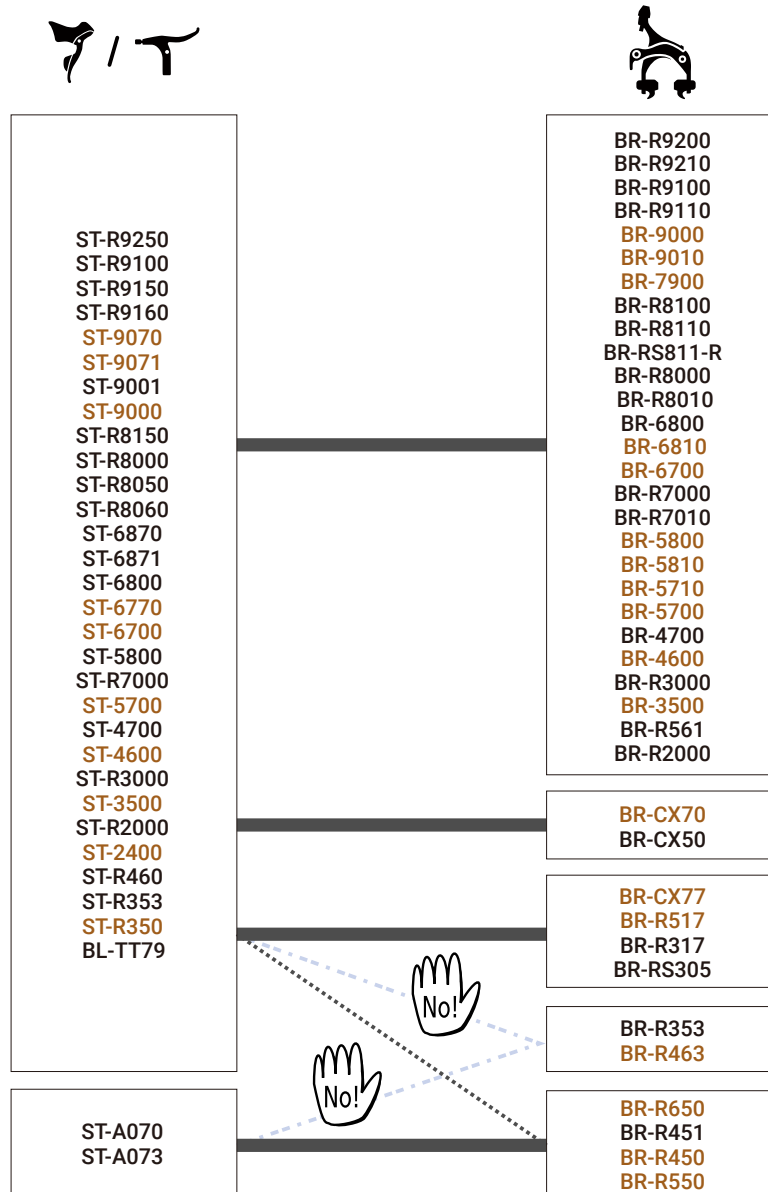

..... : Braking power is slightly less than standard combination.

 : The "NO!" symbols indicate combinations that should not be used under any circumstances.

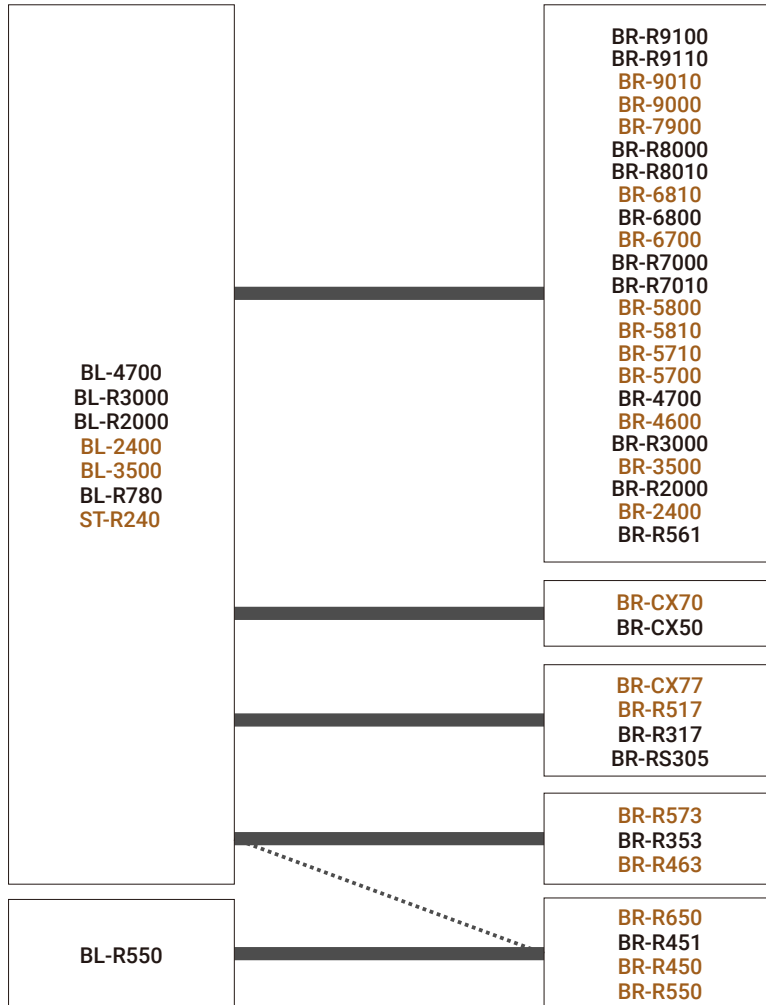

..... : Braking power is slightly less than standard combination.

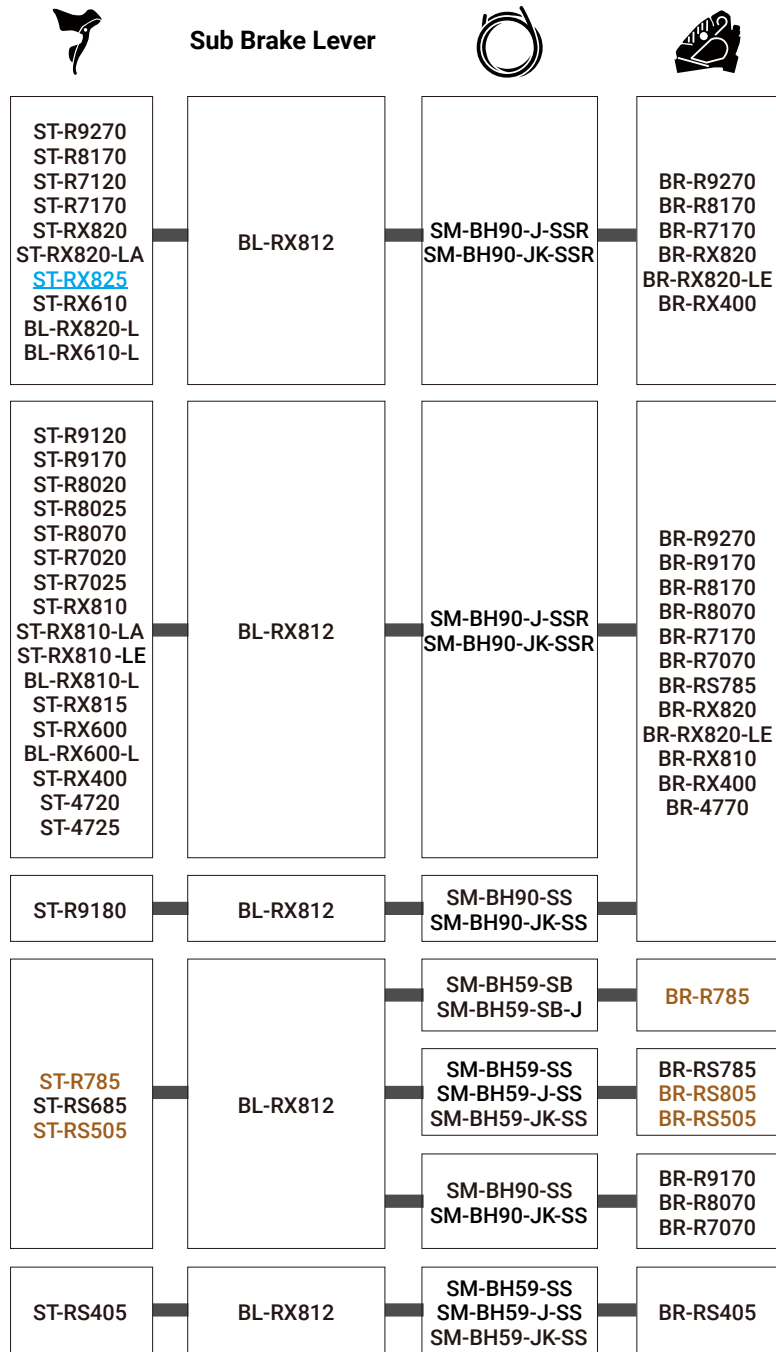

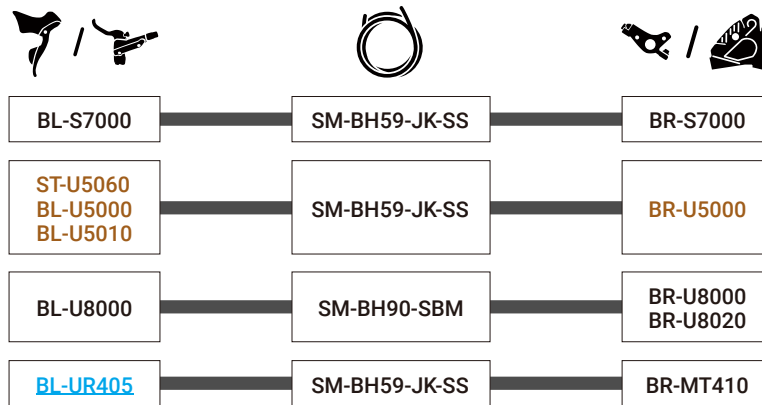

Compatibility of BL-U8000 with shifter

Shifters compatible with BL-U8000

Series	Model No.
DEORE XT	SL-M8130-R
	SL-M8100-R
SLX	SL-M7100-R
DEORE	SL-M6100-R (w/o OPTICAL GEAR DISPLAY)
	SL-M5130-R (w/o OPTICAL GEAR DISPLAY)
	SL-M5100-R (w/o OPTICAL GEAR DISPLAY)
	SL-M4100-R (w/o OPTICAL GEAR DISPLAY)
CUES	SL-U8000-L / SL-U8000-R
	SL-U8000-IL / SL-U8000-IR

BL-U8000 compatibility with shifters not listed in the table above

Clamp band type

Shifter type	Specification	Compatibility with BL-U8000
REVOSHIFT	-	Not compatible
RAPIDFIRE PLUS RAPIDFIRE PLUS MONO Thumb Shifter PLUS	w/o OPTICAL GEAR DISPLAY	*1
	w/ OPTICAL GEAR DISPLAY on top *2	Not compatible
	w/ OPTICAL GEAR DISPLAY on bottom *2	*1

I-SPEC type

Mount type	Compatibility
I-SPEC	Not compatible
I-SPEC II	*1
I-SPEC EV	Not compatible

*1 Please contact SHIMANO sales office

*2

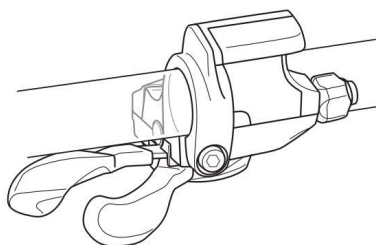

w/ OPTICAL GEAR DISPLAY on top

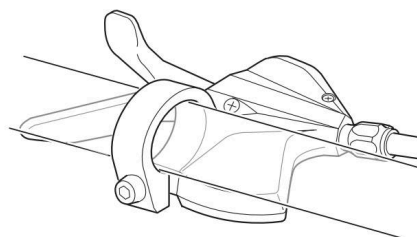

w/ OPTICAL GEAR DISPLAY on bottom

Compatibility of [BL-UR405](#) with shifter

C-755

Shifters compatible with [BL-UR405](#)

Series	Model No.
CUES	SL-U6050-11R
	SL-U6050-10R
	SL-U4050-9R

Compatibility of I-SPEC shifter and brake lever

C-157

With the exceptions noted below, clamp band type shifters are compatible as I-SPEC if the upper body is replaced with an integral unit.

- RAPIDFIRE PLUS MONO Shifter
- SL-U8000

I-SPEC EV shifter

	Model No.	SL-M9100-I	SL-M8100-I	SL-M7100-I	SL-M6100-I	SL-M5100-I	SL-M4100-I	SL-M8130-I
I-SPEC EV	BL-M9100	✓	✓	✓	✓	✓	✓	✓
	BL-M9120	✓	✓	✓	✓	✓	✓	✓
	BL-M8100	✓	✓	✓	✓	✓	✓	✓
	BL-M7100	✓	✓	✓	✓	✓	✓	✓
	BL-M6100	✓	✓	✓	✓	✓	✓	✓
	BL-M4100	✓	✓	✓	✓	✓	✓	✓
I-SPEC II	BL-M9000	-	-	-	-	-	-	-
	BL-M9020	-	-	-	-	-	-	-
	BL-M8000	-	-	-	-	-	-	-
	BL-T8100	-	-	-	-	-	-	-
	BL-T8000	-	-	-	-	-	-	-
	BL-M7000	-	-	-	-	-	-	-
	BL-M6000	-	-	-	-	-	-	-
	BL-T6000	-	-	-	-	-	-	-
	BL-RS600	-	-	-	-	-	-	-
	BL-MT500	-	-	-	-	-	-	-
	BL-MT501	-	-	-	-	-	-	-
	BL-U8000 *1	-	-	-	-	-	-	-
BL-U5000	-	-	-	-	-	-	-	
I-SPEC B	BL-M820-B	-	-	-	-	-	-	-

*1 As for the compatibility between BL-U8000 and mechanical shifter, please refer to the [C-738](#).

I-SPEC II shifter

	Model No.	SL-M9000-I	SL-M8000-I	SL-M7000-11-I SL-M7000-10-I	SL-U5000	SL-M6000-I	SL-RS700-I	SL-U8000-I
I-SPEC EV	BL-M9100	-	-	-	-	-	-	-
	BL-M9120	-	-	-	-	-	-	-
	BL-M8100	-	-	-	-	-	-	-
	BL-M7100	-	-	-	-	-	-	-
	BL-M6100	-	-	-	-	-	-	-
	BL-M4100	-	-	-	-	-	-	-
I-SPEC II	BL-M9000	✓	✓	✓	✓	✓	✓	✓
	BL-M9020	✓	✓	✓	✓	✓	✓	✓
	BL-M8000	✓	✓	✓	✓	✓	✓	✓
	BL-T8100	✓	✓	✓	✓	✓	✓	✓
	BL-T8000	✓	✓	✓	✓	✓	✓	✓
	BL-M7000	✓	✓	✓	✓	✓	✓	✓
	BL-M6000	✓	✓	✓	✓	✓	✓	✓
	BL-T6000	✓	✓	✓	✓	✓	✓	✓
	BL-RS600	✓	✓	✓	✓	✓	✓	✓
	BL-MT500	✓	✓	✓	✓	✓	✓	✓
	BL-MT501	✓	✓	✓	✓	✓	✓	✓
	BL-U8000 *1	-	-	-	-	-	-	✓
BL-U5000	✓	✓	✓	✓	✓	✓	✓	
I-SPEC B	BL-M820-B	-	-	-	-	-	-	-

*1 As for the compatibility between BL-U8000 and mechanical shifter, please refer to the [C-738](#).

I-SPEC B shifter

	Model No.	SL-M8000-B-I	SL-M7000-11 SL-M7000-10-B-I	SL-M820-B-I SL-M820 (with SM-SL82-B)
I-SPEC EV	BL-M9100	-	-	-
	BL-M9120	-	-	-
	BL-M8100	-	-	-
	BL-M7100	-	-	-
	BL-M6100	-	-	-
	BL-M4100	-	-	-
I-SPEC II	BL-M9000	-	-	-
	BL-M9020	-	-	-
	BL-M8000	-	-	-
	BL-T8100	-	-	-
	BL-T8000	-	-	-
	BL-M7000	-	-	-
	BL-M6000	-	-	-
	BL-T6000	-	-	-
	BL-RS600	-	-	-
	BL-MT500	-	-	-
	BL-MT501	-	-	-
	BL-U8000 *1	-	-	-
	BL-U5000	-	-	-
I-SPEC B	BL-M820-B	✓	✓	✓

*1 As for the compatibility between BL-U8000 and mechanical shifter, please refer to the [C-738](#).

Compatibility of seat post lever and brake lever

	Model No.	SL-MT800	SL-MT500-I
I-SPEC EV	BL-M9100	✓	✓
	BL-M9120	✓	✓
	BL-M8100	✓	✓
	BL-M7100	✓	✓
	BL-M6100	✓	✓
	BL-M4100	✓	✓
I-SPEC II	BL-M9000	-	-
	BL-M9020	-	-
	BL-M8000	-	-
	BL-T8100	-	-
	BL-T8000	-	-
	BL-M7000	-	-
	BL-M6000	-	-
	BL-T6000	-	-
	BL-RS600	-	-
	BL-MT500	-	-
	BL-MT501	-	-
	BL-U8000	-	-
	BL-U5000	-	-
I-SPEC B	BL-M820-B	-	-

Compatibility of Shift Switch and I-SPEC brake lever

C-744

For SHIMANO E-BIKE SYSTEMS switch unit, refer to [C-421](#)

I-SPEC EV type brake lever

Model No.	SW-M8150-IR	SW-M9050	SW-M8050	SW-EN605-R
BL-M9100	✓	-	-	✓
BL-M9120	✓	-	-	✓
BL-M8100	✓	-	-	✓
BL-M7100	✓	-	-	✓
BL-M6100	✓	-	-	✓
BL-M4100	✓	-	-	✓

I-SPEC II type brake lever

Model No.	SW-M8150-R	SW-M9050	SW-M8050	SW-EN605-R
BL-M9000	✓	✓	✓	✓
BL-M9020	✓	✓	✓	✓
BL-M8000	✓	✓	✓	✓
BL-T8100	✓	✓	✓	✓
BL-T8000	✓	✓	✓	✓
BL-M7000	✓	✓	✓	✓
BL-M6000	✓	✓	✓	✓
BL-T6000	✓	✓	✓	✓
BL-RS600	✓	✓	✓	✓
BL-MT500	✓	✓	✓	✓
BL-MT501	✓	✓	✓	✓
BL-U8000	✓	-	-	✓
BL-U5000	✓	✓	✓	✓

I-SPEC B type brake lever

Model No.	SW-M8150-R	SW-M9050	SW-M8050	SW-EN605-R
BL-M820-B	✓	✓	✓	✓

Other clamp band type brake lever

SW-M8150-R / SW-M9050 / SW-M8050

Model No.	SW-M8150-R	SW-M9050	SW-M8050	SW-EN605-R
BL-MT402-3A	✓	✓	✓	✓
BL-MT401	✓	✓	✓	✓
BL-MT201	✓	✓	✓	✓
BL-MT200	✓	✓	✓	✓

Disc brake caliper and rotor compatibility

C-461

Brake caliper	Brake pad material	Pad type	Rotor				
			220 mm (LL)	203 mm (L)	180 mm (M)	160 mm (S)	140 mm (SS)
BR-M9100*4 BR-M9110*5 BR-M9120*8 BR-M8100 BR-M8110*6 BR-M8120 BR-M8000 BR-M8020 BR-M7100 BR-M7110*6 BR-M7120 BR-M6100 BR-M6120 BR-MT520 BR-MT420 BR-M820 BR-U8000 BR-U8020	Metal / Resin	Narrow	SM-RT66 SM-RT64	RT-CL900 RT-CL800 RT-MT905 RT-MT900 SM-RT99 SM-RT86 SM-RT81 SM-RT76 SM-RT70 SM-RT66 SM-RT64 SM-RT70 SM-RT66 SM-RT64 SM-RT30*2 RT-EM910*1 RT-EM810*1 RT-EM600*1 RT-EM300*1*2	RT-CL900 RT-CL800 RT-MT905 RT-MT900 SM-RT99 SM-RT86 SM-RT81 SM-RT76 SM-RT70 SM-RT66 SM-RT64 SM-RT56*2 SM-RT54*2 SM-RT30*2 SM-RT26*2 SM-RT10*2 RT-EM910*1 RT-EM910*1 RT-EM900*1 RT-EM810*1 RT-EM800*1 RT-EM600*1 RT-EM300*1*2	RT-CL900 RT-CL800 RT-MT900 SM-RT900 SM-RT800 RT-MT800 SM-RT86 SM-RT81 SM-RT76 SM-RT70 SM-RT66 SM-RT64 SM-RTC60 SM-RT56*2 SM-RT54*2 SM-RT30*2 SM-RT30*2 SM-RT26*2 SM-RT10*2 RT-EM910*1 RT-EM910*1 RT-EM900*1 RT-EM810*1 RT-EM800*1 RT-EM600*1 RT-EM300*1*2	RT-CL900 RT-CL800 RT-MT900 SM-RT900 SM-RT800 SM-RT99-A SM-RT81 SM-RT70
BR-S700 BR-S7000	Resin	-	-	-	-	-	-
BR-MT410	Resin	Wide	-	SM-RT30 RT-EM300*1	-	-	-
BR-T675 BR-T615 BR-M4050 BR-MT500 BR-M446 BR-MT400 BR-M3050 BR-M395 BR-M375 BR-MT200 BR-M365 BR-M315 BR-TX805 BR-UR300	Resin	Wide	-	-	SM-RT56 SM-RT54 SM-RT30 SM-RT26 SM-RT10 RT-EM300*1	SM-RT56 SM-RT54 SM-RT30 SM-RT26 SM-RT10 RT-EM300*1	-
BR-R9270*7 BR-R9170*3 BR-R8170 BR-R8070 BR-R7170 BR-R7070 BR-4770 BR-RS805 BR-R785 BR-RS785 BR-RS505 BR-RS405 BR-RS305 BR-RX820 BR-RX820-LE BR-RX810 BR-RX400	Metal / Resin	Narrow	-	-	RT-CL900 RT-CL800 RT-MT905 RT-MT900 RT-MT800 SM-RT800 SM-RT86 SM-RT81 SM-RT76 SM-RT70 SM-RT66 SM-RT64 SM-RT56*2 SM-RT54*2 SM-RT30*2 SM-RT26*2 SM-RT10*2 RT-EM910*1 RT-EM900*1 RT-EM810*1 RT-EM800*1 RT-EM600*1 RT-EM300*1*2	RT-CL900 RT-CL800 RT-MT900 SM-RT900 RT-MT800 SM-RT800 SM-RT86 SM-RT81 SM-RT76 SM-RT70 SM-RT66 SM-RT64 SM-RT56*2 SM-RT54*2 SM-RT30*2 SM-RT26*2 SM-RT10*2 RT-EM910*1 RT-EM910*1 RT-EM900*1 RT-EM810*1 RT-EM800*1 RT-EM600*1 RT-EM300*1*2	RT-CL900 RT-CL800 RT-MT900 SM-RT900 RT-MT800 SM-RT800 SM-RT99-A SM-RT81 SM-RT70 SM-RT64
BR-CX77 BR-R517 BR-R317	Metal / Resin	Narrow	-	-	-	SM-RT99 SM-RT86 SM-RT81 SM-RT76 SM-RT70 SM-RT66 SM-RT64	SM-RT99 SM-RT99-A SM-RT81
BR-U5000*3	Metal / Resin	Narrow	-	-	-	SM-RT99 SM-RT86 SM-RT81 SM-RT76 SM-RT70 SM-RT66 SM-RT64	SM-RT500 SM-RT99 SM-RT99-A SM-RT81

- *1 Rotor for speed sensor SM-DUE11, rear only
- *2 Resin pad only
- *3 Not compatible with rear 180 mm (M) rotors
- *4 Not compatible with 220mm (LL) and 203 mm (L) rotors
- *5 For rear only. Not compatible with 220mm (LL), 203 mm (L) and 180 mm (M) rotors.
- *6 For rear only. Not compatible 220mm (LL) and with 203 mm (L) rotors.
- *7 Not compatible with 180 mm (M) rotors.
- *8 Not compatible with 140 mm (SS) rotors.

Wide type rotor

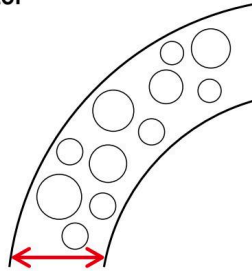

Narrow type rotor

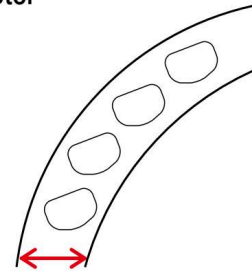

NOTE

- SM-RT56 / SM-RT54 / SM-RT30 / SM-RT26 / SM-RT10 / RT-EM300 are compatible with Resin pad caliper specification only. If use with metal pads, rotor will be easily damaged.
- When using 140 mm rotor, braking power is less than 160 mm, please confirm the power is enough for your purpose. 140 mm rotor is recommended for rear use only.
- Narrow type 2 piece rotors are not compatible to brake caliper for Wide type rotor because of interference.
- BR-UR300 doesn't need front mount bracket and rear adapter.

Compatibility of lock ring with hubs

C-612

Front hub (Disc Brake)

Type	Fixing type of lock ring		
	Internal spline	both Internal & external spline	External spline
QR type	✓	✓	✓
12 mm E-THRU type	✓	✓*	✓
15 mm E-THRU type	-	✓*	✓
20 mm thru axle type	-	✓*	✓

* For E-THRU hub, "Internal & external spline" type lock ring can not be install by TL-LR11. Please Tighten with TL-FC36.

FREEHUB (Disc Brake)

Model No.	Fixing type of lock ring		
	Internal spline	Internal & external spline	External spline
FH-M9111 FH-M9111-B FH-M9111-BS FH-M9000 FH-M9010 FH-M9010-B FH-MT901-B FH-MT901-BS	-	-	✓
Other models (MTB, Trekking, ROAD, URBAN)	✓	✓	✓

Compatibility between brake systems (MT400 series)

C-606

	BR-MT400	BR-MT410	BR-MT420
BL-MT400	✓	✓	-
BL-MT402-3A	✓	✓	✓
BL-MT401-3A	✓	✓	-
BL-MT401	✓	✓	✓
BL-M4100	✓	✓	✓

Combination chart (mechanical disc brake)

C-462

Mechanical disc brake combination chart C-463

In order to realize the best performance, we recommend that the following combination be used.

Model No.	Mount type	Brake lever
BR-M375 BR-TX805	*	V-BRAKE BL (2 finger)
BR-R517	*	Road lever**
BR-R317	*	Road lever**
BR-CX77	*	Road lever**
BR-RS305	FLAT MOUNT	Road lever**

* Front mount: International standard / Post mount, Rear mount: International standard / Post mount

** For BL-R780 / 4600 / 5700

Mechanical disc brake and brake lever compatibility C-464

Model No.	Brake lever type		
	2 finger	3,4 finger	3,4 finger w/ POWER MODULATOR* w/ SM-PM50
BR-M375	✓	-	✓
BR-TX805	✓	-	✓

* POWER MODULATOR must be used for front brake

MTB, Trekking, URBAN, LIFESTYLE C-732

Connection		SM-BH90-JK-SSR	SM-BH90-SBM	SM-BH90-SBLS	SM-BH90-SBS	SM-BH90-SB	SM-BH90-SS
Rigidity		Straight - Straight	Straight - Banjo	Straight - Banjo	Straight - Banjo	Straight - Banjo	Straight - Straight
		High power	High power	High power	High power	High power	High power
BL-M9100	BR-M9100	-	-	-	-	-	✓
BL-M9100	BR-M9110	-	-	-	-	-	✓
BL-M9120	BR-M9120	-	✓	-	-	-	-
BL-M9000	BR-M9000	-	✓	-	-	-	-
BL-M9020	BR-M9020	-	✓	-	-	✓	-
BL-M820	BR-M820	-	-	✓	-	-	-
BL-M8100	BR-M8100	-	✓	-	-	-	-
BL-M8100	BR-M8110	-	-	-	-	-	✓
BL-M8100	BR-M8120	-	✓	-	-	-	-
BL-M8000	BR-M8000	-	✓	-	-	✓	-
BL-M8000	BR-M8020	-	-	✓	-	-	-
BL-T8100	BR-M8100	-	✓	-	-	-	-
BL-T8100	BR-M8120	-	✓	-	-	-	-
BL-M7100	BR-M7100	-	✓	-	-	-	-
BL-M7100	BR-M7110	-	-	-	-	-	✓
BL-M7100	BR-M7120	-	✓	-	-	-	-
BL-M7000	BR-M7000	-	✓	-	-	✓	-
BL-M6100	BR-M6100	-	-	-	-	-	✓
BL-M6100	BR-M6120	-	-	-	-	-	✓
BL-T675	BR-T675	-	-	-	-	-	✓
BL-M640	BR-M640	-	-	✓	✓	-	-
BL-M6000	BR-M6000	-	-	-	-	-	✓
BL-M4100	BR-MT410	-	-	-	-	-	-
BL-M4100	BR-MT420	-	-	-	-	-	✓
BL-T6000	BR-M6000	-	-	-	-	-	-
BL-S7000	BR-S7000	-	-	-	-	-	-

Level of compatibility

✓: Compatible

*: Refer to manual of SM-BH80, SM-BH59 (brake hose 10 m coil) for assembling / disassembling banjo unit

-: Impossible to use

		SM-BH90-JK-SSR	SM-BH90-SBM	SM-BH90-SBLS	SM-BH90-SBS	SM-BH90-SB	SM-BH90-SS
Connection		Straight - Straight	Straight - Banjo	Straight - Banjo	Straight - Banjo	Straight - Banjo	Straight - Straight
Rigidity		High power	High power	High power	High power	High power	High power
BL-MT501	BR-MT520	-	-	-	-	-	✓
BL-MT501	BR-MT500	-	-	-	-	-	-
BL-MT500	BR-MT500	-	-	-	-	-	-
ST-M4050	BR-M4050	-	-	-	-	-	-
ST-M3050	BR-M3050	-	-	-	-	-	-
BL-T445	BR-M446	-	-	-	-	-	-
BL-MT400	BR-MT400	-	-	-	-	-	-
BL-MT401	BR-MT400	-	-	-	-	-	-
BL-MT401	BR-MT410	-	-	-	-	-	-
BL-MT401	BR-MT420	-	-	-	-	-	✓
BL-MT401-3A	BR-MT400	-	-	-	-	-	-
BL-MT402-3A	BR-MT400	-	-	-	-	-	-
BL-MT402-3A	BR-MT410	-	-	-	-	-	-
BL-MT402-3A	BR-MT420	-	-	-	-	-	✓
BL-M425 BL-M396	BR-M395	-	-	-	-	-	-
BL-MT201	BR-MT200	-	-	-	-	-	-
BL-MT200	BR-MT200	-	-	-	-	-	-
BL-MT201	BR-UR300	-	-	-	-	-	-
BL-MT200	BR-UR300	-	-	-	-	-	-
BL-M365	BR-M365	-	-	-	-	-	-
BL-M315	BR-M315	-	-	-	-	-	-
ST-EF515	BR-MT200	-	-	-	-	-	-
ST-EF505	BR-M315	-	-	-	-	-	-
ST-EF505	BR-MT200	-	-	-	-	-	-
BL-S700	BR-S700	-	✓	-	-	✓	-
BL-U8000	BR-U8000	-	✓	-	-	-	-
BL-U8000	BR-U8020	-	✓	-	-	-	-
BL-U5000	BR-U5000	-	-	-	-	-	-
BL-U5010		-	-	-	-	-	-
ST-U5060		-	-	-	-	-	-
BL-UR405	BR-MT410	-	-	-	-	-	-

Level of compatibility

✓: Compatible

*: Refer to manual of SM-BH80, SM-BH59 (brake hose 10 m coil) for assembling / disassembling banjo unit

-: Impossible to use

		SM-BH59-J-SS	SM-BH59-JK-SS (MTB)	SM-BH59-JK-SS (ROAD)	SM-BH59-JK-SSR	SM-BH59-SB	SM-BH59-SB-J
Connection		Straight - Straight	Straight - Straight	Straight - Straight	Straight - Straight	Straight - Banjo	Straight - Banjo
Rigidity		Standard	Standard	Standard	Standard	Standard	Standard
BL-M9100	BR-M9100	-	-	-	-	-	-
BL-M9100	BR-M9110	-	-	-	-	-	-
BL-M9120	BR-M9120	-	-	-	-	-	-
BL-M9000	BR-M9000	-	-	-	-	-	-
BL-M9020	BR-M9020	-	-	-	-	-	-
BL-M820	BR-M820	-	-	-	-	-	-
BL-M8100	BR-M8100	-	-	-	-	-	-
BL-M8100	BR-M8110	-	-	-	-	-	-
BL-M8100	BR-M8120	-	-	-	-	-	-
BL-M8000	BR-M8000	-	-	-	-	-	-
BL-M8000	BR-M8020	-	-	-	-	-	-
BL-T8100	BR-M8100	-	-	-	-	-	-
BL-T8100	BR-M8120	-	-	-	-	-	-
BL-M7100	BR-M7100	-	-	-	-	-	-
BL-M7100	BR-M7110	-	-	-	-	-	-
BL-M7100	BR-M7120	-	-	-	-	-	-
BL-M7000	BR-M7000	-	-	-	-	-	-
BL-M6100	BR-M6100	-	-	-	-	-	-
BL-M6100	BR-M6120	-	-	-	-	-	-
BL-T675	BR-T675	-	-	-	-	-	-
BL-M640	BR-M640	-	-	-	-	-	-
BL-M6000	BR-M6000	-	-	-	-	-	-
BL-M4100	BR-MT410	-	✓	-	-	-	-
BL-M4100	BR-MT420	-	-	-	-	-	-
BL-T6000	BR-M6000	-	✓	-	-	-	-
BL-S7000	BR-S7000	-	✓	-	-	-	-

Level of compatibility

✓: Compatible

*: Refer to manual of SM-BH80, SM-BH59 (brake hose 10 m coil) for assembling / disassembling banjo unit

-: Impossible to use

		SM-BH59-J-SS	SM-BH59-JK-SS (MTB)	SM-BH59-JK-SS (ROAD)	SM-BH59-JK-SSR	SM-BH59-SB	SM-BH59-SB-J
Connection		Straight - Straight	Straight - Straight	Straight - Straight	Straight - Straight	Straight - Banjo	Straight - Banjo
Rigidity		Standard	Standard	Standard	Standard	Standard	Standard
BL-MT501	BR-MT520	-	-	-	-	-	-
BL-MT501	BR-MT500	-	✓	-	-	-	-
BL-MT500	BR-MT500	-	✓	-	-	-	-
ST-M4050	BR-M4050	-	✓	-	-	-	-
ST-M3050	BR-M3050	-	✓	-	-	-	-
BL-T445	BR-M446	-	✓	-	-	-	-
BL-MT400	BR-MT400	-	✓	-	-	-	-
BL-MT401	BR-MT400	-	✓	-	-	-	-
BL-MT401	BR-MT410	-	✓	-	-	-	-
BL-MT401	BR-MT420	-	-	-	-	-	-
BL-MT401-3A	BR-MT400	-	✓	-	-	-	-
BL-MT402-3A	BR-MT400	-	✓	-	-	-	-
BL-MT402-3A	BR-MT410	-	✓	-	-	-	-
BL-MT402-3A	BR-MT420	-	-	-	-	-	-
BL-M425 BL-M396	BR-M395	-	✓	-	-	-	-
BL-MT201	BR-MT200	-	✓	-	-	-	-
BL-MT200	BR-MT200	-	✓	-	-	-	-
BL-MT201	BR-UR300	-	✓	-	-	-	-
BL-MT200	BR-UR300	-	✓	-	-	-	-
BL-M365	BR-M365	-	✓	-	-	-	-
BL-M315	BR-M315	-	✓	-	-	-	-
ST-EF515	BR-MT200	-	✓	-	-	-	-
ST-EF505	BR-M315	-	✓	-	-	-	-
ST-EF505	BR-MT200	-	✓	-	-	-	-
BL-S700	BR-S700	-	-	-	-	-	-
BL-U8000	BR-U8000	-	-	-	-	-	-
BL-U8000	BR-U8020	-	-	-	-	-	-
BL-U5000		-	-	✓	-	-	-
BL-U5010	BR-U5000	-	-	✓	-	-	-
ST-U5060		-	-	✓	-	-	-
BL-UR405	BR-MT410	-	✓	-	-	-	-

Level of compatibility

✓: Compatible

*: Refer to manual of SM-BH80, SM-BH59 (brake hose 10 m coil) for assembling / disassembling banjo unit

-: Impossible to use

ROAD, Gravel, LIFESTYLE C-733

Connection		SM-BH90-JK-SSR	SM-BH90-SBM	SM-BH90-SBLS	SM-BH90-SBS	SM-BH90-SB	SM-BH90-SS
Rigidity		Straight - Straight	Straight - Banjo	Straight - Banjo	Straight - Banjo	Straight - Banjo	Straight - Straight
		High power	High power	High power	High power	High power	High power
ST-R9270	BR-R9270	✓	-	-	-	-	-
ST-R9120	BR-R9170	✓	-	-	-	-	-
ST-R9170	BR-R9170	✓	-	-	-	-	-
ST-R9180	BR-R9170	✓	-	-	-	-	-
ST-R8170	BR-R8170	✓	-	-	-	-	-
ST-R8020	BR-R8070	✓	-	-	-	-	-
ST-R8070	BR-R8070	✓	-	-	-	-	-
ST-R7120	BR-R7170	✓	-	-	-	-	-
ST-R7170	BR-R7170	✓	-	-	-	-	-
ST-R7020	BR-R7070	✓	-	-	-	-	-
ST-R7025	BR-R7070	✓	-	-	-	-	-
ST-R785	BR-RS805	-	-	-	-	-	-
ST-R785	BR-RS785	-	-	-	-	-	-
ST-R785	BR-R785	-	-	-	-	-	-
ST-RS685	BR-RS805	-	-	-	-	-	-
ST-RS685	BR-RS785	-	-	-	-	-	-
ST-RS685	BR-R785	-	-	-	-	-	-
ST-RS505	BR-RS785	-	-	-	-	-	-
ST-RS505	BR-RS505	-	-	-	-	-	-
ST-RS405	BR-RS405	-	-	-	-	-	-
BL-RS600	BR-RS405	-	-	-	-	-	-
ST-RX820	BR-RX820	✓	-	-	-	-	-
ST-RX825	BR-RX820	✓	-	-	-	-	-
ST-RX815	BR-RX810	✓	-	-	-	-	-
ST-RX810-LE	BR-RX820-LE	✓	-	-	-	-	-
BL-T8100-LE	BR-RX820-LE	-	-	-	-	-	✓
ST-RX810	BR-RX810	✓	-	-	-	-	-
BL-RX820	BR-RX820	✓	-	-	-	-	-
BL-RX810	BR-RX810	✓	-	-	-	-	-
ST-RX610	BR-RX400	✓	-	-	-	-	-
ST-RX600	BR-RX400	✓	-	-	-	-	-
BL-RX610	BR-RX400	✓	-	-	-	-	-
BL-RX600	BR-RX400	✓	-	-	-	-	-
ST-RX400	BR-RX400	✓	-	-	-	-	-

Level of compatibility

✓: Compatible

*: Refer to manual of SM-BH80, SM-BH59 (brake hose 10 m coil) for assembling / disassembling banjo unit

-: Impossible to use

		SM-BH59-J-SS	SM-BH59-JK-SS (MTB)	SM-BH59-JK-SS (ROAD)	SM-BH59-JK-SSR	SM-BH59-SB	SM-BH59-SB-J
Connection		Straight - Straight	Straight - Straight	Straight - Straight	Straight - Straight	Straight - Banjo	Straight - Banjo
Rigidity		Standard	Standard	Standard	Standard	Standard	Standard
ST-R9270	BR-R9270	-	-	-	-	-	-
ST-R9120 ST-R9170	BR-R9170	-	-	-	-	-	-
ST-R9180	BR-R9170	-	-	-	-	-	-
ST-R8170	BR-R8170	-	-	-	-	-	-
ST-R8020 ST-R8070	BR-R8070	-	-	-	-	-	-
ST-R7120	BR-R7170	-	-	-	-	-	-
ST-R7170	BR-R7170	-	-	-	-	-	-
ST-R7020	BR-R7070	-	-	-	-	-	-
ST-R7025	BR-R7070	-	-	-	-	-	-
ST-R785	BR-RS805	✓	-	-	-	-	-
ST-R785	BR-RS785	✓	-	-	-	-	-
ST-R785	BR-R785	-	-	-	-	✓	✓
ST-RS685	BR-RS805	✓	-	✓	-	-	-
ST-RS685	BR-RS785	✓	-	✓	-	-	-
ST-RS685	BR-R785	-	-	-	-	✓	✓
ST-RS505	BR-RS785	✓	-	✓	-	-	-
ST-RS505	BR-RS505	✓	-	✓	-	-	-
ST-RS405	BR-RS405	-	-	✓	-	-	-
BL-RS600	BR-RS405	-	✓	-	-	-	-
ST-RX820	BR-RX820	-	-	-	-	-	-
ST-RX825	BR-RX820	-	-	-	-	-	-
ST-RX815	BR-RX810	-	-	-	-	-	-
ST-RX810-LE	BR-RX820-LE	-	-	-	-	-	-
BL-T8100-LE	BR-RX820-LE	-	-	-	-	-	-
ST-RX810	BR-RX810	-	-	-	-	-	-
BL-RX820	BR-RX820	-	-	-	-	-	-
BL-RX810	BR-RX810	-	-	-	-	-	-
ST-RX610	BR-RX400	-	-	-	-	-	-
ST-RX600	BR-RX400	-	-	-	-	-	-
BL-RX610	BR-RX400	-	-	-	-	-	-
BL-RX600	BR-RX400	-	-	-	-	-	-
ST-RX400	BR-RX400	-	-	-	-	-	-

Level of compatibility

✓: Compatible



*: Refer to manual of SM-BH80, SM-BH59 (brake hose 10 m coil) for assembling / disassembling banjo unit

-: Impossible to use

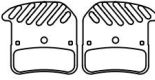

Banjo screw	Special	Normal	Short	BR-M9120 SPEC.	BR-M8100 SPEC.
BR-M9120	-	-	-	✓	-
BR-M9000	✓	-	-	-	-
BR-M9020	✓	✓	-	-	-
BR-M820	-	-	✓	-	✓
BR-M8100	-	-	-	-	✓
BR-M8120	-	-	-	✓	-
BR-M8000	✓	✓	-	-	-
BR-M8020	-	-	✓	-	-
BR-M7100	-	-	-	-	✓
BR-M7120	-	-	-	✓	-
BR-M7000	✓	✓	-	-	-
BR-M640	-	-	✓	-	✓
BR-S700	✓	✓	-	-	-
BR-R785	✓	✓	-	-	-
BR-U8000	-	-	-	-	✓
BR-U8020	-	-	-	✓	-

Brake pad line-up

Brake pad for hydraulic disc brake (4-piston) C-652

Pad Shape Type							
		D-type		H-type		N-type	
Type		Narrow type		Narrow type		Narrow type	
		D03S-RX	D02S-MX	H03A-RF	H03C-MF	N03A-RF	N04C-MF
		Resin	Metal	Resin	Metal	Resin	Metal
Characteristics	Modulation	★★★★★	★★★★☆	★★★★★	★★★★☆	★★★★★	★★★★☆
	Power	★★★★☆	★★★★★	★★★★☆	★★★★★	★★★★☆	★★★★★
	Durability	★★★★★	★★★★★	★★★★★	★★★★★	★★★★★	★★★★★
	Anti-fading	★★★★☆	★★★★★	★★★★☆	★★★★★	★★★★☆	★★★★★
	Silence	★★★★★	★★★★☆	★★★★★	★★★★☆	★★★★★	★★★★☆
Pad Radiator fin		-	-	✓	✓	✓	✓
High heat insulation		-	-	-	-	-	-
Pad Back plate	Titanium	-	-	-	-	-	-
	Aluminum	-	-	✓	-	✓	-
	Stainless steel/ Aluminum	-	-	-	✓	-	✓
	Stainless steel	✓	✓	-	-	-	-
BR-M9120	Hydraulic	Option	Option	-	-	Standard	Standard
BR-M8120	Hydraulic	Option	Option	-	-	Standard	Standard
BR-M7120	Hydraulic	Standard	Option	-	-	Standard	Option
BR-M6120	Hydraulic	Standard	Option	-	-	-	-
BR-MT520	Hydraulic	Standard	Standard	-	-	-	-
BR-MT420	Hydraulic	Standard	Standard	-	-	-	-
BR-M8020	Hydraulic	Option	-	Standard	Option	-	-
BR-M820	Hydraulic	-	-	Standard	Standard	-	-
BR-U8020	Hydraulic	Standard	Option	-	-	Standard	Option

Brake pad for hydraulic disc brake (2-piston) and mechanical disc brake C-653

Pad Shape Type									
		B-type Wide type		G-type Narrow type					
Type		B03S-RX	B05S-RX	G03A-RX	G05A-RX	G03S-RX	G05S-RX	G04S-MX	G04Ti-MX
		Resin	Resin	Resin	Resin	Resin	Resin	Metal	Metal
Characteristics	Modulation	★★★★★	★★★★★	★★★★★	★★★★★	★★★★★	★★★★★	★★★★☆	★★★★☆
	Power	★★★★☆	★★★★☆	★★★★☆	★★★★☆	★★★★☆	★★★★☆	★★★★★	★★★★★
	Durability	★★★★★	★★★★★ ^{*1}	★★★★★	★★★★★ ^{*1}	★★★★★	★★★★★ ^{*1}	★★★★★	★★★★★
	Anti-fading	★★★★☆	★★★★☆	★★★★☆	★★★★☆	★★★★☆	★★★★☆	★★★★★	★★★★★
	Silence	★★★★★	★★★★★	★★★★★	★★★★★	★★★★★	★★★★★	★★★★☆	★★★★☆
Pad Radiator fin		-	-	-	-	-	-	-	-
High heat insulation		-	-	✓	✓	✓	✓	-	-
Pad Back plate	Titanium	-	-	-	-	-	-	-	✓
	Aluminum	-	-	✓	✓	-	-	-	-
	Stainless steel/ Aluminum	-	-	-	-	-	-	-	-
	Stainless steel	✓	✓	-	-	✓	✓	✓	-
BR-M9100	Hydraulic	-	-	-	-	-	-	-	-
BR-M9110	Hydraulic	-	-	-	-	-	-	-	-
BR-M8100	Hydraulic	-	-	Standard	Standard	-	-	Standard	-
BR-M8110	Hydraulic	-	-	-	-	-	-	-	-
BR-M7100	Hydraulic	-	-	-	-	Standard	Standard	Standard	-
BR-M7110	Hydraulic	-	-	-	-	-	-	-	-
BR-M8000	Hydraulic	-	-	Standard	Standard	-	-	Option	-
BR-M6100	Hydraulic	-	-	-	-	Standard	Standard	Option	-
BR-M6000	Hydraulic	-	-	Standard	Standard	-	-	Option	-
BR-MT500	Hydraulic	Standard	Standard	-	-	-	-	-	-
BR-MT400	Hydraulic	Standard	Standard	-	-	-	-	-	-
BR-MT410	Hydraulic	Standard	Standard	-	-	-	-	-	-
BR-MT200	Hydraulic	Standard	Standard	-	-	-	-	-	-
BR-M375	Mechanical	Standard	Standard	-	-	-	-	-	-
BR-TX805	Mechanical	Standard	Standard	-	-	-	-	-	-
BR-R9270	Hydraulic	-	-	-	-	-	-	-	-
BR-R9170	Hydraulic	-	-	-	-	-	-	-	-
BR-R8170	Hydraulic	-	-	-	-	-	-	-	-
BR-R8070	Hydraulic	-	-	-	-	-	-	-	-
BR-R7170	Hydraulic	-	-	-	-	-	-	-	-
BR-R7070	Hydraulic	-	-	-	-	-	-	-	-
BR-4770	Hydraulic	-	-	-	-	-	-	-	-
BR-RS785	Hydraulic	-	-	Option	Option	-	-	-	-
BR-RS405	Hydraulic	-	-	-	-	-	-	-	-
BR-RX820	Hydraulic	-	-	-	-	-	-	-	-
BR-RX820-LE	Hydraulic	-	-	-	-	-	-	-	-
BR-RX810	Hydraulic	-	-	-	-	-	-	-	-
BR-RX400	Hydraulic	-	-	-	-	-	-	-	-
BR-UR300	Hydraulic	Standard	Standard	-	-	-	-	-	-
BR-S7000	Hydraulic	-	-	-	-	Standard	Standard	-	-
BR-RS305	Mechanical	-	-	-	-	-	-	-	-
BR-R317	Mechanical	-	-	Standard	Standard	-	-	-	-
BR-U8000	Hydraulic	-	-	Standard	Standard	-	-	Option	-

*1 "05" pad is more durable than "03" pad in the same type by 40%

Pad Shape Type							
		K-type Narrow type					
Type		K03S-RX	K05S-RX	K03Ti-RX	K05Ti-RX	K04S-MX	K04Ti-MX
		Resin	Resin	Resin	Resin	Metal	Metal
Characteristics	Modulation	★★★★★	★★★★★	★★★★★	★★★★★	★★★★☆	★★★★☆
	Power	★★★★☆	★★★★☆	★★★★☆	★★★★☆	★★★★★	★★★★★
	Durability	★★★★★	★★★★★*1	★★★★★	★★★★★*1	★★★★★	★★★★★
	Anti-fading	★★★★☆	★★★★☆	★★★★☆	★★★★☆	★★★★★	★★★★★
	Silence	★★★★★	★★★★★	★★★★★	★★★★★	★★★★☆	★★★★☆
Pad Radiator fin		-	-	-	-	-	-
High heat insulation		✓	✓	✓	✓	-	-
Pad Back plate	Titanium	-	-	✓	✓	-	✓
	Aluminum	-	-	-	-	-	-
	Stainless steel/ Aluminum	-	-	-	-	-	-
	Stainless steel	✓	✓	-	-	✓	-
BR-M9100	Hydraulic	-	-	Standard	Standard	-	Standard
BR-M9110	Hydraulic	-	-	Standard	Standard	-	Standard
BR-M8100	Hydraulic	-	-	-	-	-	-
BR-M8110	Hydraulic	Standard	Standard	-	-	Standard	-
BR-M7100	Hydraulic	-	-	-	-	-	-
BR-M7110	Hydraulic	Standard	Standard	-	-	Standard	-
BR-M8000	Hydraulic	-	-	-	-	-	-
BR-M6100	Hydraulic	-	-	-	-	-	-
BR-M6000	Hydraulic	-	-	-	-	-	-
BR-MT500	Hydraulic	-	-	-	-	-	-
BR-MT400	Hydraulic	-	-	-	-	-	-
BR-MT410	Hydraulic	-	-	-	-	-	-
BR-MT200	Hydraulic	-	-	-	-	-	-
BR-M375	Mechanical	-	-	-	-	-	-
BR-TX805	Mechanical	-	-	-	-	-	-
BR-R9270	Hydraulic	-	-	Standard	Standard	-	Option
BR-R9170	Hydraulic	-	-	Standard	Standard	-	Option
BR-R8170	Hydraulic	Standard	Standard	-	-	-	-
BR-R8070	Hydraulic	Standard	Standard	-	-	Option	-
BR-R7170	Hydraulic	Standard	Standard	-	-	-	-
BR-R7070	Hydraulic	Standard	Standard	-	-	Option	-
BR-4770	Hydraulic	Standard	Standard	-	-	Standard	-
BR-RS785	Hydraulic	-	-	-	-	-	-
BR-RS405	Hydraulic	Standard	Standard	-	-	-	-
BR-RX820	Hydraulic	Standard	Standard	-	-	-	-
BR-RX820-LE	Hydraulic	Standard	Standard	-	-	-	-
BR-RX810	Hydraulic	Standard	Standard	-	-	Option	-
BR-RX400	Hydraulic	Standard	Standard	-	-	Option	-
BR-UR300	Hydraulic	-	-	-	-	-	-
BR-S7000	Hydraulic	-	-	-	-	-	-
BR-RS305	Mechanical	Standard	Standard	-	-	-	-
BR-R317	Mechanical	-	-	-	-	-	-
BR-U8000	Hydraulic	-	-	-	-	-	-

*1 "05" pad is more durable than "03" pad in the same type by 40%

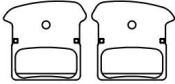
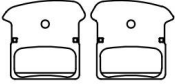
Pad Shape Type							
		J-type			L-type		
Type		Narrow type			Narrow type		
		J03A-RF Resin	J05A-RF Resin	J04C-MF Metal	L03A-RF Resin	L05A-RF Resin	L04C-MF Metal
Characteristics	Modulation	★★★★★	★★★★★	★★★★☆	★★★★★	★★★★★	★★★★☆
	Power	★★★★☆	★★★★☆	★★★★★	★★★★☆	★★★★☆	★★★★★
	Durability	★★★★★	★★★★★*1	★★★★★	★★★★★	★★★★★*1	★★★★★
	Anti-fading	★★★★☆	★★★★☆	★★★★★	★★★★☆	★★★★☆	★★★★★
	Silence	★★★★★	★★★★★	★★★★☆	★★★★★	★★★★★	★★★★☆
Pad Radiator fin		✓	✓	✓	✓	✓	✓
High heat insulation		✓	✓	-	✓	✓	-
Pad Back plate	Titanium	-	-	-	-	-	-
	Aluminum	✓	✓	-	✓	✓	-
	Stainless steel/ Aluminum	-	-	✓	-	-	✓
	Stainless steel	-	-	-	-	-	-
BR-M9100	Hydraulic	-	-	-	-	-	-
BR-M9110	Hydraulic	-	-	-	-	-	-
BR-M8100	Hydraulic	Option	Option	Option	-	-	-
BR-M8110	Hydraulic	-	-	-	Option	Option	Option
BR-M7100	Hydraulic	Option	Option	Option	-	-	-
BR-M7110	Hydraulic	-	-	-	Option	Option	Option
BR-M8000	Hydraulic	Standard	Standard	Option	-	-	-
BR-M6100	Hydraulic	Standard	Standard	-	-	-	-
BR-M6000	Hydraulic	Standard	Standard	-	-	-	-
BR-MT500	Hydraulic	-	-	-	-	-	-
BR-MT400	Hydraulic	-	-	-	-	-	-
BR-MT410	Hydraulic	-	-	-	-	-	-
BR-MT200	Hydraulic	-	-	-	-	-	-
BR-M375	Mechanical	-	-	-	-	-	-
BR-TX805	Mechanical	-	-	-	-	-	-
BR-R9270	Hydraulic	-	-	-	Standard	Standard	Option
BR-R9170	Hydraulic	-	-	-	Standard	Standard	Option
BR-R8170	Hydraulic	-	-	-	Standard	Standard	Option
BR-R8070	Hydraulic	-	-	-	Standard	Standard	Option
BR-R7170	Hydraulic	-	-	-	Standard	Standard	Option
BR-R7070	Hydraulic	-	-	-	Standard	Standard	Option
BR-4770	Hydraulic	-	-	-	Option	Option	-
BR-RS785	Hydraulic	Standard	Standard	Standard	-	-	-
BR-RS405	Hydraulic	-	-	-	Option	Option	-
BR-RX820	Hydraulic	-	-	-	Standard	Standard	Option
BR-RX820-LE	Hydraulic	-	-	-	Standard	Standard	Option
BR-RX810	Hydraulic	-	-	-	Standard	Standard	Option
BR-RX400	Hydraulic	-	-	-	Standard	Standard	Option
BR-UR300	Hydraulic	-	-	-	-	-	-
BR-S7000	Hydraulic	-	-	-	-	-	-
BR-RS305	Mechanical	-	-	-	Option	Option	-
BR-R317	Mechanical	-	-	-	-	-	-
BR-U8000	Hydraulic	Option	Option	-	-	-	-

*1 "05" pad is more durable than "03" pad in the same type by 40%

How to read Model No. C-194

(1)
(2)
(3)
(4)
(5)
(6)
S - **M** **A** - **F** **203** **S** / **P**

(1)	Small parts
(2)	Mount adapter
(3)	F = Front and Rear * R = Rear
(4)	Rotor size **
(5)	Caliper mount type S = International A-standard P = Post D = Flat mount
(6)	Suspension / Frame type S = International A-standard P = Post D = Flat mount

NOTE

* This part may be used in the rear.

In this case, the rotor size description is also different. Refer to the [C-195](#)

** Rotor size descriptions are for the 160 mm direct post mount and International A standard forks and frames. Refer to [C-195](#) for other mount types.

Application table for adapter C-195

For post mount brake caliper

Fork and frame mount type			Rotor size				
			140 mm (SS)	160 mm (S)	180 mm (M)	203 mm (L)	220 mm (LL)
Post mount	Front	140 mm direct	Direct mount	SM-MA90-F180P/P SM-MA-F180P/P2 (for R785)	-	-	-
		160 mm direct	-	Direct mount	SM-MA90-F180P/P SM-MA-F180P/P2	SM-MA-F203P/P	-
		180 mm direct	-	-	Direct mount	SM-MA90-F203P/PM SM-MA-F203P/PM	SM-MA-F220P/PM
		200 mm direct	-	-	-	SM-MA-F203P/PL2	SM-MA-F220P/PL2
		203 mm direct	-	-	-	Direct mount	SM-MA-F220P/PL
	Rear	140 mm direct	Direct mount	SM-MA90-F180P/P SM-MA-F180P/P2	-	-	-
		160 mm direct	-	Direct mount	SM-MA90-F180P/P SM-MA-F180P/P2	SM-MA-F203P/P	-
		180 mm direct	-	-	Direct mount	SM-MA90-F203P/PM SM-MA-F203P/PM	SM-MA-F220P/PM
		200 mm direct	-	-	-	SM-MA-F203P/PL2	SM-MA-F220P/PL2
		203 mm direct	-	-	-	Direct mount	SM-MA-F220P/PL
International A-standard	Front	-	SM-MA90-F160P/S SM-MA-F160P/S	SM-MA-F180P/S	SM-MA-F203P/S	-	
	Rear	SM-MA90-R140P/S	SM-MA90-R160P/S SM-MA-R160P/S	SM-MA90-R180P/S SM-MA-R180P/S	SM-MA-R203P/S	-	
Flat mount ø140/160	Front	SM-MA-F140P/D	SM-MA-F160P/D	-	-	-	
	Rear	SM-MA-R140P/D	SM-MA-R160P/D	-	-	-	
Flat mount ø160/180	Front	-	-	-	-	-	
	Rear	-	-	-	-	-	





For flat mount brake caliper



Fork and frame mount type			Rotor size		
			140 mm (SS)	160 mm (S)	180 mm (M)
Flat mount	ø140/160	Front	With Y8N230000* on product	With Y8N230000* on product	-
		Rear	Direct mount	SM-MA-R160D/D	-
	ø160/180	Front	-	With Y8N230000* on product	With Y8N230000* on product
		Rear	-	Direct mount	SM-MA-R160D/D
Flat mount BR-UR300	ø140/160	Front	-	Direct mount	-
		Rear	-	Direct mount	-
	ø160/180	Front	-	-	Direct mount
		Rear	-	-	Direct mount

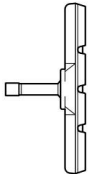

* SHIMANO easy flip-flop bracket system which allow 1 bracket to be compatible with 2 rotor size.

Brake / Shoe line-up

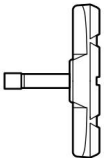
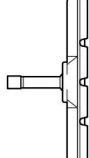
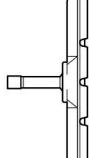
C-201

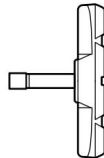
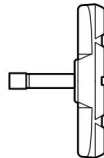
Model No.	M70R2	M70R2 (Severe Condition Shoes)	M70T3	M70T4	M70CT4 (Severe Condition Shoes)	
Brake shoe shape						
Cartridge type	✓	✓	-	-	✓	
Recommended rim	Aluminum	Aluminum	Alumite only	Aluminum	Aluminum	
Characteristics	DRY Power	★★★★★	★★★★★	★★★★☆	★★★★☆	
	WET Power	★★★★☆	★★★★☆	★★★★★	★★★★☆	
	Silence	★★★★☆	★★★★☆	★★★★★	★★★★☆	
	Anti-fading	★★★★☆	★★★★☆	★★★☆☆	★★★★☆	
	Durability (on road)	★★★★★	★★★★★	★★★★☆	★★★★☆	
	Durability (muddy condition)	★★★★☆	★★★★☆	★★★☆☆	★★★★☆	
	Anti-rim attack	★★★★☆	★★★★☆	★★★☆☆	★★★★☆	
	BR-T610	-	-	-	Option	Standard
	BR-T4000	-	-	-	-	-
	BR-MX70	-	-	Option	Option	-
BR-R353	-	-	-	Option	-	

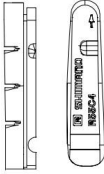
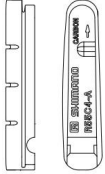
Model No.	M65T3	M65T4	S70C	S70C (Severe Condition Shoes)	S70T	S65T	
Brake shoe shape							
Cartridge type	-	-	✓	✓	-	-	
Recommended rim	Alumite only	Aluminum	Aluminum	Aluminum	Aluminum	Aluminum	
Characteristics	DRY Power	★★★★☆	★★★★★	★★★★★	★★★★☆	★★★★★	
	WET Power	★★★★★	★★★★☆	★★★☆☆	★★★☆☆	★★★★☆	
	Silence	★★★★★	★★★★☆	★★★★☆	★★★★☆	★★★★☆	
	Anti-fading	★★★☆☆	★★★★☆	★★★★★	★★★★★	★★★★★	
	Durability (on road)	★★★★☆	★★★★☆	★★★★★	★★★★☆	★★★★☆	
	Durability (muddy condition)	★★★★☆	★★★★☆	★★★★☆	★★★★☆	★★★★☆	
	Anti-rim attack	★★★☆☆	★★★★☆	★★★★★	★★★★★	★★★★★	
	BR-T610	-	-	Standard	-	Option	-
	BR-T4000	Option	Option	-	-	-	Standard
	BR-MX70	-	-	Standard	-	-	-
BR-R353	-	-	-	-	Standard	-	

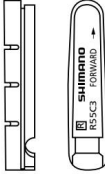
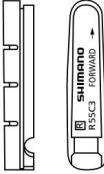
Model No.	R55C4	R55C4 FOR CARBON RIM	R55C4-A FOR CARBON RIM	R55C2	R55C3
Brake shoe shape					
Cartridge type	✓	✓	✓	✓	✓
Recommended rim	Aluminum	Carbon	Carbon	Aluminum	Aluminum
Characteristics	DRY Power	★★★★★	★★★★☆	★★★★★	★★★★★
	WET Power	★★★☆☆	★★★★☆	★★★★☆	★★★★☆
	Silence	★★★★☆	★★★★☆	★★★★☆	★★★★☆
	Anti-fading	★★★★★	★★★★★	★★★★★	★★★★★
	Durability (on road)	★★★★★	★★★★★	★★★★☆	★★★★★
	Durability (muddy condition)	★★★★★	★★★★★	★★★★☆	★★★★★
	Anti-rim attack	★★★★☆	★★★★☆	★★★★☆	★★★★★
	BR-R9200	Standard	Option	Option	-
	BR-R9210	Standard	Option	Option	-
	BR-R9100	Standard	Option	Option	-
	BR-R9110	Standard	Option	Option	-
	BR-R8100	Standard	Option	Option	-
	BR-R8110	Standard	Option	Option	-
	BR-RS811-R	Standard	Option	Option	-
	BR-R8000	Standard	Option	Option	-
	BR-R8010	Standard	Option	Option	-
	BR-R7000	Standard	Option	Option	-
	BR-R7010	Standard	Option	Option	-
	BR-4700	-	-	-	-
	BR-R3000	-	-	-	-
BR-R2000	-	-	-	-	
BR-CX50	-	-	-	-	
BR-R561	-	-	-	-	Standard
BR-R451	-	-	-	-	-

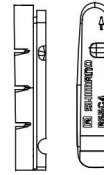
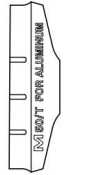
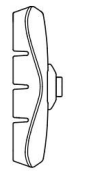
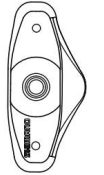
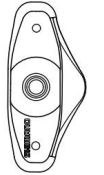
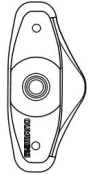
Model No.	R55C+1	R55CT4	M50T	R50T	R50T2	R50T4	R50T5	
Brake shoe shape								
Cartridge type	✓	✓	-	-	-	-	-	
Recommended rim	Aluminum	Aluminum	Aluminum	Aluminum	Aluminum	Aluminum	Aluminum	
Characteristics	DRY Power	★★★★☆	★★★★☆	★★★★☆	★★★★☆	★★★★☆	★★★★★	
	WET Power	★★★☆☆	★★★★☆	★★★★☆	★★★★☆	★★★★☆	★★★★☆	
	Silence	★★★★☆	★★★★☆	★★★★☆	★★★★☆	★★★★☆	★★★★☆	
	Anti-fading	★★★★★	★★★★☆	★★★★☆	★★★★★	★★★★★	★★★★★	
	Durability (on road)	★★★★☆	★★★★☆	★★★★☆	★★★★☆	★★★★☆	★★★★☆	
	Durability (muddy condition)	★★★★☆	★★★★☆	★★★★☆	★★★★☆	★★★★☆	★★★★☆	
	Anti-rim attack	★★★★★	★★★★☆	★★★★☆	★★★★★	★★★★★	★★★★☆	
	BR-R9200	-	Option	-	-	-	-	
	BR-R9210	-	Option	-	-	-	-	
	BR-R9100	-	Option	-	-	-	-	
	BR-R9110	-	Option	-	-	-	-	
	BR-R8100	-	Option	-	-	-	-	
	BR-R8110	-	Option	-	-	-	-	
	BR-RS811-R	-	Option	-	-	-	-	
	BR-R8000	-	Option	-	-	-	-	
	BR-R8010	-	Option	-	-	-	-	
	BR-R7000	-	Option	-	-	-	-	
	BR-R7010	-	Option	-	-	-	-	
	BR-4700	-	-	-	-	-	Option	Standard
	BR-R3000	-	-	-	-	-	Option	Standard
BR-R2000	-	-	-	-	Standard	Option	Standard	
BR-CX50	-	-	-	-	Standard	-	-	
BR-R561	-	Option	-	-	-	-	-	
BR-R451	-	-	-	-	Standard	-	-	

Brake shoe recommendation to rim width

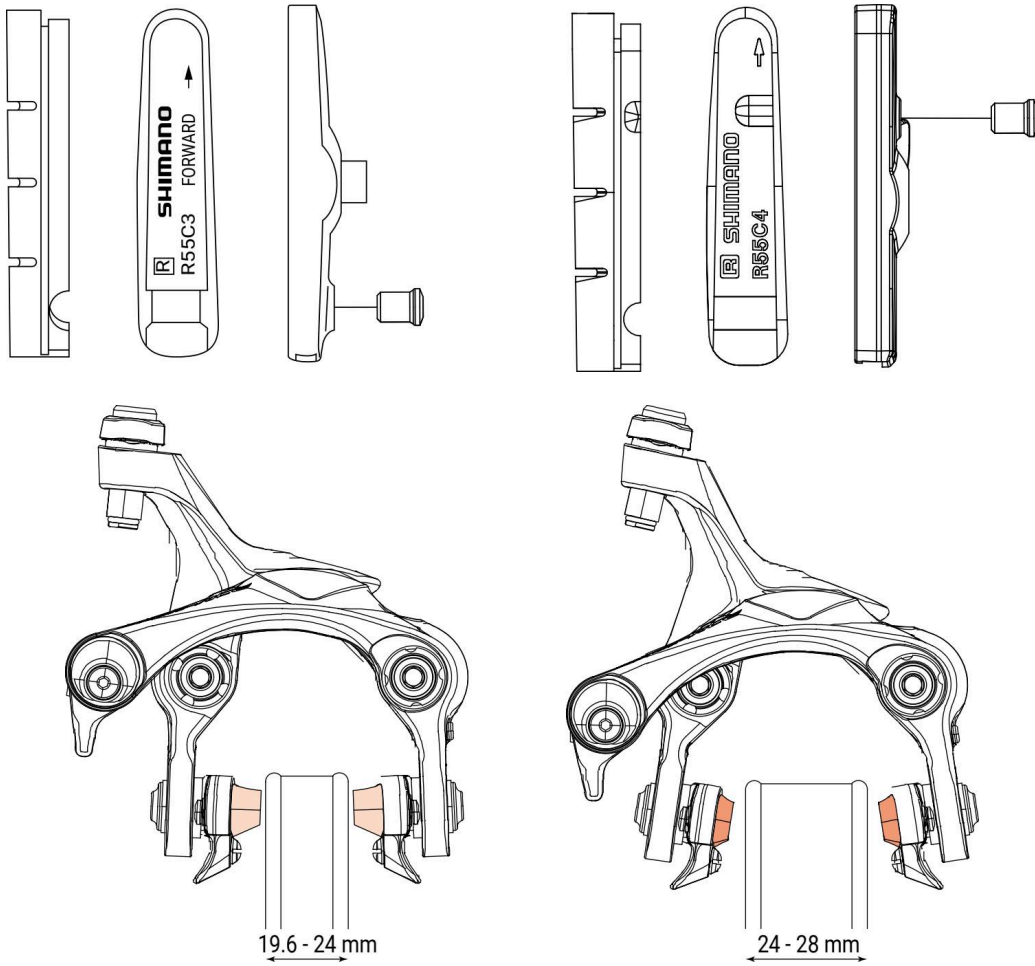

Model No.	Rim width
R55C4 / R55C4 for Carbon rim	19.6 - 24 mm
R55C3 / R55C3 for Carbon rim	
R55C4-A for Carbon rim	24 - 28 mm

Polymer-coated brake cable (BC-9000 / BC-R680) compatible chart

C-306





Series	Brake with polymer-coated brake cable	
DURA-ACE	BR-R9200	✓
	BR-R9210	
	BR-R9100	
	BR-R9110	
ULTEGRA	BR-R8100	✓
	BR-R8110	
	BR-RS811-R	
	BR-R8000	
	BR-R8010	
SHIMANO 105	BR-R7000	✓
	BR-R7010	
	BR-5810	-
	BR-5700	
TIAGRA	BR-4700	✓
SORA	BR-R3000	✓
CLARIS	BR-R2000	✓
Others		-

Compatibility between brake systems

C-466

Depending on the brake and brake lever combination to be used, the relationship between the input at the brake lever and the actual braking force output at the wheels is very easily affected.

Be very careful when combining a brake and brake lever. Incorrect combinations can cause accidents or insufficient braking forces due to improper cable strokes. Be sure to carefully consult the chart below and select the brake and the matching brake lever.

		V-BRAKE		Roller Brake
		BR-T780 BR-MX70 BR-R573 BR-R463 BR-R353 BR-T670 BR-T610 BR-T4010 BR-T4000	With POWER MODULATOR* model BR-T780 with SM-PM70 BR-T670 with SM-PM70 BR-T610 with SM-PM70 BR-T4010 with SM-PM40 BR-T4000 with SM-PM40 BR-R573 with SM-PM70 BR-R463 with SM-PM40 BR-R353 with SM-PM70	BR-C6060-F BR-C6050-F BR-C6000 BR-C3010 BR-C3000
V-BRAKE Levers (2-finger)				
ST-M4000 ST-EF41 ST-TX800 ST-M370 ST-M310 ST-EF510 ST-EF500 ST-EF65 ST-EF51	BL-T610 BL-M571 BL-T4000 BL-MX70	✓	✓	
V-BRAKE Levers (3-finger)				
ST-T4000 ST-T3000	BL-T780 BL-T611 BL-T670 BL-T780-B BL-T4010 BL-T670-B		✓	
Brake Levers with switch				
ST-R240	BL-4600 BL-R780 BL-4700 BL-R3000 BL-R2000 BL-2400	✓	✓	NOTE
V-BRAKE lever with switch				
ST-M310 (4-finger) ST-EF65 (4-finger) ST-EF510 (4-finger) ST-EF500 (4-finger) BL-C6000			✓	NOTE
BL-C6010 SB-C6000-8 SB-C3000-7				✓

* POWER MODULATOR must be used for front brake



The "NO!" symbols indicate combinations that should not be used under any circumstances.

NOTE

This combination will not provide the sufficient amount of braking force.

Brake lever with switch compatibility

Four finger brake levers such as brake levers are equipped with a switch to change between the V-BRAKE with modulator mode (for example with SM-PM40) and the caliper brake or roller brake mode.

For V-BRAKE (with POWER MODULATOR) mode C-468

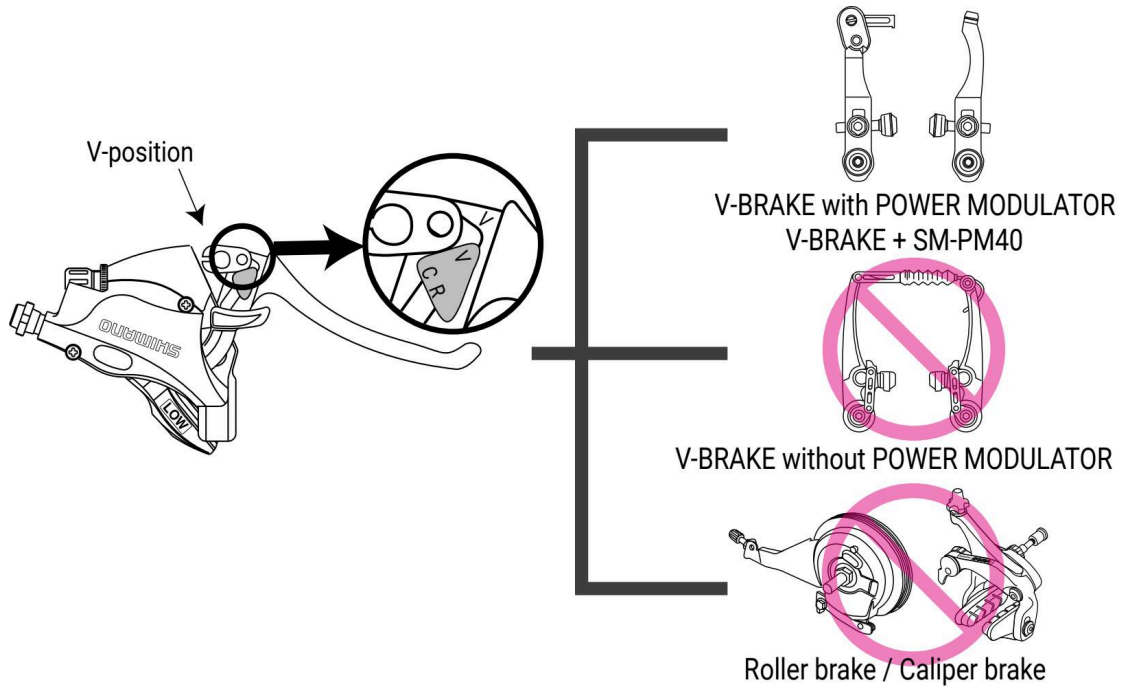

For Caliper brake / Roller brake C-469

BL-C6010

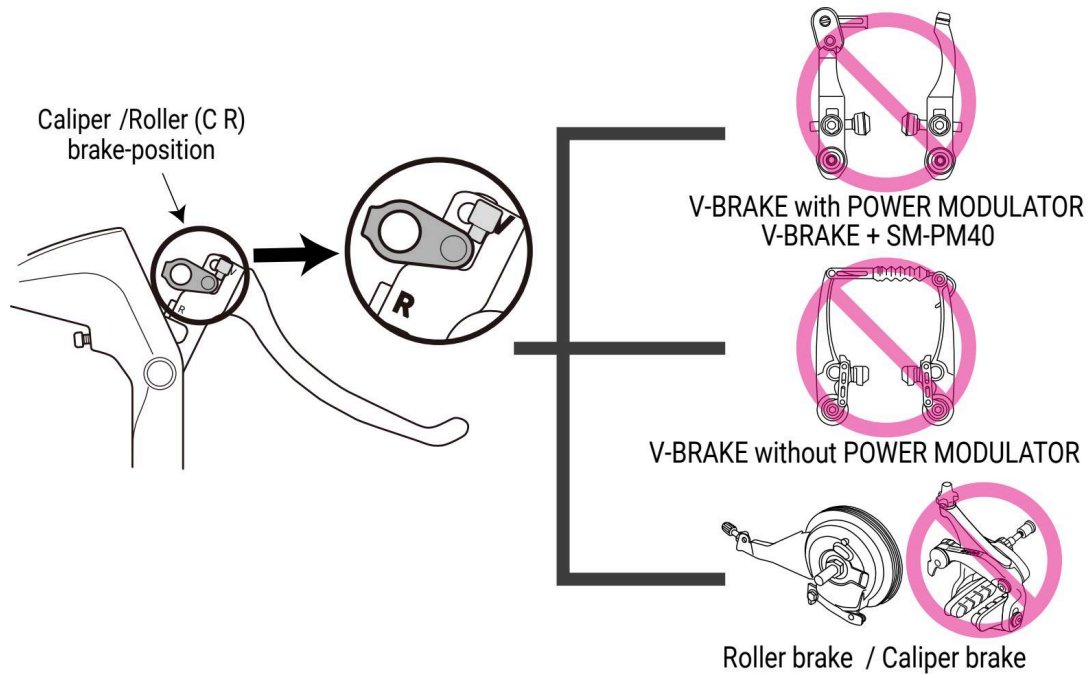

Other models

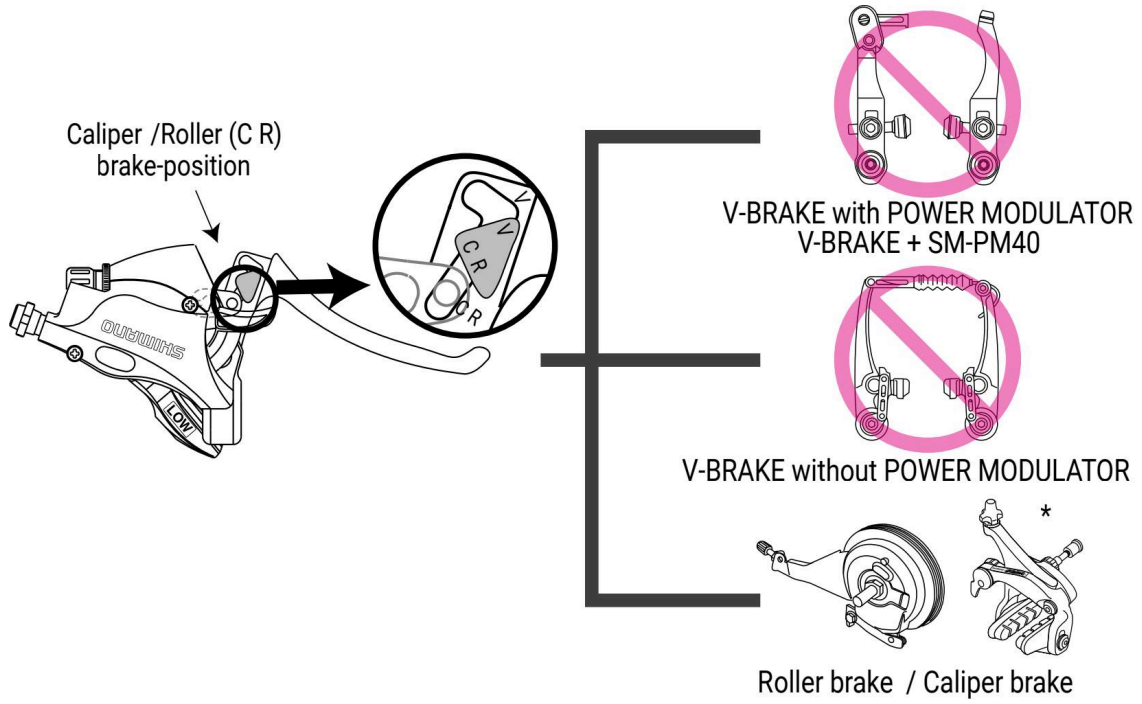

* 3 types of caliper brake is available (SLR-EV / NEW SUPER SLR / SUPER SLR)
Please refer Spec Hand Book for caliper brake compatibility.

Some models can't be used with roller brake, please refer to [C-466](#) for more information.

WARNING

If the mode is not matched to the type of brake being used, this could result in inadequate or excessive braking power. Please proceed with caution when selecting the correct mode for the corresponding brake.

FREEHUB and cassette spline compatibility

C-731

The table below does not include LINKGLIDE cassette. See [C-649](#) for LINKGLIDE cassette.

FREEHUB			Compatible cassette type					
Free unit type	Number of effective spline teeth	Outer body length (mm)	MTB		ROAD		All	
			12-speed	11-speed	12-speed	11-speed	10/9/8-speed	7-speed
MICRO SPLINE	23	26	✓	-	-	-	-	-
HG spline L2 (ROAD 12-speed dedicated)	18	37.65	-	-	✓	-	-	-
HG spline L (ROAD 12/11-speed)	9	36.75	-	✓ *1	✓	✓ *3	✓ *2	-
HG spline M (10/9/8-speed, MTB 11-speed)	9	34.9	-	✓	-	- *4	✓ *5	-
HG spline S (7-speed)	9	31	-	-	-	-	-	✓

*1 Need 1.85 mm low spacer.

*2 Need 1.85 mm low spacer and 1.0 mm spacer for the cassette below.

[CS-7900](#) / [CS-7800](#) / [CS-6700](#) / [CS-6600](#) / [CS-5700](#) / [CS-5600](#) (1.0 mm spacer is included)

*3 CS-HG800 / CS-HG700 of ROAD 11-speed are compatible with HG spline L by installing 1.85 mm spacer.

*4 CS-HG800 / CS-HG700 of ROAD 11-speed are compatible with HG spline M.

*5 Need 1.0 mm spacer for the 10-speed ROAD cassettes below.

[CS-7900](#) / [CS-7800](#) / [CS-6700](#) / [CS-6600](#) / [CS-5700](#) / [CS-5600](#)

Outer body length

Outer body length is length from the contact surface of the cassette of the free unit to the tip of the free unit.

MICRO SPLINE

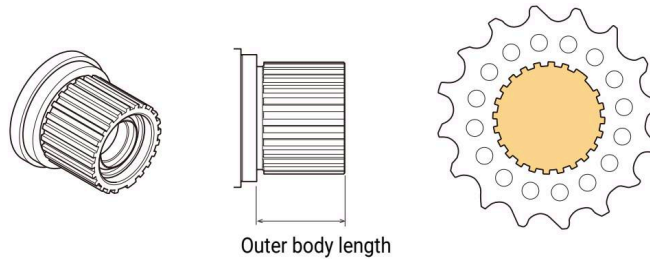

HG spline L2

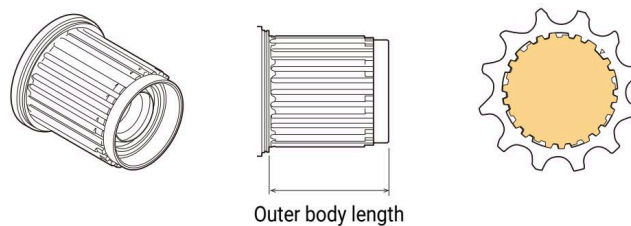

HG spline L/M/S

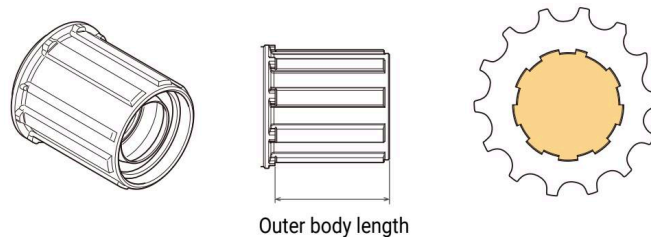

ROAD 12/11-speed FREEHUB compatibility

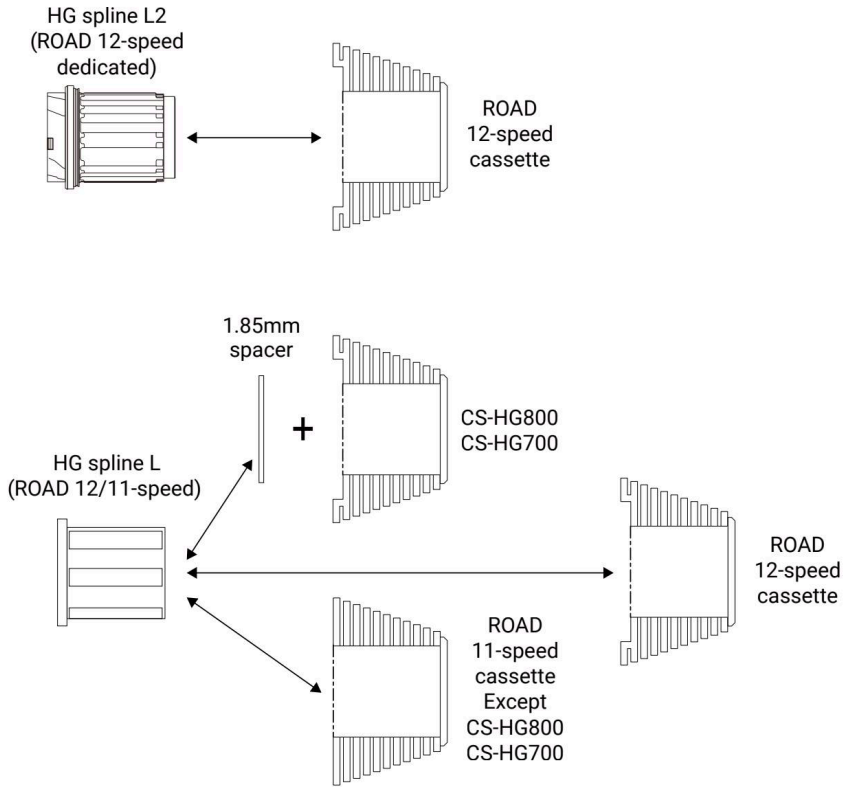

MTB 11-speed FREEHUB compatibility

MTB 11-speed wheel and FREEHUB have same spline shape with 10, 9, 8-speed FREEHUB.

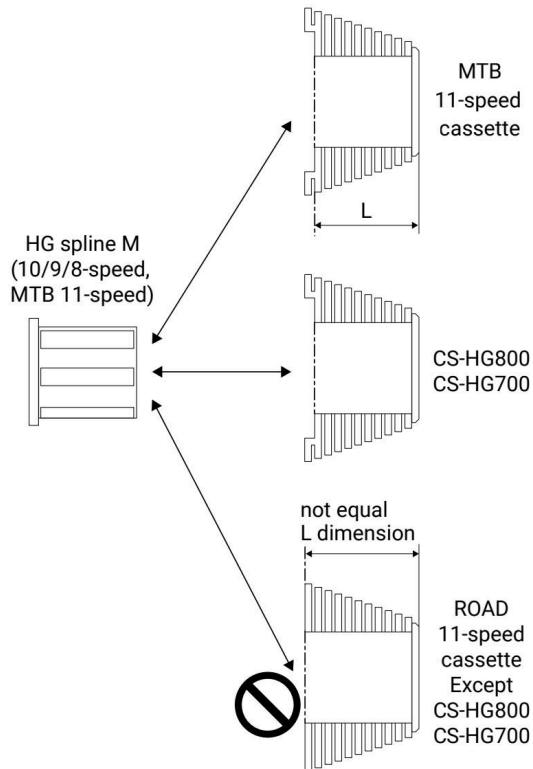

Compatibility between rear derailleur and cassette gear teeth [ROAD, Gravel, METREA]

12-speed C-648

Gear teeth	RD-R9250	RD-R8150	RD-R7100	RD-R7150
11-30T	✓	✓	-	-
11-34T	✓	✓	✓	✓
11-36T	-	-	✓	✓

Gear teeth	RD-RX820	RD-RX822	RD-RX822	RD-RX825
	-	GS	SGS	-
	Front double	Front single	Front single	Front double
10-45T	-	✓	-	-
10-51T	-	-	✓	-
11-34T	✓	-	-	✓
11-36T	✓	-	-	✓

11-speed C-255

Gear teeth	RD-R9100 RD-R9150	RD-R8000 RD-R8050		RD-R7000		RD-9000	RD-6800 RD-6870 RD-5800	
	-	SS	GS Front double	SS	GS Front double	SS	SS	GS Front double
11-23T	-	-	-	-	-	✓	✓	-
11-25T	✓	✓	-	-	-	✓	✓	-
11-28T	✓	✓	✓	✓	✓	✓	✓	✓
11-30T	✓	✓	✓	✓	✓	-	-	✓
11-32T	-	-	✓	-	✓	-	-	✓
11-34T	-	-	✓	-	✓	-	-	-
11-40T	-	-	-	-	-	-	-	-
11-42T	-	-	-	-	-	-	-	-
12-25T	✓	✓	-	✓	-	✓	✓	-
12-28T	✓	✓	✓	-	✓	✓	✓	✓
14-28T	✓	✓	-	✓	-	✓	✓	-

Gear teeth	RD-RX800 RD-RX805	RD-RX810 RD-RX815	RD-RX812 RD-RX817	RD-U5000-SS
	GS Front double	Closer Front double	Wider Front single	SS
11-23T	-	-	-	-
11-25T	-	-	-	-
11-28T	✓	-	-	✓
11-30T	✓	✓	-	✓
11-32T	✓	✓	-	✓
11-34T	✓	✓	-	-
11-40T	-	-	✓	-
11-42T	-	-	✓	-
12-25T	-	-	-	-
12-28T	-	-	-	-
14-28T	-	-	-	-

10-speed C-256

Gear teeth	RD-4700			RD-4601			RD-RX400
	SS	GS Front double	GS Front triple	SS	GS Front double	GS Front triple	Closer Front double
11-25T	✓	-	✓	✓	-	✓	-
11-27T	✓	-	✓	✓	✓	✓	-
11-28T	-	✓	✓	✓	✓	✓	-
11-32T	-	✓	✓	-	✓	-	✓
11-34T	-	✓	-	-	-	-	✓
11-36T	-	-	-	-	-	-	✓
12-25T	✓	-	✓	✓	-	✓	-
12-27T	✓	-	✓	✓	✓	✓	-
12-28T	✓	✓	✓	✓	✓	✓	-
12-30T	-	✓	✓	✓	✓	✓	-
13-25T	✓	-	✓	✓	-	✓	-
14-25T	✓	-	-	✓	-	✓	-

9-speed C-257

Gear teeth	RD-R3000		
	SS	GS Front double	GS Front triple
11-25T	✓	-	-
11-28T	✓	✓	✓
11-30T	✓	✓	✓
11-32T	✓	✓	✓
11-34T	-	✓	-
12-25T	✓	-	-
12-27T	✓	-	-
13-25T	✓	-	-
14-25T	✓	-	-

8-speed C-258

Gear teeth	RD-R2000		
	SS	GS Front double	GS Front triple
11-28T	✓	✓	✓
11-30T	✓	✓	✓
11-32T	✓	✓	✓
11-34T	-	✓	-
12-25T	✓	-	✓
13-26T	✓	-	-

7-speed C-259

Gear teeth	RD-A070 SMART CAGE	
	11-28T	✓
12-28T	✓	
13-28T	✓	
14-28T	✓	

LINKGLIDE cassette and FREEHUB compatibility

C-649

LINKGLIDE cassette are not compatible with MICRO SPLINE FREEHUB.





Freewheel body type	FREEHUB spec.	Model No.	CS-LG700-11 CS-LG600-11 CS-LG400-11	CS-LG600-10 CS-LG400-10 CS-LG300-10	CS-LG400-9 CS-LG300-9
HG spline M (10/9/8-speed, MTB 11-speed)	O.L.D. 148 mm, E-THRU type	FH-M8010-B			
		FH-M6010-B			
		FH-TC600-HM-B	✓	✓	✓
		FH-TC500-HM-B			
		FH-MT400-B			
	O.L.D. 141 mm, Quick release type	FH-MT200-B			
	O.L.D. 150 mm, E-THRU type	FH-M825	✓	✓	✓
	O.L.D. 135 mm, E-THRU type	FH-M820	- *2	✓	✓
	O.L.D. 142 mm, E-THRU type	FH-M8010	- *2		
		FH-M6010		✓	✓
		FH-MT400			
		FH-TC500-HM	✓	✓	✓
	O.L.D. 135 mm, Quick release type	FH-M9000			
		FH-M8000			
		FH-M6000			
		FH-M4050			
		FH-M3050			
		FH-RM35			
		FH-TX505-8			
		FH-M756-A	- *2	✓	✓
		FH-M525			
		FH-M475			
		FH-TX506			
FH-T610					
FH-T3000					
FH-TX500-8-QR					
FH-TX500-8-NT					
FH-QC400-HM	✓	✓	✓		
FH-QC300-HM					
O.L.D. 130 mm, Quick release type	FH-RS300	- *2	✓	✓	
HG spline L (ROAD 12/11-speed)	O.L.D. 142 mm, E-THRU type	FH-R7070			
		FH-RS770	✓ *1	✓ *1	✓ *1
		FH-RS470			
	O.L.D. 135 mm, Quick release type	FH-UR600	✓ *1	✓ *1	✓ *1
	O.L.D. 130 mm, Quick release type	FH-R7000			
		FH-RS400	- *2	✓ *1	✓ *1

*1 Need low spacer (1.85 mm.)

*2 Interference may occur with the rear derailleur and spokes.

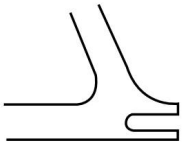
Available combinations of the dropout, sprocket and crankset for designing the frame

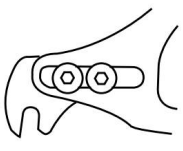
C-471

Dropout design	A	Reversed (BMX) type, without derailleur hanger	
	B	Standard type, without derailleur hanger	
	C	Adjustable disc brake mount / Eccentric bottom bracket	
	D	Vertical type, with derailleur hanger	
Compatibility	NR: Not recommend		-
Crankset	E	FC-C6000	-
	F	FC-S501: Double guard spec	-
	G	FC-S501: Single guard spec	-
	K	SM-CRE61 / SM-CRE50	-
CN	H	CN-NX10 (1/2 x 1/8 inch) or HG 8S (1/2 x 3/32 inch)	-
	I	Super Narrow HG 9S	-
	J	HG 8S (1/2 x 3/32 inch)	-

Series	Speed	Brake type	Dropout design	Compatibility	Chain tensioner *5	Sprocket	FC	CN	additional condition
ALFINE	11S / 8S	Disc brake	A	NR	-	-	-	-	*1
			B	NR	-	-	-		
			C	OK	-	SM-GEAR	G	J	-
			D	OK	CT-S500	CS-S500	F	I	-
		V-BRAKE	A	OK	-	SM-GEAR	G	J	-
			B	OK	-	SM-GEAR	G	J	-
			C	OK	-	SM-GEAR	G	J	-
			D	OK	CT-S500	CS-S500	F	I	-
NEXUS	8S / 7S	Disc brake	A	NR	-	-	-	-	*1
			B	NR	-	-	-		
			C	OK	-	SM-GEAR	G	J	-
			D	OK	CT-S500	CS-S500	F	I	-
	8S / 7S / 3S (except 3D)	Roller brake V-BRAKE	A	OK	-	SM-GEAR	E	H	-
			B	OK	-	SM-GEAR	G	J	-
			C	OK	-	SM-GEAR	E	H	-
			D	NR	CT-S500 (except 3s)	CS-S500	F	I	*2
		Coaster brake	A	OK	-	SM-GEAR	E	H	-
			B	OK	-	SM-GEAR	G	J	-
			C	OK	-	SM-GEAR	E	H	-
			D	NR	-	-	-	-	*3
				NR	-	-	-	-	*4
				NR	-	-	-	-	-
				NR	-	-	-	-	-
				NR	-	-	-	-	-
	3D	Disc brake	A	NR	-	-	-	-	*1
			B	NR	-	-	-		
			C	OK	-	SM-GEAR	G	J	-
			D	OK	-	CS-S500	F	I	-
		V-BRAKE	A	OK	-	SM-GEAR	G	J	-
			B	OK	-	SM-GEAR	G	J	-
			C	OK	-	SM-GEAR	G	J	-
			D	OK	-	CS-S500	F	I	-
5S for E-BIKE	Disc brake	A	NR	-	-	-	-	*1	
		B	NR	-	-	-			
		C	OK	-	CS-C7000	K	J	-	
		D	NR	-	-	-	-	-	
	Roller brake V-BRAKE	A	OK	-	CS-C7000	K	J	-	
		B	OK	-	CS-C7000	K	J	-	
		C	OK	-	CS-C7000	K	J	-	
		D	NR	-	-	-	-	-	
	Coaster brake	A	OK	-	CS-C7000	K	J	-	
		B	OK	-	CS-C7000	K	J	-	
		C	OK	-	CS-C7000	K	J	-	
		D	NR	-	-	-	-	-	

*1 Special disc brake mount design is needed.

*2 without chain guard for hub gear side.

*3 Structure of CT-S500 can't transfer chain tension by back pedaling.

*4 Not enough force of fixation against back pedaling power.

*5 Chain tensioners are not compatible with MU-UR510.

Mechanical internal geared hub / SM (CJ) COMPATIBILITY CHART

C-647

Internal Geared Hub (SG)		Spec.	Small Parts Set (SM)	Cassette Joint (CJ) * CJ is included in SM parts set
ALFINE-11	SG-S7001-11	11s, Disc brake, Premium	SM-S700 SM-S700-BD *1	CJ-S700 CJ-S700-BD *1
ALFINE-8	SG-S7001-8	8s, Disc brake, Premium	SM-S7000-8 SM-S7000-8BD *1	CJ-S7000-8 CJ-S7000-8BD *1
INTER-8	SG-C6011-8R	8s, Roller brake, Premium	SM-8S31 SM-8S31BD *1	CJ-8S20 / CJ-8S40 CJ-8S20BD *1
	SG-C6011-8V	8s, V-BRAKE, Premium		
	SG-C6001-8R	8s, Roller brake		
	SG-C6001-8V	8s, V-BRAKE		
	SG-C6001-8C	8s, Coaster brake		
	SG-C6001-8D	8s, Disc brake		
	SG-C6001-8CD	8s, Coaster brake & Disc brake		
INTER-7	SG-C3001-7R	7s, Roller brake	SM-7R45 SM-7C25 *1	CJ-NX10 / CJ-NX40
		7s, V-BRAKE		
	SG-C3001-7C	7s, Coaster brake	SM-7C25	CJ-NX10 / CJ-NX40
	SG-C3001-7D	7s, Disc brake	SM-7R45 SM-7C25 *1	CJ-NX10 / CJ-NX40
INTER-5E	SG-C7000-5R	5s, Roller brake, Premium	SM-C7000-5 SM-C7000-5BD *1	CJ-C7000-5 CJ-C7000-5BD *1
	SG-C7000-5V	5s, V-BRAKE, Premium		
	SG-C7000-5C	5s, Coaster brake, Premium		
	SG-C7000-5D	5s, Disc brake, Premium		
	SG-C7000-5CD	5s, Coaster brake & Disc brake		
INTER-5	SG-5R30 (Japan Only)	5s, Roller brake, Japan only	SM-5S30	CJ-8S20 / CJ-8S40
	SG-5R30-VS (Japan Only)	5s, V-BRAKE, Japan only		
	SG-5R35 (Japan Only)	5s, Roller brake, Alloy body, Japan only		
	SG-5R35-VS (Japan Only)	5s, V-BRAKE, Alloy body, Japan only		
INTER-3	SG-3R42 (Japan Only)	3s, Roller brake, Japan only	SM-3R40	-
	SG-3R40 (Japan Only)	-		
	SG-3R40	3s, Roller brake	SM-3R40	SM-BC03 SM-BC06
	SG-3C41	3s, Coaster brake	SM-3R41	-
	SG-3D55	3s, Disc brake	SM-3D55	SM-BC03 SM-BC06
	SG-3R75	3s, Roller brake, Premium	SM-3S70	CJ-NX10 / CJ-NX40

*1 Dedicated specs for belt drive system

Sprocket and chain combination

C-608

Series	Sprocket		Chain
	Model No.	Gear thickness (mm)	Model No.
ALFINE	CS-S500	2.0	CN-E6070 CN-HG93 CN-HG53
NEXUS	SM-GEAR (2.3 mm) CS-C7000	2.3	CN-HG71 CN-HG40
	SM-GEAR (3.0 mm)	3.0	CN-NX10

Compatibility for DIN 79010:2020-02

C-672

DIN 79010:2020-02

Fahrräder - Transport- und Lastenfahrrad - Anforderungen und Prüfverfahren für ein- und mehrspurige
Fahrräder

(Cycles - Transportation bikes and cargo bikes - Requirements and test methods for single- and multi-track
cycles)

Products		Model No.	DIN 79010:2020-02 (Type 1: Single Track) conformance
BRAKE (BR, RT)	Group #1	BR-M9120 / BR-M8120 / BR-M7120 + RT-MT900 / RT-EM910	YES with conditions (*1)
	Group #2	BR-M9120 / BR-M8120 / BR-M7120 + RT-MT800 / RT-EM810	
	Group #3	BR-M9120 / BR-M8120 / BR-M7120 + SM-RT86	
	Group #4	BR-M6120 + SM-RT30 / RT-EM300 / SM-RT66	
	Group #5	BR-MT520 / BR-MT420 + SM-RT30 / RT-EM300 / SM-RT66	
HUB (HB, FH, SG)	FH	FH-M**** / MT*** / TX*** / RS*** / UR*** series	YES (*SHIMANO can't guarantee assembled wheel performance. Please confirm wheel performance by bike manufacturer.)
	SG	SG-C7000-5D / SG-C7050-5D / SG-C6001-8D / SG-C6061-8D SG-C3001-7D	
	HB	HB-M**** / MT*** / TX*** / RS*** series	
	DH	All	
OTHERS	All not mentioned above (DU, CS, CN, RD, FC, etc.)	All	NO YES No special requirement if compare with ISO/EN4210-2 2015

(*1) conditions

Product Spec requirements

	Brake pad	RT size	Hose length (*Please consider Brake Lever reach adjustment)
Group #1,2,3	Resin pad w/ radiator fin	203 mm (L size)	2200 mm or less (Tire outer diameter = 660 mm or less) 2400 mm or less (Tire outer diameter = 559 mm or less) 2700 mm or less (Tire outer diameter = 406 mm or less)
		180 mm (M size)	1300 mm or less (Tire outer diameter = 660 mm or less) 2000 mm or less (Tire outer diameter = 559 mm or less) 2400 mm or less (Tire outer diameter = 406 mm or less)
Group #4	Resin pad w/o radiator fin	203 mm (L size)	2200 mm or less (Tire outer diameter = 660 mm or less) 2400 mm or less (Tire outer diameter = 559 mm or less) 2700 mm or less (Tire outer diameter = 406 mm or less)
		180 mm (M size)	1300 mm or less (Tire outer diameter = 660 mm or less) 2000 mm or less (Tire outer diameter = 559 mm or less) 2400 mm or less (Tire outer diameter = 406 mm or less)
Group #5	Resin pad w/o radiator fin	203 mm (L size) 180 mm (M size)	3000 mm or less (Tire outer diameter = 660 mm or less)

Limitation & adjustment

	RT size	DIN 79010:2020-02 5.5.2.2.2 Weight factor "c" (*2)	Brake lever adjustment
Group #1	203 mm (L size)	c = 1.5	Brake lever reach adjustment might be required to follow minimum braking force value of 5.5.1.3
	180 mm (M size)	c = 1.4	
Group #2	203 mm (L size)	c = 1.4	
	180 mm (M size)	c = 1.3	
Group #3	203 mm (L size)	c = 1.3	
	180 mm (M size)	c = 1.1	
Group #4,5	203 mm (L size)	c = 1.1	
	180 mm (M size)	c = 0.9	

(*2) Refer to DIN 79010:2020-02 5.5.2.2.2 about "c" value.

c: weight factor which is defined by bike design. $c = (AL: \text{axle load}) / (M: 100 \text{ kgf as basic value})$.

For example, axle load is allowed till 150 kgf if $c = 1.5$.

Spoke protector

C-491

Select the spoke protector after checking the chart below.

It is decided by hole number of hub and number of the gear teeth, other than multiple freewheel.

Cassette		Spoke protector model																			
		Flange diameter of rear hub (FH side)																Spoke hole number		Spoke hole number	
		53.8 mm								70.6 mm											
Speed	Model No.	Number of largest sprocket teeth											Spoke hole number						Spoke hole number		
		25T	28T	30T	32T	34T	36T	40T	42T	45T	46T	51T	28H	32H	36H	28H	32H	36H			
12-speed	CS-M9101	-	-	-	-	-	-	-	-	✓	-	✓	-	-	-	-	-	-			
	CS-M9100	-	-	-	-	-	-	-	-	-	-	✓	-	-	-	-	-	-			
	CS-M8100	-	-	-	-	-	-	-	-	✓	-	✓	-	-	-	-	-	-			
	CS-M7100	-	-	-	-	-	-	-	-	✓	-	✓	-	-	-	-	-	-			
	CS-M6100	-	-	-	-	-	-	-	-	-	-	✓	-	-	-	-	-	-			
11-speed	CS-M9001	-	-	-	-	-	-	✓	-	-	-	-	-	-	-	-	-	-			
	CS-M8000	-	-	-	-	-	-	✓	✓	-	✓	-	-	-	-	-	-	-			
	CS-M7000	-	-	-	-	-	-	✓	✓	-	✓	-	-	-	-	-	-	-			
	CS-M5100	-	-	-	-	-	-	-	✓	-	-	✓	-	-	-	-	-	-			
	CS-M4100	-	-	-	-	-	-	-	✓	-	✓	-	-	-	-	-	-	-			
10-speed	CS-M771-10	-	-	-	✓	✓	✓	-	-	-	-	-	-	CP-FH56	CP-FH53	-	CP-FH76	CP-FH76			
	CS-HG81-10	-	-	-	✓	✓	✓	-	-	-	-	-	-	CP-FH56	CP-FH53	-	CP-FH76	CP-FH76			
	CS-HG500-10	✓	✓	-	✓	✓	-	-	✓	-	-	-	-	-	-	-	-	-			
	CS-HG50-10	-	-	-	-	-	✓	-	-	-	-	-	-	-	CP-FH56	CP-FH53	-	-	-		
9-speed	CS-HG400-9	-	-	-	-	-	✓	-	-	-	-	-	-	CP-FH56	CP-FH53	-	CP-FH76	CP-FH76			
	CS-HG300-9	-	-	-	-	-	✓	-	-	-	-	-	-	CP-FH56	CP-FH53	-	CP-FH76	CP-FH76			
	CS-HG201-9	-	-	-	✓	✓	-	-	-	-	-	-	CP-WH12	CP-FH56	CP-FH53	-	CP-FH76	CP-FH76			
	CS-HG200-9	-	-	-	-	-	-	-	-	-	-	-	-	CP-FH35	CP-FH50	-	CP-FH76	CP-FH76			
	CS-HG400-9	-	✓	-	-	-	-	-	-	-	-	-	-	CP-FH35	CP-FH50	-	CP-FH76	CP-FH76			
	CS-HG300-9	-	✓	-	-	-	-	-	-	-	-	-	-	CP-FH35	CP-FH50	-	CP-FH76	CP-FH76			
8-speed	CS-ROAD	-	✓	-	-	-	-	-	-	-	-	-	CP-FH08	CP-FH35	CP-FH31	-	-	-			
	CS-HG60-81	-	-	-	-	✓	-	-	-	-	-	-	CP-WH12	CP-FH56	CP-FH53	-	CP-FH76	CP-FH76			
	CS-HG51-8	-	✓	✓	-	-	-	-	-	-	-	-	CP-FH40	CP-FH35	CP-FH50	-	-	-			
	CS-HG51-8	-	-	-	-	✓	-	-	-	-	-	-	CP-WH12	CP-FH56	CP-FH53	-	CP-FH76	CP-FH76			
	CS-HG41-8	-	-	✓	-	-	-	-	-	-	-	-	CP-FH40	CP-FH35	CP-FH50	-	-	-			
	CS-HG31-8	-	-	✓	-	-	-	-	-	-	-	-	CP-FH40	CP-FH35	CP-FH50	-	-	-			
	CS-HG41-8	-	-	-	✓	✓	-	-	-	-	-	-	CP-WH12	CP-FH56	CP-FH53	-	CP-FH76	CP-FH76			
	CS-HG31-8	-	-	-	✓	✓	-	-	-	-	-	-	CP-WH12	CP-FH56	CP-FH53	-	CP-FH76	CP-FH76			
7-speed	CS-HG400-8	-	-	-	-	-	✓	-	✓	-	-	-	-	-	-	-	-	-			
	CS-HG200-8	-	-	-	✓	-	-	-	-	-	-	-	CP-WH12	CP-FH56	CP-FH53	-	CP-FH76	CP-FH76			
	CS-HG41-7	-	✓	-	-	-	-	-	-	-	-	-	CP-FH40	CP-FH35	CP-FH50	-	-	-			
	CS-HG200-7	-	-	-	✓	-	-	-	-	-	-	-	-	CP-FH56	CP-FH53	-	CP-FH76	CP-FH76			
	CS-HG200-7	-	✓	-	-	-	-	-	-	-	-	-	-	CP-FH35	CP-FH50	-	-	-			

12-speed

Model No.	Cassette		Spoke protector model					
	Number of largest sprocket teeth		WH-M8100	WH-M8120	WH-MT620	WH-MT601	WH-MT501	WH-M9000 WH-M9020 WH-M8000 WH-M8020 WH-M8000-B WH-M8020-B
	45T	51T						
CS-M9101	✓	✓						-
CS-M9100	✓	✓	CP-WH28	CP-WH32 (for 10-45T) CP-WH29 (for 10-51T)	CP-WH31 (for 10-45T) CP-WRX8B CP-WH27 (for 10-51T)	CP-WH31 (for 10-45T) CP-WRX8B CP-WH27 (for 10-51T)	CP-WH31 (for 10-45T) CP-WRX8B CP-WH27 (for 10-51T)	-
CS-M8100	✓	✓						-
CS-M7100	✓	✓						-
CS-M6100	-	✓	-	-	-	-	-	-

Model No.	Cassette		Spoke protector model				
	Number of largest sprocket teeth		WH-MT600	WH-MT500	WH-MT66-29	WH-MT35 WH-MT35-275 WH-MT35-29 WH-MT15-A-275 WH-MT15-A-29	WH-RX880 (MICRO SPLINE)
	45T	51T					
CS-M9101	✓	✓	-	-	-	-	CP-WRX8B
CS-M9100	✓	✓	-	-	-	-	
CS-M8100	✓	✓	-	-	-	-	
CS-M7100	✓	✓	-	-	-	-	
CS-M6100	-	✓	-	-	-	-	

11-speed

Model No.	Cassette						Spoke protector model				
	Number of largest sprocket teeth						WH-M8100	WH-M8120	WH-MT620	WH-MT601	WH-MT501
	40T	42T	45T	46T	50T	51T					
CS-M9001	✓	-	-	-	-	-	-	-	-	-	-
CS-M8000	✓	✓	-	✓	-	-	-	-	-	-	-
CS-M7000	✓	✓	-	✓	-	-	-	-	-	-	-
CS-M5100	-	✓	-	-	-	✓	-	-	-	-	-
CS-LG700-11	-	-	✓	-	✓	-	-	-	-	-	-
CS-LG600-11	-	-	-	-	✓	-	-	-	-	-	-
CS-LG400-11	-	-	✓	-	✓	-	-	-	-	-	-

Model No.	Cassette						Spoke protector model				
	Number of largest sprocket teeth						WH-M9000 WH-M9020 WH-M8000 WH-M8020 WH-M8000-B WH-M8020-B	WH-MT600	WH-MT500	WH-MT66-29	WH-MT35 WH-MT35-275 WH-MT35-29 WH-MT15-A-275 WH-MT15-A-29
	40T	42T	45T	46T	50T	51T					
CS-M9001	✓	-	-	-	-	-	CP-WH17-A	CP-WH26	-	-	-
CS-M8000	✓	✓	-	✓	-	-	CP-WH17-A	CP-WH26	-	-	-
CS-M7000	✓	✓	-	✓	-	-	CP-WH17-A	CP-WH26	-	-	-
CS-M5100	-	✓	-	-	-	✓	CP-WH17-A (for 42T)	CP-WH26 (for 42T)	-	-	-
CS-LG700-11	-	-	✓	-	✓	-	-	-	-	-	-
CS-LG600-11	-	-	-	-	✓	-	-	-	-	-	-
CS-LG400-11	-	-	✓	-	✓	-	-	-	-	-	-

10-speed

Model No.	Cassette								Spoke protector model				
	Number of largest sprocket teeth								WH-M8100	WH-M8120	WH-MT620	WH-MT601	WH-MT501
	32T	34T	36T	39T	42T	43T	46T	48T					
CS-M4100	-	-	-	-	✓	-	✓	-	-	-	-	-	-
CS-M771-10	✓	✓	✓	-	-	-	-	-	-	-	-	-	-
CS-HG81-10	-	✓	✓	-	-	-	-	-	-	-	-	-	-
CS-HG500-10	-	-	-	-	✓	-	-	-	-	-	-	-	-
CS-HG50-10	-	-	✓	-	-	-	-	-	-	-	-	-	-
CS-LG600-10	-	-	-	-	-	✓	-	-	-	-	-	-	-
CS-LG400-10	-	-	-	✓	-	✓	-	✓	-	-	-	-	-
CS-LG300-10	-	-	-	✓	-	-	-	✓	-	-	-	-	-

Model No.	Cassette								Spoke protector model				
	Number of largest sprocket teeth								WH-M9000 WH-M9020 WH-M8000 WH-M8020 WH-M8000-B WH-M8020-B	WH-MT600	WH-MT500	WH-MT66-29	WH-MT35 WH-MT35-275 WH-MT35-29 WH-MT15-A-275 WH-M815-A-29
	32T	34T	36T	39T	42T	43T	46T	48T					
CS-M4100	-	-	-	-	✓	-	✓	-	-	-	-	-	-
CS-M771-10	✓	✓	✓	-	-	-	-	-	-	CP-WH16	CP-WH21	CP-WH16	CP-WH12
CS-HG81-10	-	✓	✓	-	-	-	-	-	-	CP-WH16	CP-WH21	CP-WH16	CP-WH12
CS-HG500-10	-	-	-	-	✓	-	-	-	-	-	CP-WH21	-	CP-WH19
CS-HG50-10	-	-	✓	-	-	-	-	-	-	CP-WH16	CP-WH21	CP-WH16	CP-WH12
CS-LG600-10	-	-	-	-	-	✓	-	-	-	CP-WH26	CP-WH21	-	-
CS-LG400-10	-	-	-	✓	-	✓	-	✓	-	-	-	-	-
CS-LG300-10	-	-	-	✓	-	-	-	✓	-	-	-	-	-

9-speed

Model No.	Cassette						Spoke protector model				
	Number of largest sprocket teeth						WH-M8100	WH-M8120	WH-MT620	WH-MT601	WH-MT501
	28T	32T	34T	36T	41T	46T					
CS-HG400-9 CS-HG300-9 CS-HG201-9 CS-HG200-9	-	✓	✓	✓	-	-	-	-	-	-	-
CS-HG400-9 CS-HG300-9	✓	-	-	-	-	-	-	-	-	-	-
CS-LG400-9	-	-	-	✓	✓	✓	-	-	-	-	-
CS-LG300-9	-	-	-	✓	✓	✓	-	-	-	-	-

Model No.	Cassette						Spoke protector model				
	Number of largest sprocket teeth						WH-M9000 WH-M9020 WH-M8000 WH-M8020 WH-M8000-B WH-M8020-B	WH-MT600	WH-MT500	WH-MT66-29	WH-MT35 WH-MT35-275 WH-MT35-29 WH-MT15-A-275 WH-MT15-A-29
	28T	32T	34T	36T	41T	46T					
CS-HG400-9 CS-HG300-9 CS-HG201-9 CS-HG200-9	-	✓	✓	✓	-	-	-	-	-	CP-WH16	CP-WH12
CS-HG400-9 CS-HG300-9	✓	-	-	-	-	-	-	-	-	CP-WH16	CP-WH08
CS-LG400-9	-	-	-	✓	✓	✓	-	-	-	-	-
CS-LG300-9	-	-	-	✓	✓	✓	-	-	-	-	-

Model No.	Speed				Number of largest sprocket teeth									
	9	10	11**	12	23T	25T	27T	28T	30T	32T*	34T	36T	40T	42T
WH-R9270-C60	-	-	-	✓	-	-	-	-	-	CP-WR92C		-	-	-
WH-R9270-C50 WH-R9270-C36	-	-	-	✓	-	-	-	-	-	CP-WR92A		-	-	-
WH-R9200-C60 WH-R9200-C50 WH-R9200-C36	-	-	-	✓	-	-	-	-	-	CP-W124		-	-	-
WH-R8170-C60 WH-R8170-C50 WH-R8170-C36	-	-	✓	✓	-	-	-	-	-	CP-WR81A		-	-	-
WH-RS710-C32 WH-RS710-C46	-	-	✓	✓	-	-	-	-	-	CP-WH24		CP-WR71A	-	-
WH-R9170-C60 WH-R9170-C40	-	✓	✓	-	-	-	-	-	-	CP-W1460		-	-	-
WH-R9100-C60 WH-R9100-C40	-	✓	✓	-	-	-	-	-	-	CP-W124		-	-	-
WH-R9100-C24	-	-	✓	-	CP-WH23	-	-	-	-	CP-W120		-	-	-
	-	✓	-	-	-	-	-	-	-	CP-W020		-	-	-
WH-RS770-C30	-	-	✓	-	-	-	-	-	-	CP-W1460		CP-W1460	-	-
	-	✓	-	-	-	-	-	-	-	CP-W1460		-	-	-
WH-RS700-C30	-	-	✓	-	-	-	-	-	-	CP-W124		CP-W124	-	-
	-	✓	-	-	-	-	-	-	-	CP-W124		-	-	-
WH-RS500 WH-RS300 WH-RS11	-	-	✓	-	CP-WH23			-	-	CP-W120	-	-	-	-
WH-RS11	-	✓	-	-	CP-W020			-	-	-	-	-	-	-
WH-9000-C24-TU WH-RS330-CL	-	-	✓	-	CP-W184			-	-	CP-W124	-	-	-	-
	-	✓	-	-	CP-W024			-	-	-	-	-	-	-
WH-RX830	-	✓	✓	-	-	-	-	-	CP-W1220		CP-WH14 CP-WH14A	-	-	-
WH-RX31	-	✓	✓	-	-	-	-	-	CP-W122		-	-	-	-
WH-RS100	-	✓	✓	-	-	-	-	-	CP-WH24		CP-FH53	-	-	-
WH-RS010-CL	-	✓	✓	-	-	-	-	-	CP-WH24		CP-FH53	-	-	-
WH-R501 WH-R501-A	✓	✓	-	-	CP-FH06		CP-FH31	CP-FH46	CP-WH24	-	-	-	-	-
WH-RS170	-	-	✓	-	CP-FH08		-	-	CP-WH12	-	-	-	-	-
	-	✓	-	-	CP-FH40 CP-FH41		CP-FH40 CP-FH41	CP-WH12	CP-WH12	-	-	-	-	-
WH-RS171 (700c/650b)	-	-	✓	-	CP-FH08		-	-	CP-WH12	-	-	-	-	-
	-	✓	-	-	CP-FH40 CP-FH41		CP-FH40 CP-FH41	CP-WH12	CP-WH12	-	-	-	-	-
WH-RX010-CL	-	-	✓	-	CP-FH08		-	-	CP-WH12	-	-	-	-	-
	-	✓	-	-	CP-FH40 CP-FH41		CP-FH40 CP-FH41	CP-WH12	CP-WH12	-	-	-	-	-
WH-RX010	✓	✓	-	-	CP-FH08		CP-FH40 CP-FH41	CP-WH12	-	-	-	-	-	-
WH-U5000	-	✓	✓	-	-	-	-	-	CP-W122		-	-	-	-
WH-RS370	-	✓	✓	-	-	-	-	-	CP-WH12		-	-	-	-
	-	✓	-	-	CP-WH41			CP-WH12	-	-	-	-	-	
WH-RX880 (HG spline L2)	-	-	-	✓	-	-	-	-	-	CP-WRX8A		-	-	-
WH-RX870	-	-	✓	✓	-	-	-	-	-	CP-WH30	-	-	CP-WH26	-
WH-RX570	-	✓	✓	-	-	-	-	-	CP-WH30		-	-	-	-
	-	✓	-	-	CP-WH41			CP-WH12	-	-	-	-	-	

* For compact crank set

** 11-speed : CS-R9100 / CS-R8000 / CS-R7000 / CS-6800 / CS-5800

Spoke protector for Road

Speed	Model No.	Number of largest sprocket teeth										Spoke holes number			
		21T	23T	24T	25T	26T	27T	28T	30T	32T	34T	24H	28H	32H	36H
8, 9, 10	Road	✓	✓	-	✓	-	-	-	-	-	-	CP-FH06	CP-FH08	CP-FH05	CP-FH06
		-	-	-	-	✓	-	-	-	-	-	CP-FH31	CP-FH08	CP-FH35	CP-FH31
		-	-	-	-	-	✓	✓	-	-	-	CP-FH31	CP-FH08	CP-FH35	CP-FH31
		-	-	-	-	-	-	-	✓	-	-	-	-	CP-FH45	CP-FH46
7	CS-HG200-7	-	-	-	-	-	-	✓	-	-	-	-	CP-FH35	CP-FH50	
	MF-TZ500-7 MF-TZ510-7 MF-TZ21	-	-	-	-	-	-	✓	-	-	-	-	-	CP-HG22/ MF-TZ500-7*/ MF-TZ21*	

Spoke protector is not available for Road 11-speed FREEHUB.

* w/ Spoke protector spec. is available

Compatibility chart of E-TUBE PROJECT Cyclist/Professional v5.3.2

2nd generation (Gen.2) battery management system

C-525

This is a compatibility table when using the following batteries.

- SHIMANO E-BIKE SYSTEMS Gen.2 battery
- Battery with hardware and firmware compatible with Gen.2 made by partner manufacturers.

* Gen.2 battery management system is not compatible with a battery with hardware and firmware compatible with conventional system made by partner manufacturers.

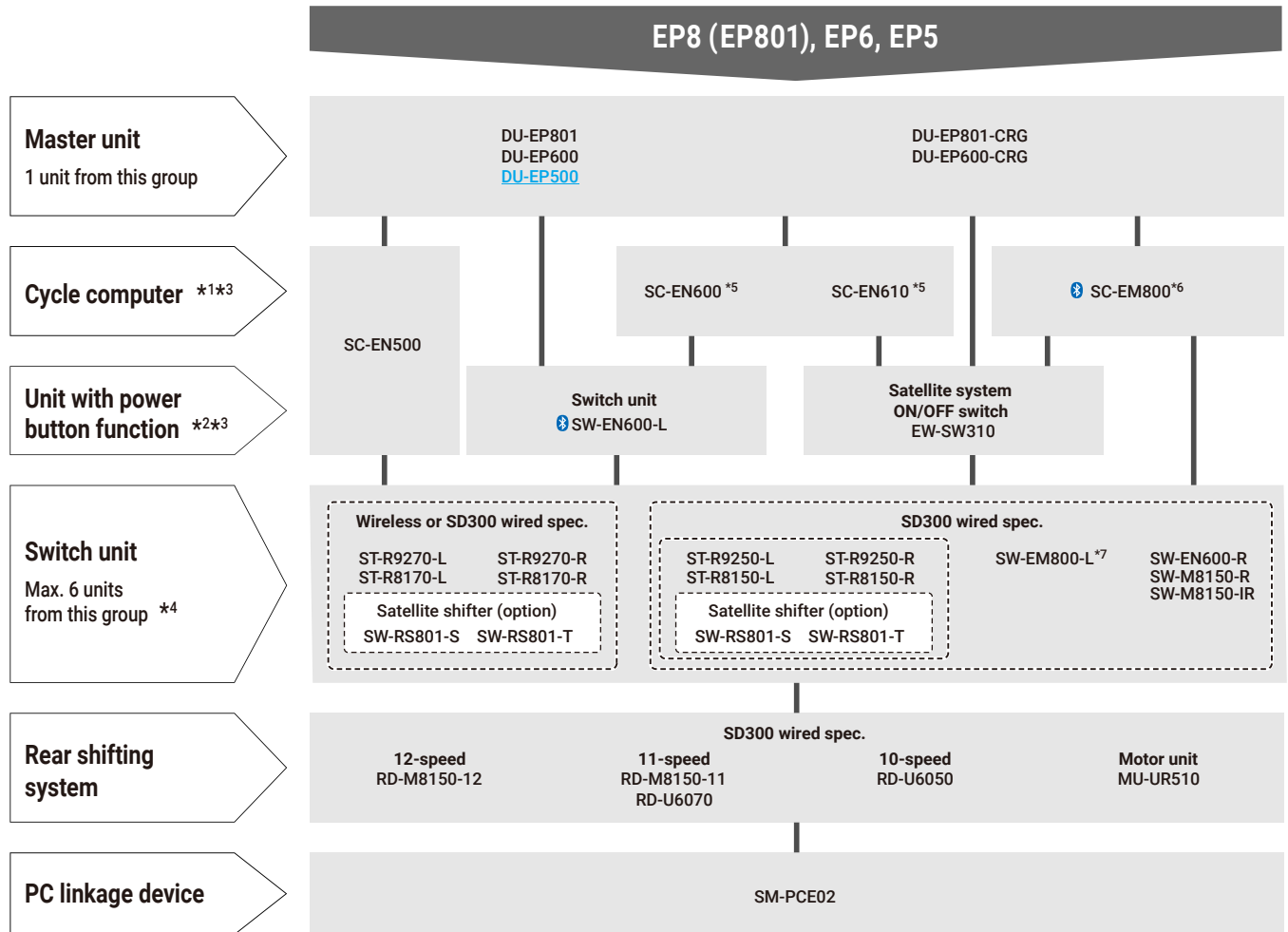

Limitation of function

- *1 When system has unit with power button function, cycle computer isn't mandatory.
- *2 When the cycle computer, switch unit, and other units has power ON / OFF function, the unit with power button function isn't mandatory.
- *3 When system has 3rd party CAN cycle computer, SHIMANO cycle computer and the unit with power button function isn't mandatory.
- *4 Switch units are defined by model no. [SW], [ST], and [EW-SW] in this chart.
- *5 Switch unit is mandatory for assist control. But E-TUBE PROJECT Factory is not compatible with the combination of cycle computer and switch unit.
- *6 When drive unit (US class 3) is connected, cycle computer can displays main screen (speed and assist bar) only.
- *7 Need to change switch setting by E-TUBE PROJECT to use as shift switch.

1st generation battery management system for partner manufacturers' battery

* This is a compatibility table when using a battery made by a partner manufacturer that ensures compatibility only by updating the firmware.

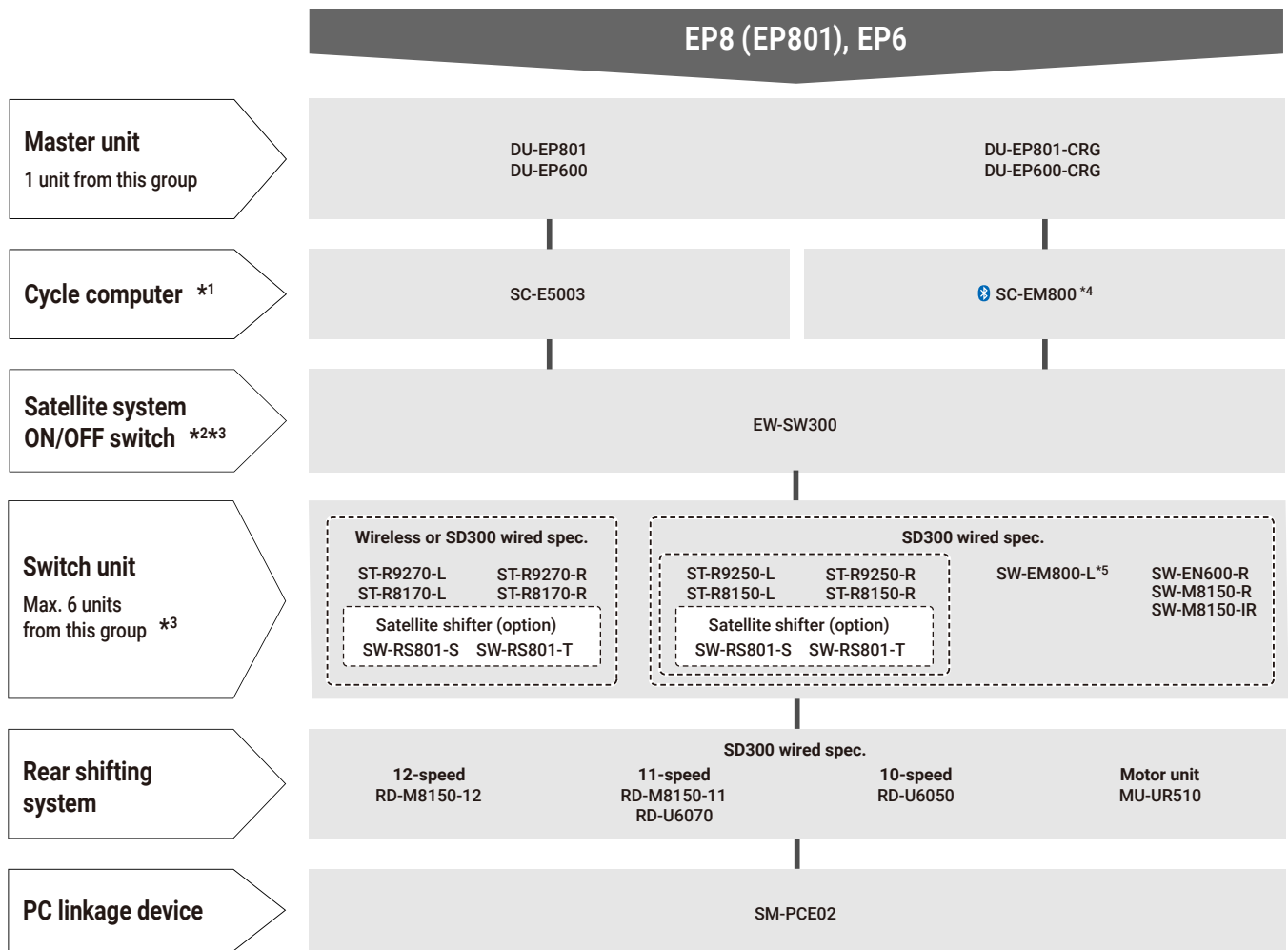

Limitation of function

*1 Cycle computer is mandatory.

*2 When power on/off function on other unit, satellite power on/off switch isn't mandatory.

*3 Switch units are defined by model no. [SW], [ST], and [EW-SW] in this chart.

*4 When drive unit (US class 3) is connected, cycle computer can displays main screen (speed and assist bar) only.

*5 Need to change Switch setting by E-TUBE PROJECT to use as shift switch.

1st generation battery management system

* This is a compatibility table when using the following batteries.

- SHIMANO E-BIKE SYSTEMS 1st generation battery
- Battery with hardware and firmware compatible with conventional system made by partner manufacturers.

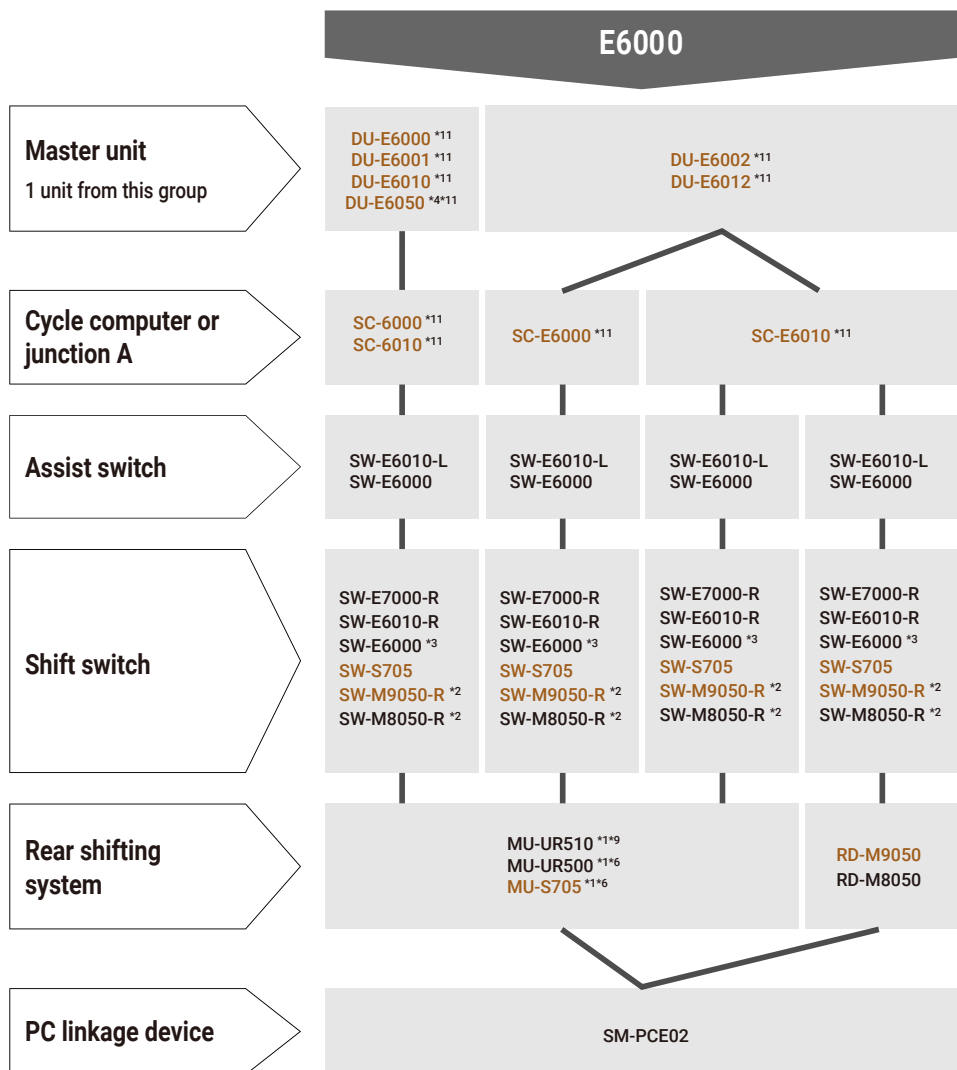

E8000/E8080

Master unit
1 unit from this group

DU-E8000
DU-E8080 *5

Cycle computer or junction A

SC-E6010 *11 SC-E8000 *8 SC-EM800 *9
SC-E7000
SC-E6100
SC-E5000 *10*11
SC-E5003 *9*10*11
EW-EN100

Assist switch

SW-E6010-L
SW-E6000 SW-EM800-L *9
SW-E8000-L
SW-E7000-L
SW-E6010-L
SW-E6000
SW-M9050-L
SW-M8050-L SW-EM800-L *9
SW-E8000-L
SW-E7000-L
SW-E6010-L
SW-E6000
SW-M9050-L
SW-M8050-L
ST-R8070-L
ST-RX815-L

Shift switch

SW-E7000-R
SW-E6010-R
SW-E6000 *3
SW-S705
SW-M9050-R
SW-M8050-R SW-E7000-R
SW-E6010-R
SW-E6000 *3
SW-S705
SW-M9050-R
SW-M8050-R SW-E7000-R
SW-E6010-R
SW-E6000 *3
SW-S705
SW-M9050-R
SW-M8050-R
ST-R8070-R
ST-RX815-R

Satellite system ON/OFF switch

EW-SW100
EW-SW300 *9

Rear shifting system

RD-M9050
RD-M8050 RD-M9050
RD-M8050 RD-M9050
RD-M8050
RD-RX815
RD-RX817
RD-R8050
RD-RX805

PC linkage device

SM-PCE02

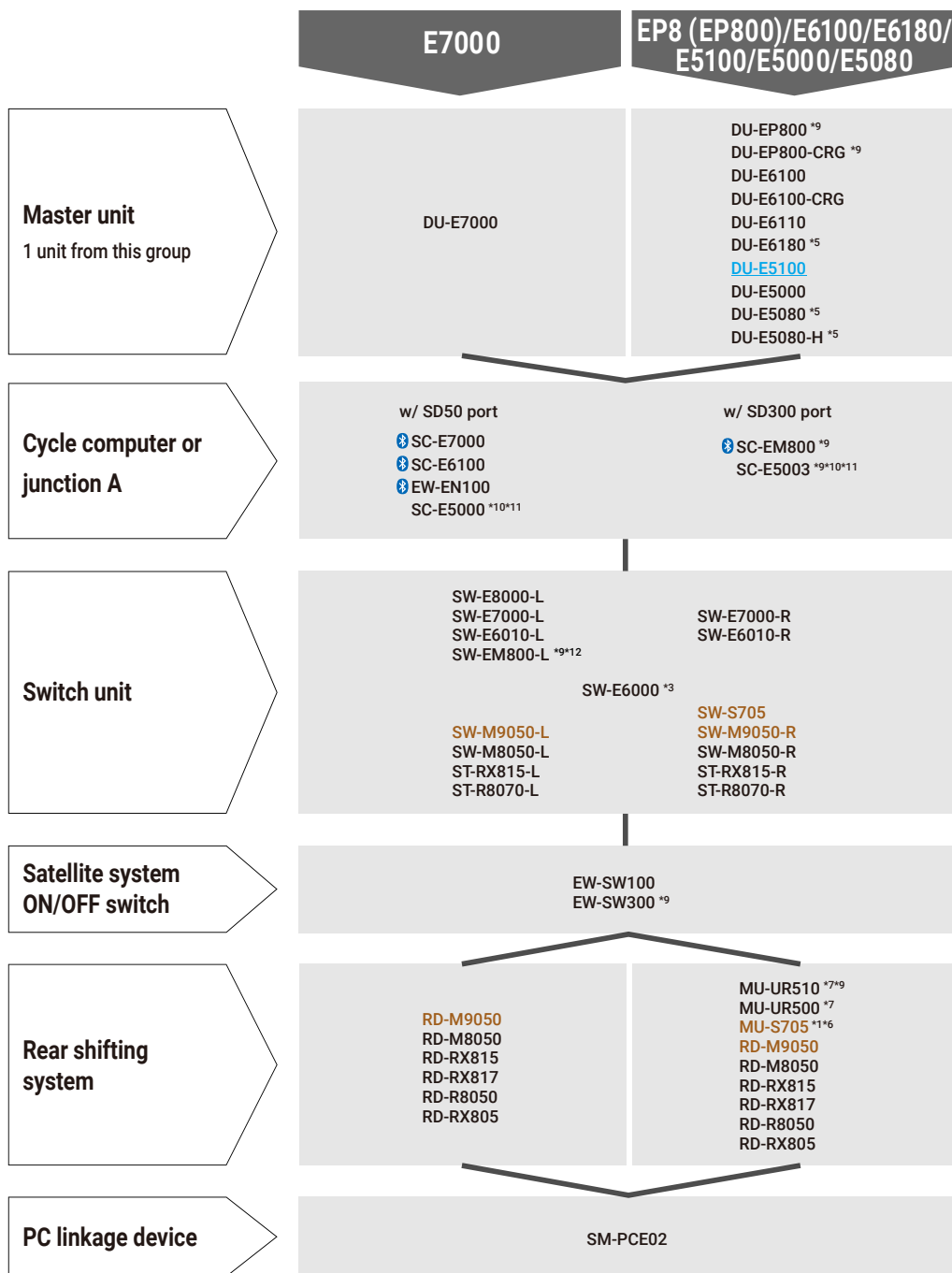

Limitation of function

- *1 Automatic gear shifting is available only with 8-speed internal geared hubs (Not available with rear derailleurs).
- *2 Not support automatic shift.
- *3 Need to change Switch setting by E-TUBE PROJECT.
- *4 North American market only.
- *5 Japanese market only.
- *6 Available only with 11-speed and 8-speed internal geared hubs.
- *7 Automatic gear shifting is available only with 8 speed and 5 speed internal geared hub system. (Not available with Rear Derailleur)
- *8 Not available in Japan market.
- *9 This unit has SD300 port, and needs EW-AD305 for connection with SD50 port unit.
- *10 SC-E5000, SC-E5003 is only for ø22.2 handlebar. Drop handlebar is unavailable.
- *11 Not supported by E-TUBE PROJECT Cyclist.
- *12 To use as a shift switch, the switch settings need to be changed in E-TUBE PROJECT.

DU-EP801 / DU-EP801-CRG / DU-EP800 / DU-EP800-CRG / DU-EP600 / DU-EP600-CRG / [DU-EP500](#) C-706

12-speed Rear derailleur spec.

Shifting system	Chain type	Rear sprocket	Crank arm	Chainring	Chain line (mm)	Chain guard	Chain device
HYPERGLIDE+ 12-speed *2 (Di2, Mechanical)	HG 12-speed	HYPERGLIDE+ 12-speed	FC-EM900 FC-M8150 FC-EM600 FC-EN500	SM-CRE80-12-SB 34T/36T	56.5	-	CD-EM800
				CR-EM800*1 32T	55	-	CD-EM800 w/o plate
				SM-CRE80-12-B 34T/36T/38T			CD-EM800 (Chain line: 55 mm)
				SM-CRE70-12-B 36T	53	-	CD-EM800 SM-CDE80 SM-CDE70
				SM-CRE80-12-B 34T/36T/38T			
				SM-CRE70-12-B 36T	50	-	-
				SM-CRE80-R 47T			
				SM-CRE70-12 42T	Double		

*1 For DU-EP800 and DU-EP800-CRG, it is necessary to replace the lock ring to Y7K79801T

*2 DU-EP800 and DU-EP800-CRG are not compatible with 12-speed Di2 drivetrain

11/10/9-speed Rear derailleur spec.

Shifting system	Chain type	Rear sprocket	Crank arm	Chainring	Chain line (mm)	Chain guard	Chain device
LINKGLIDE *1 (Di2, Mechanical)	LINKGLIDE HG 11-speed	LINKGLIDE 11/10/9-speed	FC-EM900 FC-M8150 FC-EM600 FC-EN500	SM-CRE80-B 34T/38T	55	-	CD-EM800 (Chain line: 55 mm)
				SM-CRE70-B 34T			
				SM-CRE80-B 34T/38T	53	-	CD-EM800 SM-CDE80 SM-CDE70
				SM-CRE70-B 34T			
				CR-ET600 38T/44T	50	Double	-
				SM-CRE80 34T/38T	50	-	SM-CDE80 w/o plate
				SM-CRE80 44T	50	Double	-
				SM-CRE80-R 47T	50	-	
				SM-CRE70 38T	50	-	SM-CDE80 w/o plate
	50	Double	-				
HG 11-speed (Di2, Mechanical)	LINKGLIDE HG 11-speed	HG 11-speed	FC-EM900 FC-M8150 FC-EM600 FC-EN500	SM-CRE80-B 34T/38T	55	-	CD-EM800 (Chain line: 55 mm)
				SM-CRE70-B 34T			
				SM-CRE80-B 34T/38T	53	-	CD-EM800 SM-CDE80 SM-CDE70
				SM-CRE70-B 34T			
				CR-ET600 38T/44T	50	Double	-
				SM-CRE80 34T/38T	50	-	SM-CDE80 w/o plate
				SM-CRE80 44T	50	Double	-
				SM-CRE80-R 47T	50	-	
				SM-CRE70 38T	50	-	SM-CDE80 w/o plate
	50	Double	-				
HG 10-speed (Mechanical)	HG 10-speed	HG 10-speed	FC-EM900 FC-M8150 FC-EM600 FC-EN500	SM-CRE80-B 34T/38T	55	-	CD-EM800 (Chain line: 55 mm)
				SM-CRE70-B 34T			
				SM-CRE80-B 34T/38T	53	-	CD-EM800 SM-CDE80 SM-CDE70
				SM-CRE70-B 34T			
				CR-ET600 38T/44T	50	Double	-
				SM-CRE80 34T/38T	50	-	SM-CDE80 w/o plate
				SM-CRE80 44T	50	Double	-
				SM-CRE80-R 47T	50	-	
				SM-CRE70 38T	50	-	SM-CDE80 w/o plate
	50	Double	-				
HG 9-speed (Mechanical)	HG 9-speed	HG 9-speed	FC-EM900 FC-M8150 FC-EM600 FC-EN500	SM-CRE70-B 34T	55	-	CD-EM800 (Chain line: 55 mm)
				SM-CRE70-B 34T	53		CD-EM800 SM-CDE80 SM-CDE70
				CR-ET600 38T/44T	50	Double	-
				SM-CRE80-R 47T	50	-	
				SM-CRE70 38T	50	-	SM-CDE80 w/o plate
	50	Double	-				

*1 DU-EP800 and DU-EP800-CRG are not compatible with LINKGLIDE Di2 drivetrain

Internal geared hub spec.

Shifting system	Chain type	Rear sprocket	Crank arm	Chainring	Chain line (mm)	Chain guard	Chain tensioner	
ALFINE INTER-11/8 (Di2, Mechanical)	HG 10/9-speed	CS-S500	FC-EM900 FC-M8150 FC-EM600 FC-EN500	CR-ET600 38T/44T	50	Double	CT-S510	
				SM-CRE61 38T/44T	46.5			
	HG 8-speed	SM-GEAR		CR-ET600 38T/44T	50	Single		
				SM-CRE61 38T/44T	46.5			
				CR-ET600 38T/44T	50	w/o		-
SM-CRE61 38T/44T	46.5							
NEXUS INTER-8 (Di2, Mechanical)	HG 10/9-speed	CS-S500	FC-EM900 FC-M8150 FC-EM600 FC-EN500	CR-ET600 38T/44T	50	Double	CT-S510	
				SM-CRE61 38T/44T	46.5			
	HG 8-speed Single speed (1/2 inch x 1/8 inch)	SM-GEAR		CR-ET600 38T/44T	50	Single		
				SM-CRE61 38T/44T	46.5			
				CR-ET600 38T/44T	50	w/o		-
SM-CRE61 38T/44T	46.5							
NEXUS INTER-7/3 (Mechanical)	HG 10/9-speed	CS-S500	FC-EM900 FC-M8150 FC-EM600 FC-EN500	CR-ET600 38T/44T	50	Double	CT-S510	
				SM-CRE61 38T/44T	46.5			
	HG 8-speed Single speed (1/2 inch x 1/8 inch)	SM-GEAR		CR-ET600 38T/44T	50	Single		
				SM-CRE61 38T/44T	46.5			
				CR-ET600 38T/44T	50	w/o		-
SM-CRE61 38T/44T	46.5							
NEXUS INTER-5E (Di2, Mechanical)	HG 9-speed CN-NX10	CS-C7000	FC-EM900 FC-M8150 FC-EM600 FC-EN500	CR-ET600 38T/44T	50	Double	CT-S510	
				CR-ET600 38T/44T	50	Single		
				SM-CRE61 38T/44T	46.5			
				CR-ET600 38T/44T	50	w/o		-
				SM-CRE61 38T/44T	46.5			

DU-E8000 / DU-E8080 / DU-E7000 C-656

12-speed Rear derailleur spec.

Shifting system	Chain type	Rear sprocket	Crank arm	Chainring	Chain line (mm)	Chain guard	Chain device
HYPERGLIDE+ 12-speed (Mechanical)	HG 12-speed	HYPERGLIDE+ 12-speed	FC-M8050 FC-E8050 FC-E8000	SM-CRE80-12-SB 34T/36T	56.5	-	CD-EM800
				CR-EM800*1 32T	55	-	CD-EM800 w/o plate
				SM-CRE80-12-B 34T/36T/38T			53
				SM-CRE70-12-B 36T	50	-	
				SM-CRE80-12-B 34T/36T/38T			50
				SM-CRE70-12-B 36T	50	-	
				SM-CRE80-R 47T			50
SM-CRE70-12 42T							

*1 Necessary to replace the lock ring to Y7K79801T.

11/10/9-speed Rear derailleur spec.

Shifting system	Chain type	Rear sprocket	Crank arm	Chainring	Chain line (mm)	Chain guard	Chain device
LINKGLIDE (Mechanical)	LINKGLIDE	LINKGLIDE	FC-M8050 FC-E8050 FC-E8000	SM-CRE80-B 34T/38T	55	-	CD-EM800 (Chain line: 55 mm)
				SM-CRE70-B 34T			
				SM-CRE80-B 34T/38T	53	-	CD-EM800 SM-CDE80 SM-CDE70
				SM-CRE70-B 34T			
				CR-ET600 38T/44T	50	Double	-
				SM-CRE80 34T/38T			
				SM-CRE80 44T			
				SM-CRE80-R 47T			
				SM-CRE70 38T			
SM-CRE70 38T							
HG 11-speed (Di2, Mechanical)	LINKGLIDE HG 11-speed	HG 11-speed	FC-M8050 FC-E8050 FC-E8000	SM-CRE80-B 34T/38T	55	-	CD-EM800 (Chain line: 55 mm)
				SM-CRE70-B 34T			
				SM-CRE80-B 34T/38T	53	-	CD-EM800 SM-CDE80 SM-CDE70
				SM-CRE70-B 34T			
				CR-ET600 38T/44T	50	Double	-
				SM-CRE80 34T/38T			
				SM-CRE80 44T			
				SM-CRE80-R 47T			
				SM-CRE70 38T			
SM-CRE70 38T							
HG 10-speed (Mechanical)	HG 10-speed	HG 10-speed	FC-M8050 FC-E8050 FC-E8000	SM-CRE80-B 34T/38T	55	-	CD-EM800 (Chain line: 55 mm)
				SM-CRE70-B 34T			
				SM-CRE80-B 34T/38T	53	-	CD-EM800 SM-CDE80 SM-CDE70
				SM-CRE70-B 34T			
				CR-ET600 38T/44T	50	Double	-
				SM-CRE80 34T/38T			
				SM-CRE80 44T			
				SM-CRE80-R 47T			
				SM-CRE70 38T			
SM-CRE70 38T							
HG 9-speed (Mechanical)	HG 9-speed	HG 9-speed	FC-M8050 FC-E8050 FC-E8000	SM-CRE70-B 34T	55	-	CD-EM800 (Chain line: 55 mm)
				SM-CRE70-B 34T	53		CD-EM800 SM-CDE80 SM-CDE70
				CR-ET600 38T/44T	50	Double	-
				SM-CRE80-R 47T	50	-	
				SM-CRE70 38T	50	-	SM-CDE80 w/o plate
				SM-CRE70 38T	50	Double	-

DU-E6100 / DU-E6100-CRG / DU-E6110 / DU-E6180 C-657

12-speed Rear derailleur spec.

Shifting system	Chain type	Rear sprocket	Crank arm	Chainring	Chain line (mm)	Chain guard	Chain device
HYPERGLIDE+ 12-speed (Mechanical)	HG 12-speed	HYPERGLIDE+ 12-speed	FC-M8050 FC-E8050 FC-E8000 FC-E6100	SM-CRE80-12-SB 34T/36T	56.5	-	-
				SM-CRE80-12-B 34T/36T/38T	55	-	
				SM-CRE70-12-B 36T			
				SM-CRE80-12-B 34T/36T/38T	53	-	
				SM-CRE70-12-B 36T			
				SM-CRE80-R 47T	50	-	
				SM-CRE70-12 42T		Double	

11/10/9-speed Rear derailleur spec.

Shifting system	Chain type	Rear sprocket	Crank arm	Chainring	Chain line (mm)	Chain guard	Chain device
LINKGLIDE (Mechanical)	LINKGLIDE	LINKGLIDE	FC-M8050 FC-E8050 FC-E8000 FC-E6100	SM-CRE80-B 34T/38T	55	-	-
				SM-CRE70-B 34T			
				SM-CRE80-B 34T/38T	53	-	
				SM-CRE70-B 34T			
				CR-ET600 38T/44T	50	Double	
				SM-CRE80 34T/38T		-	
				SM-CRE80 44T		Double	
				SM-CRE80-R 47T		-	
				SM-CRE70 38T		-	
				SM-CRE70 38T		Double	
				SM-CRE61 38T/44T		46.5	
HG 11-speed (Di2, Mechanical)	LINKGLIDE HG 11-speed	HG 11-speed	FC-M8050 FC-E8050 FC-E8000 FC-E6100	SM-CRE80-B 34T/38T	55	-	-
				SM-CRE70-B 34T			
				SM-CRE80-B 34T/38T	53	-	
				SM-CRE70-B 34T			
				CR-ET600 38T/44T	50	Double	
				SM-CRE80 34T/38T		-	
				SM-CRE80 44T		Double	
				SM-CRE80-R 47T		-	
				SM-CRE70 38T		-	
				SM-CRE70 38T		Double	
				SM-CRE61 38T/44T		46.5	

Shifting system	Chain type	Rear sprocket	Crank arm	Chainring	Chain line (mm)	Chain guard	Chain device
HG 10-speed (Mechanical)	LINKGLIDE HG 10-speed	HG 10-speed	FC-M8050 FC-E8050 FC-E8000 FC-E6100	SM-CRE80-B 34T/38T	55	-	-
				SM-CRE70-B 34T			
				SM-CRE80-B 34T/38T	53	-	
				SM-CRE70-B 34T			
				CR-ET600 38T/44T	50	Double	
				SM-CRE80 34T/38T		-	
				SM-CRE80 44T		Double	
				SM-CRE80-R 47T		-	
				SM-CRE70 38T		-	
				SM-CRE70 38T		Double	
				SM-CRE61 38T/44T		46.5	
				HG 9-speed (Mechanical)	LINKGLIDE HG 9-speed	HG 9-speed	
SM-CRE70-B 34T							
SM-CRE80-B 34T/38T	53	-					
SM-CRE70-B 34T							
CR-ET600 38T/44T	50	Double					
SM-CRE80 34T/38T		-					
SM-CRE80 44T		Double					
SM-CRE80-R 47T		-					
SM-CRE70 38T		-					
SM-CRE70 38T		Double					
SM-CRE61 38T/44T		46.5	Double, Single, w/o				

Internal geared hub spec.

Shifting system	Chain type	Rear sprocket	Crank arm	Chainring	Chain line (mm)	Chain guard	Chain tensioner	
ALFINE INTER-11/8 (Di2, Mechanical)	HG 10/9-speed	CS-S500	FC-M8050 FC-E8050 FC-E8000 FC-E6100	CR-ET600 38T/44T	50	Double	CT-S510	
				SM-CRE61 38T/44T	46.5			
	HG 8-speed	SM-GEAR		CR-ET600 38T/44T	50	Single		
				SM-CRE61 38T/44T	46.5			
				CR-ET600 38T/44T	50	w/o	-	
SM-CRE61 38T/44T	46.5							
NEXUS INTER-8 (Di2, Mechanical)	HG 10/9-speed	CS-S500	FC-M8050 FC-E8050 FC-E8000 FC-E6100	CR-ET600 38T/44T	50	Double	CT-S510	
				SM-CRE61 38T/44T	46.5			
	HG 8-speed Single speed 1/2 inch x 1/8 inch	SM-GEAR		CR-ET600 38T/44T	50	Single		
				SM-CRE61 38T/44T	46.5			
				CR-ET600 38T/44T	50	w/o	-	
SM-CRE61 38T/44T	46.5							
NEXUS INTER-7/3 (Mechanical)	HG 10/9-speed	CS-S500	FC-M8050 FC-E8050 FC-E8000 FC-E6100	CR-ET600 38T/44T	50	Double	CT-S510	
				SM-CRE61 38T/44T	46.5			
	HG 8-speed Single speed 1/2 inch x 1/8 inch	SM-GEAR		CR-ET600 38T/44T	50	Single		
				SM-CRE61 38T/44T	46.5			
				CR-ET600 38T/44T	50	w/o	-	
SM-CRE61 38T/44T	46.5							
NEXUS INTER-5E (Di2, Mechanical)	HG 9-speed CN-NX10	CS-C7000	FC-M8050 FC-E8050 FC-E8000 FC-E6100	CR-ET600 38T/44T	50	Double	CT-S510	
				CR-ET600 38T/44T	50	Single		
				SM-CRE61 38T/44T	46.5		w/o	-
				CR-ET600 38T/44T	50			
				SM-CRE61 38T/44T	46.5			

DU-E6000 / DU-E6001 / DU-E6010 / DU-E6050 C-658

11/10/9-speed Rear derailleur spec.

Shifting system	Chain type	Rear sprocket	Crank arm	Chainring	Chain line (mm)	Chain guard	Chain tensioner
HG 11-speed (Mechanical)	HG 11-speed	HG 11-speed	FC-E6000 FC-E6010 FC-E5000 FC-E5010	SM-CRE60 38T/44T	46.5	Double	-
HG 10-speed (Mechanical)	HG 10-speed	HG 10-speed		SM-CRE60 38T/44T	46.5	Double	-
HG 9-speed (Mechanical)	HG 9-speed	HG 9-speed		SM-CRE60 38T/44T	46.5	Double	-

Internal geared hub spec.

Shifting system	Chain type	Rear sprocket	Crank arm	Chainring	Chain line (mm)	Chain guard	Chain tensioner
ALFINE INTER-11/8 (Di2, Mechanical)	HG 9/8-speed	CS-S500	FC-E6000 FC-E6010 FC-E5000 FC-E5010	SM-CRE60 38T/44T	46.5	w/o	CT-S510
		SM-GEAR			46.5	Double	
NEXUS INTER-8 (Di2, Mechanical)	HG Single speed (1/2 inch x 1/8 inch)	SM-GEAR		SM-CRE60 38T/44T	46.5	Single, w/o	CT-S510 *
NEXUS INTER-7/3 (Mechanical)	HG Single speed (1/2 inch x 1/8 inch)	SM-GEAR		SM-CRE60 38T/44T	46.5	Single, w/o	
NEXUS INTER-5E (Di2, Mechanical)	HG 8/7/6-speed	CS-C7000		SM-CRE60 38T/44T	46.5	Double	-

* Not compatible with CN-NX10

DU-E5100 / DU-E5000 / DU-E5080 / DU-E5080-H C-659

11/10/9-speed Rear derailleur spec.

Shifting system	Chain type	Rear sprocket	Crank arm	Chainring	Chain line (mm)	Chain guard	Chain device
LINKGLIDE (Mechanical)	LINKGLIDE	LINKGLIDE	FC-E6000 FC-E6010 FC-E5000 FC-E5010	SM-CRE50 38T/44T	46.5	Double, Single, w/o	-
HG 11-speed (Di2, Mechanical)	HG 11-speed	HG 11-speed		SM-CRE50 38T/44T	46.5	Double, Single, w/o	
HG 10-speed (Mechanical)	HG 10-speed	HG 10-speed		SM-CRE50 38T/44T	46.5	Double, Single, w/o	
HG 9-speed (Mechanical)	HG 9-speed	HG 9-speed		SM-CRE50 38T/44T	46.5	Double, Single, w/o	

Internal geared hub spec.

Shifting system	Chain type	Rear sprocket	Crank arm	Chainring	Chain line (mm)	Chain guard	Chain device
ALFINE INTER-11/8 (Di2, Mechanical)	HG 10/9-speed	CS-S500	FC-E6000 FC-E6010 FC-E5000 FC-E5010	SM-CRE50 38T/44T	46.5	Double	CT-S510
	HG 8-speed	SM-GEAR		SM-CRE50 38T/44T		Single	
				SM-CRE50 38T/44T		w/o	
NEXUS INTER-8 (Di2, Mechanical)	HG 10/9-speed	CS-S500		SM-CRE50 38T/44T	46.5	Double	CT-S510
	HG 8-speed Single speed (1/2 inch x 1/8 inch)	SM-GEAR		SM-CRE50 38T/44T		Single	
				SM-CRE50 38T/44T		w/o	
NEXUS INTER-7/3 (Mechanical)	HG 10/9-speed	CS-S500		SM-CRE50 38T/44T	46.5	Double	CT-S510
	HG Single speed (1/2 inch x 1/8 inch)	SM-GEAR		SM-CRE50 38T/44T		Single	
				SM-CRE50 38T/44T		w/o	
NEXUS INTER-5E (Di2, Mechanical)	HG 8-speed CN-NX10	CS-C7000	SM-CRE50 38T/44T	46.5	Single, w/o	-	

For Hydraulic Disc brake

For MTB Di2 shift switch, refer to [C-744](#)

I-SPEC EV type brake lever

Model No.	SHIMANO E-BIKE SYSTEMS cycle computer		
	SC-EN500 *1	SC-E5000 *1	SC-E5003 *1
BL-M9100	✓	✓	-
BL-M9120	✓	✓	-
BL-M8100	✓	✓	-
BL-M7100	✓	✓	-
BL-M6100	✓	✓	-
BL-M4100	✓	✓	-

Model No.	SHIMANO E-BIKE SYSTEMS switch unit						
	SW-EM800-L	SW-EN600-L	SW-EN600-R	SW-E8000-L	SW-E7000	SW-E6010	SW-E6000
BL-M9100	✓	✓	✓	-	✓	✓	✓
BL-M9120	✓	✓	✓	-	✓	✓	✓
BL-M8100	✓	✓	✓	-	✓	✓	✓
BL-M7100	✓	✓	✓	-	✓	✓	✓
BL-M6100	✓	✓	✓	-	✓	✓	✓
BL-M4100	✓	✓	✓	-	✓	✓	✓

*1 I-SPEC EV compatible spec only.

I-SPEC II type brake lever

Model No.	SHIMANO E-BIKE SYSTEMS cycle computer		
	SC-EN500	SC-E5000	SC-E5003
BL-M9000	✓	✓	✓
BL-M9020	✓	✓	✓
BL-M8000	✓	✓	✓
BL-T8100	✓	✓	✓
BL-T8000	✓	✓	✓
BL-M7000	✓	✓	✓
BL-M6000	✓	✓	✓
BL-T6000	✓	✓	✓
BL-RS600	✓	✓	✓
BL-MT501	✓	✓	✓
BL-U8000 *1	✓	✓	✓

Model No.	SHIMANO E-BIKE SYSTEMS switch unit						
	SW-EM800-L	SW-EN600-L	SW-EN600-R	SW-E8000-L	SW-E7000	SW-E6010	SW-E6000
BL-M9000	✓	✓	✓	✓	✓	✓	✓
BL-M9020	✓	✓	✓	✓	✓	✓	✓
BL-M8000	✓	✓	✓	✓	✓	✓	✓
BL-T8100	✓	✓	✓	✓	✓	✓	✓
BL-T8000	✓	✓	✓	✓	✓	✓	✓
BL-M7000	✓	✓	✓	✓	✓	✓	✓
BL-M6000	✓	✓	✓	✓	✓	✓	✓
BL-T6000	✓	✓	✓	✓	✓	✓	✓
BL-RS600	✓	✓	✓	✓	✓	✓	✓
BL-MT501	✓	✓	✓	✓	✓	✓	✓
BL-U8000 *1	✓	✓	✓	-	✓	✓	✓

*1 As for the compatibility between BL-U8000 and mechanical shifter, please refer to the [C-738](#).

Other clamp band type brake lever

Model No.	SHIMANO E-BIKE SYSTEMS cycle computer		
	SC-EN500	SC-E5000	SC-E5003
BL-MT402-3A	✓	✓	✓
BL-MT401	✓	✓	✓
BL-MT201	✓	✓	✓
BL-MT200	✓	✓	✓

Model No.	SHIMANO E-BIKE SYSTEMS switch unit						
	SW-EM800-L	SW-EN600-L	SW-EN600-R	SW-E8000-L	SW-E7000	SW-E6010	SW-E6000
BL-MT402-3A	✓	✓	✓	✓	✓	✓	✓
BL-MT401	✓	✓	✓	✓	✓	✓	✓
BL-MT201	✓	✓	✓	✓	✓	✓	✓
BL-MT200	✓	✓	✓	✓	✓	✓	✓

Brake lever for mechanical brake (Mechanical disc brake / V-BRAKE / Caliper brake / Cantilever brake)

Refer to Spec Hand Book for compatible brake type.

Model No.	SHIMANO E-BIKE SYSTEMS cycle computer		
	SC-EN500	SC-E5000	SC-E5003
BL-T610	✓	✓	✓
BL-T611	✓	✓	✓
BL-T4000	✓	✓	✓
BL-T4010	✓	✓	✓
BL-C6010	✓	✓	✓
BL-4700	✓	✓	✓
BL-R3000	✓	✓	✓
BL-R2000	✓	✓	✓
BL-R780	✓	✓	✓
BL-R550	✓	✓	✓

Model No.	SHIMANO E-BIKE SYSTEMS switch unit						
	SW-EM800-L	SW-EN600-L	SW-EN600-R	SW-E8000-L	SW-E7000	SW-E6010	SW-E6000
BL-T610	✓	✓	✓	✓	✓	✓	✓
BL-T611	✓	✓	✓	✓	✓	✓	✓
BL-T4000	✓	✓	✓	✓	✓	✓	✓
BL-T4010	✓	✓	✓	✓	✓	✓	✓
BL-C6010	✓	✓	✓	✓	✓	✓	✓
BL-4700	✓	✓	✓	✓	✓	✓	✓
BL-R3000	✓	✓	✓	✓	✓	✓	✓
BL-R2000	✓	✓	✓	✓	✓	✓	✓
BL-R780	✓	✓	✓	✓	✓	✓	✓
BL-R550	✓	✓	✓	✓	✓	✓	✓

Battery

Batteries shipped in the country / region are different.

For Gen.2 battery management system

Batteries with a suffix of '-A' at the end of the name are EN50604-1 certified.

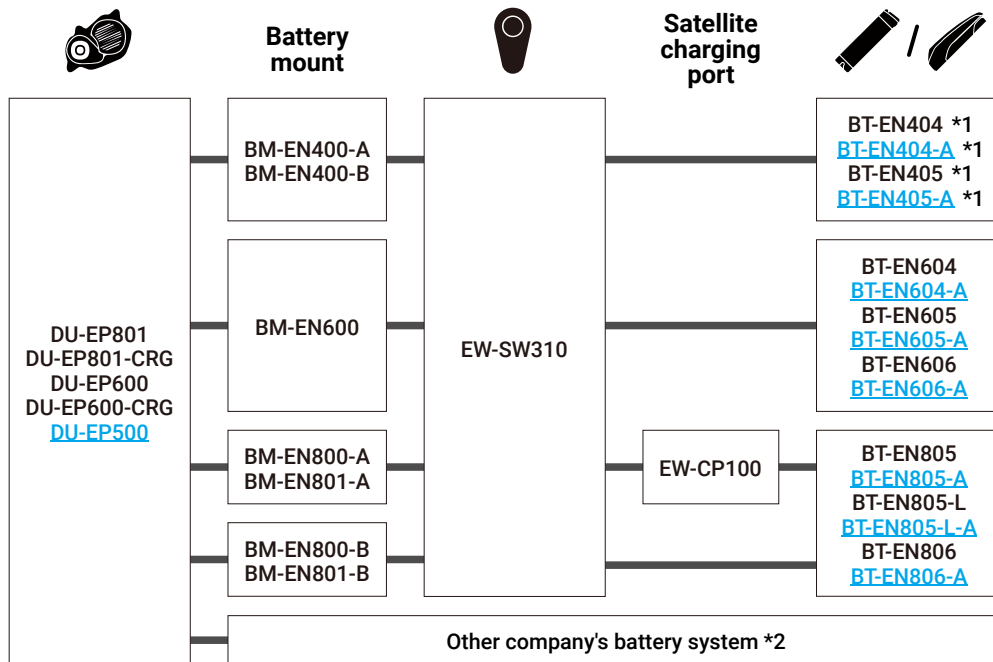

Limitation of function

*1 These batteries don't support over 500W drive unit power output

*2 Some of these batteries don't support over 500W drive unit power output

For 1st generation battery management system

Batteries with a suffix of '-A' at the end of the name are EN50604-1 certified.

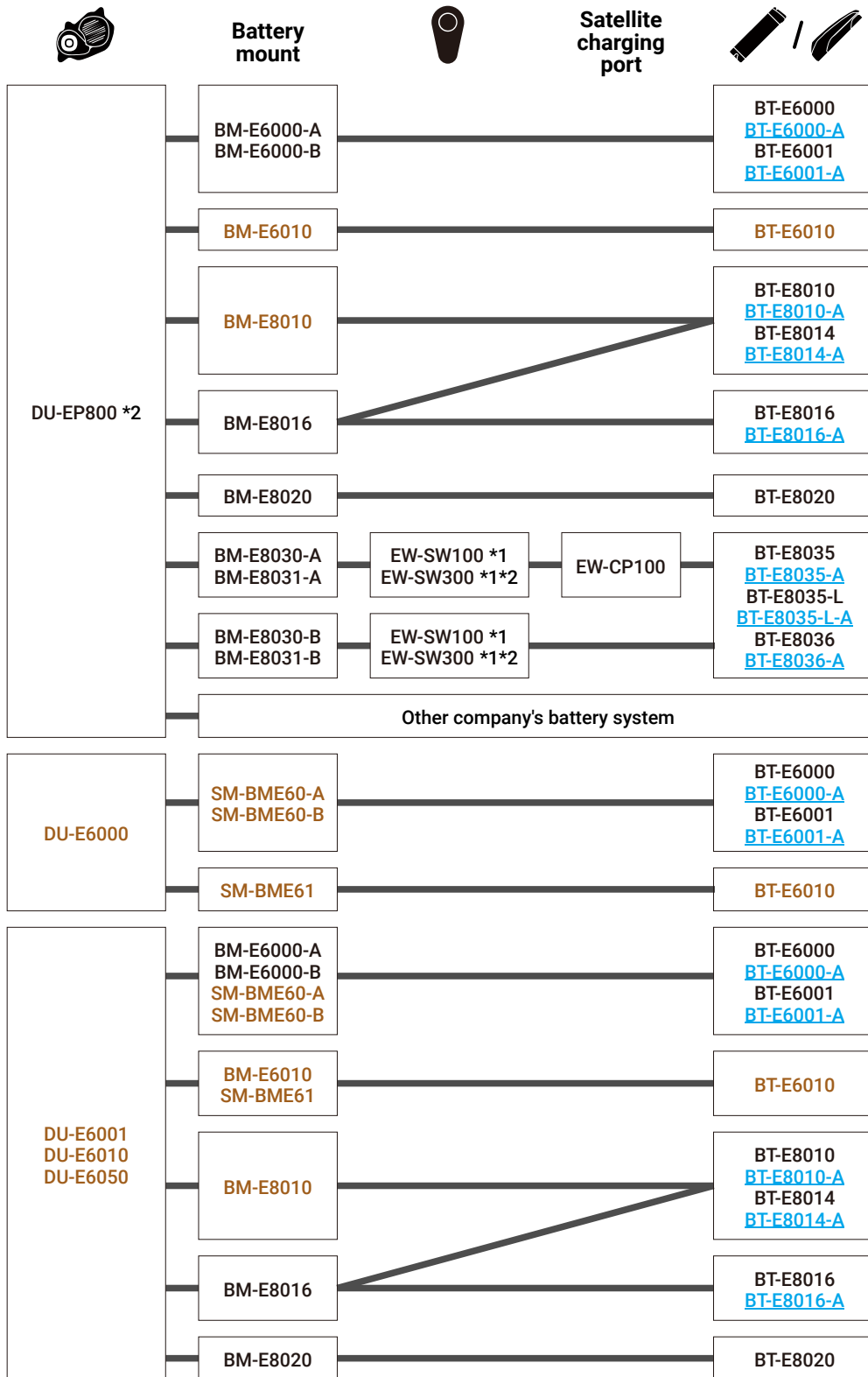

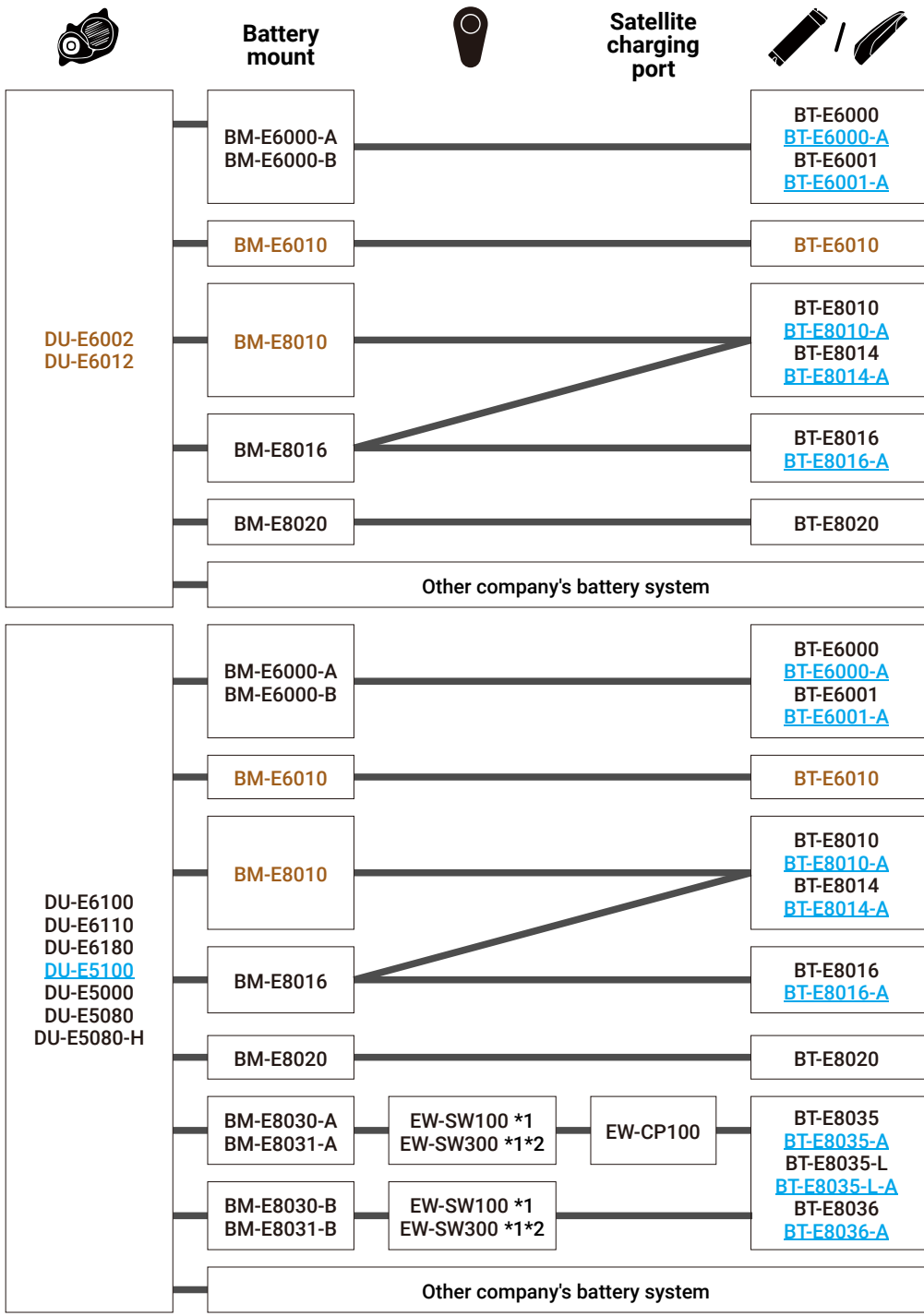

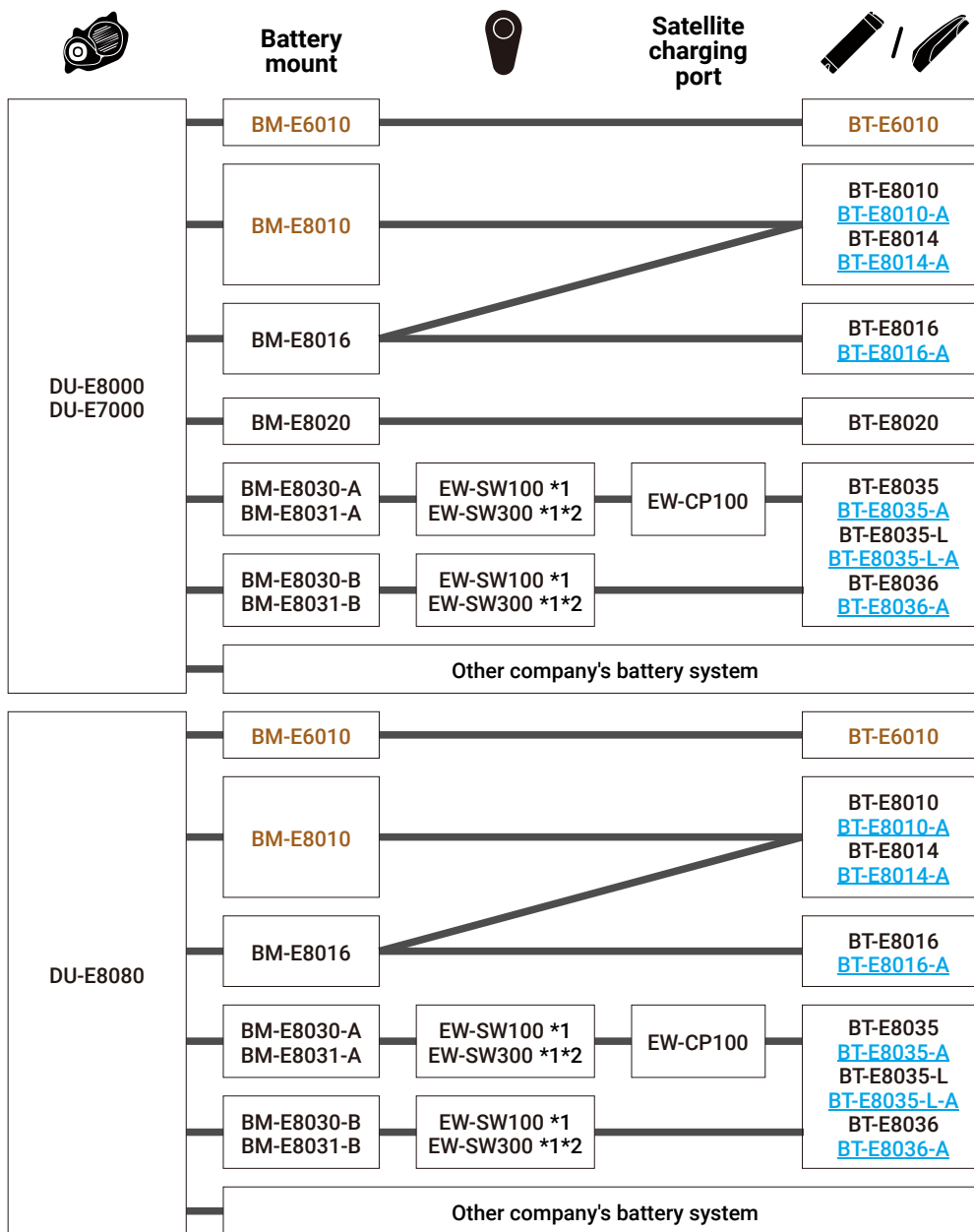

Limitation of function

*1 Can't use with SC-E6010

*2 This unit has SD300 port, and needs EW-AD305 for connection to SD50 port unit.

Frame mount compatibility

External battery type

Batteries with a suffix of '-A' at the end of the name are EN50604-1 certified.

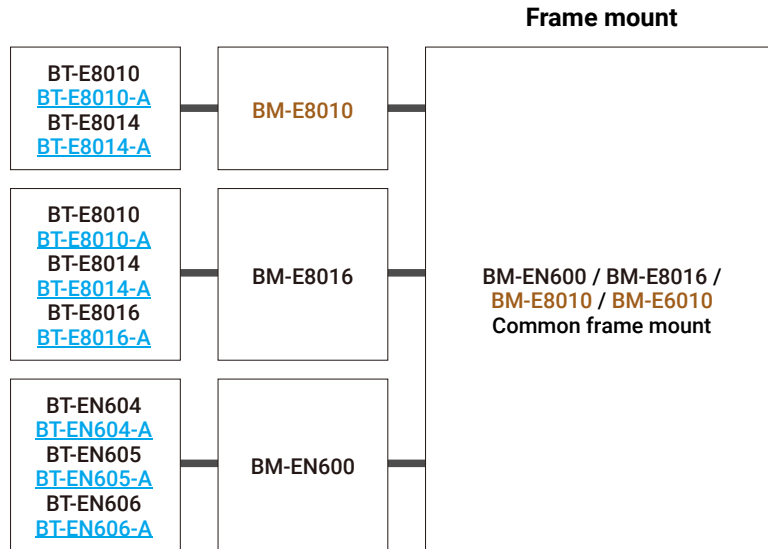

Integrated battery type

Batteries with a suffix of '-A' at the end of the name are EN50604-1 certified.

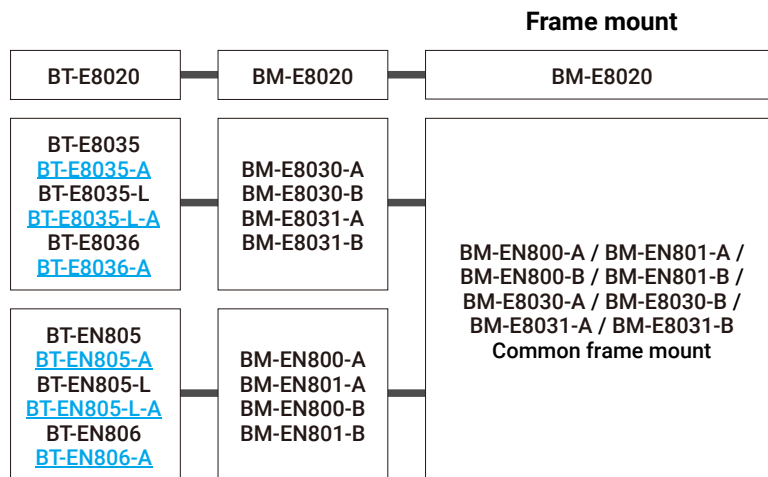

System on/off function compatibility

 : Products marked with this icon have the main power ON/OFF function of the E-BIKE.

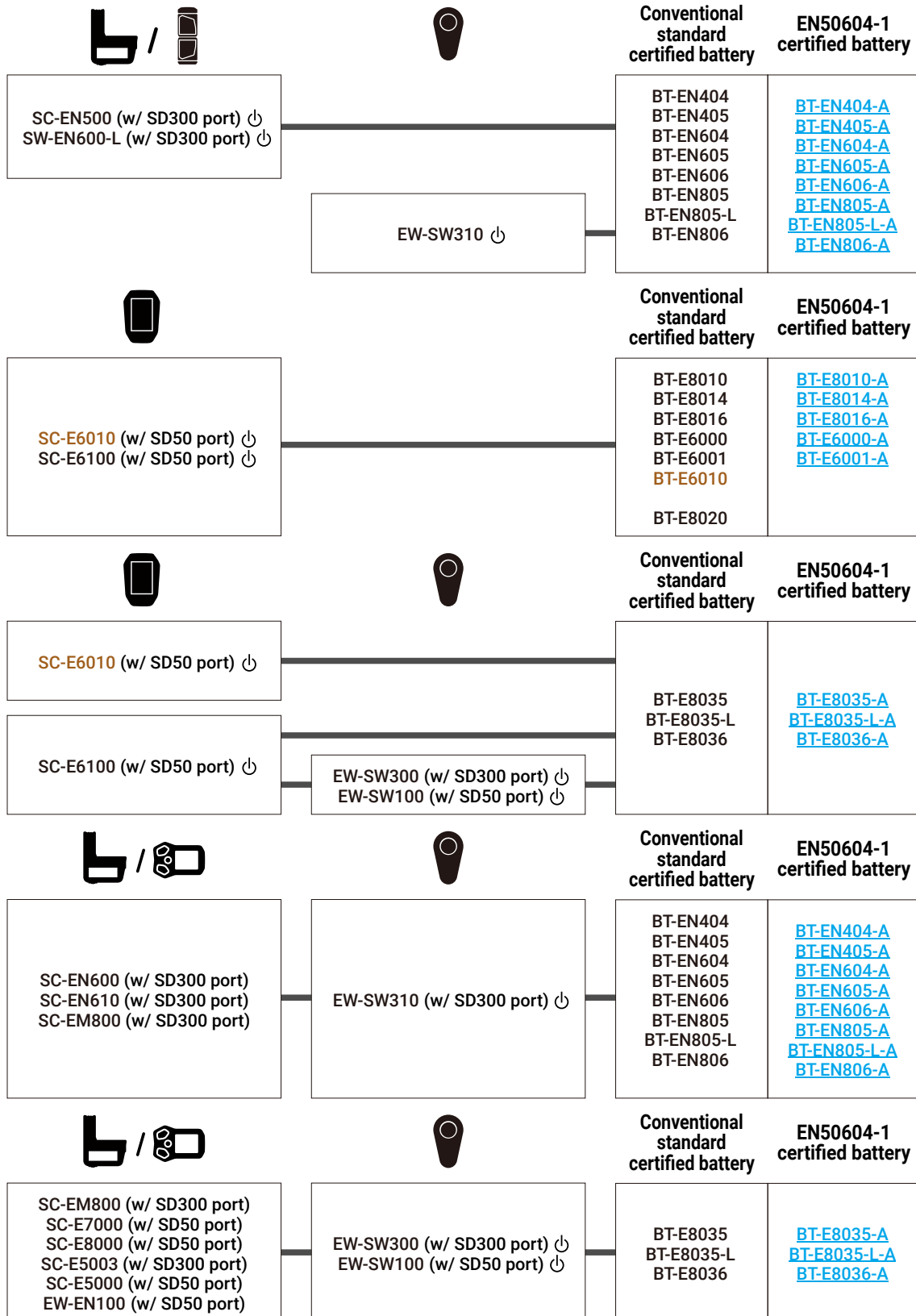

Configuration of assist switch functions

3 buttons (exclude system ON/OFF) in E-BIKE system are necessary to operate full of e-bike functions.
 If the system only have 1 or 2 buttons, functions to operate in the E-BIKE are limited as shown in the list.

Drive Unit	Cockpit item 1	Cockpit item 2	Cockpit item 3	Total number of switches in the E-BIKE	Configuration for switch function	Functions in customize menu
DU-EP801 DU-EP801-CRG DU-EP600 DU-EP600-CRG DU-EP500	SC-EN500	-	-	5	1: System ON/OFF 2: Assist up 3: Assist down 4: Display / Setting 5: Light ON/OFF	-
	SW-EN600-L	-	-	5	1: System ON/OFF 2: Assist up (**) 3: Assist down (**) 4: Display / Setting 5: - (**)	D-FLY Display / Setting Gear shifting mode Light ON/OFF
	SC-EN600 SC-EN610	SW-EN600-L	-	5	1: System ON/OFF 2: Assist up 3: Assist down 4: Display / Setting (**) 5: Light ON/OFF	D-FLY Display / Settings Gear shifting mode Light on/off
	SC-EN600 SC-EN610	EW-SW310	SW-EM800-L	4	1: System ON/OFF 2: Assist up (**) 3: Assist down (**) 4: Display / Setting (**) * Light can be turned ON/OFF via cycle computer setting menu	Assist up Assist down Rear shift up Rear shift down D-FLY Display / Setting Gear shifting mode Light ON/OFF RD function
	SC-EM800	EW-SW310	SW-EM800-L	5	1: System ON/OFF 2: Assist up (**) 3: Assist down (**) 4: Display / Setting 5: Light ON/OFF (**)	Assist up Assist down Rear shift up Rear shift down D-FLY Display / Setting Gear shifting mode Light ON/OFF RD function
	SC-EM800	SW-EM800-L	-	3	1: Assist up (**) 2: Assist down (**) 3: Display / Setting * Light can be turned ON/OFF via cycle computer setting menu * System can be turned ON/OFF via button on the battery	Assist up Assist down Rear shift up Rear shift down D-FLY Display / Setting Gear shifting mode Light ON/OFF RD function
	EW-SW310	-	-	2	1: System ON/OFF 2: Assist up (Cycle) (*, **)	D-FLY Display / Setting Gear shifting mode Light ON/OFF
	SC-EN600 SC-EN610	EW-SW310	-	2	1: System ON/OFF 2: Assist up (Cycle) (*, **)	D-FLY Display / Setting Gear shifting mode Light ON/OFF
	SC-EM800	EW-SW310	-	3	1: System ON/OFF 2: Assist up (Cycle) (*, **) 3: Display / Setting	D-FLY Display / Setting Gear shifting mode Light ON/OFF

* Each time you press the switch, the mode changes to a mode with stronger assist power, and returns to OFF from mode of maximum assist power.

Example: OFF→ECO→TRAIL→BOOST→OFF

** Function assignments to buttons can be customized.

Speed sensor

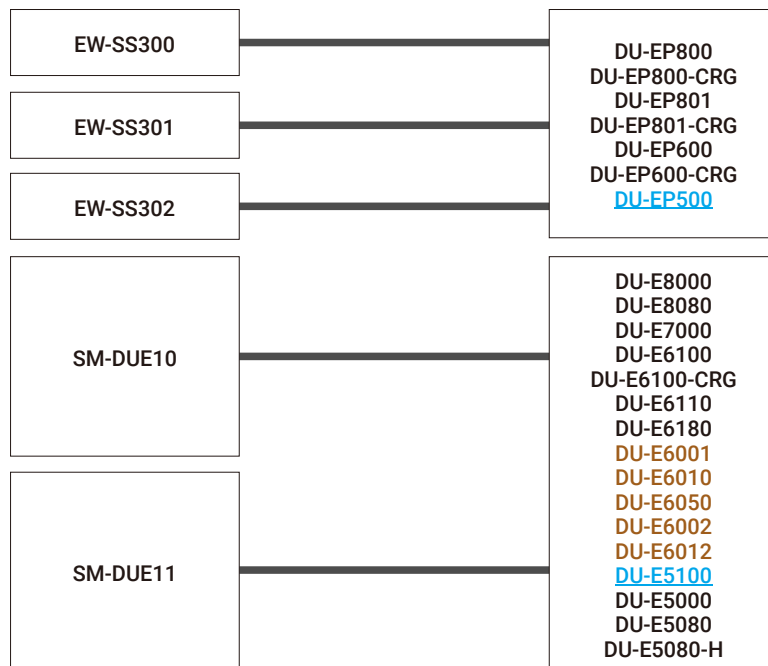

For EN50604-1 certified battery

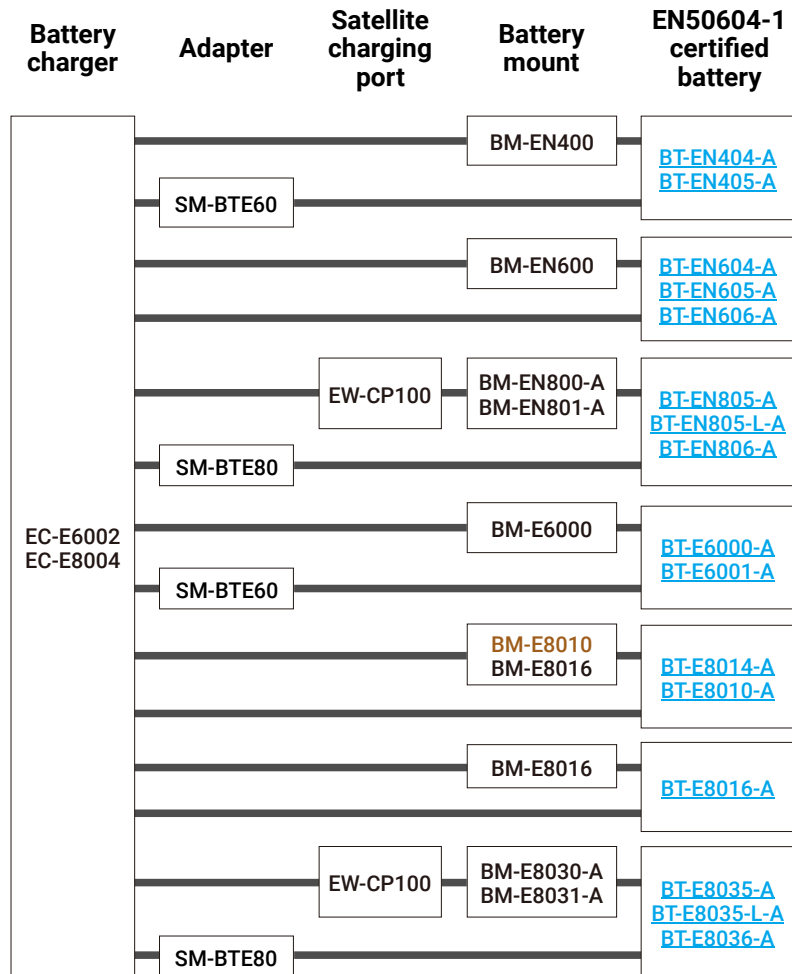

For conventional standard certified battery

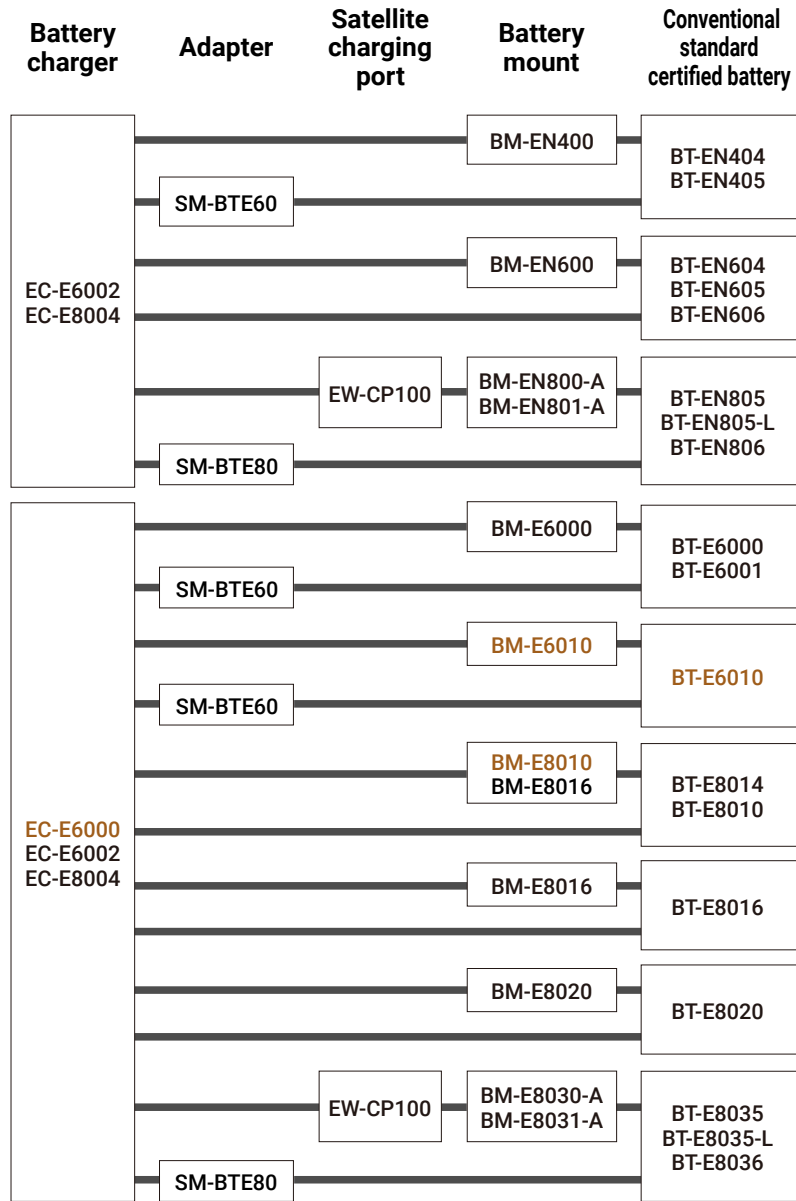

ABS main unit and drive unit compatibility

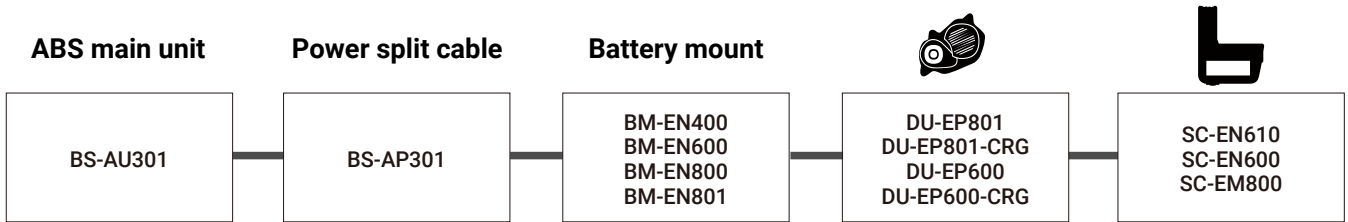

Wheel speed sensor and rotor compatibility

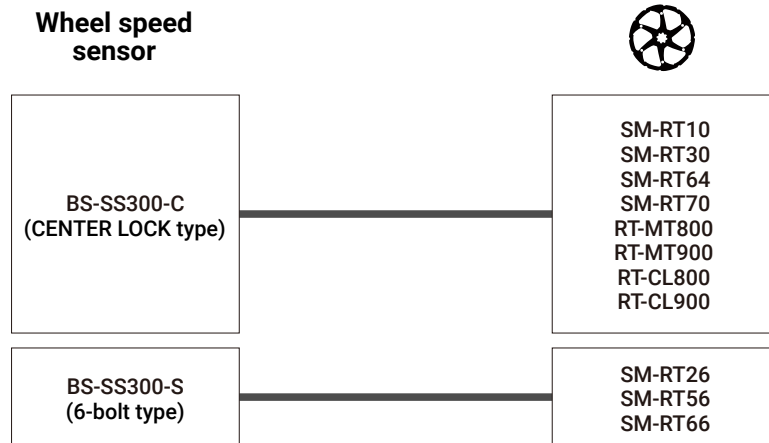

Compatibility chart of E-TUBE PROJECT Cyclist/Professional v5.3.2

Di2 with BT-DN300

C-473

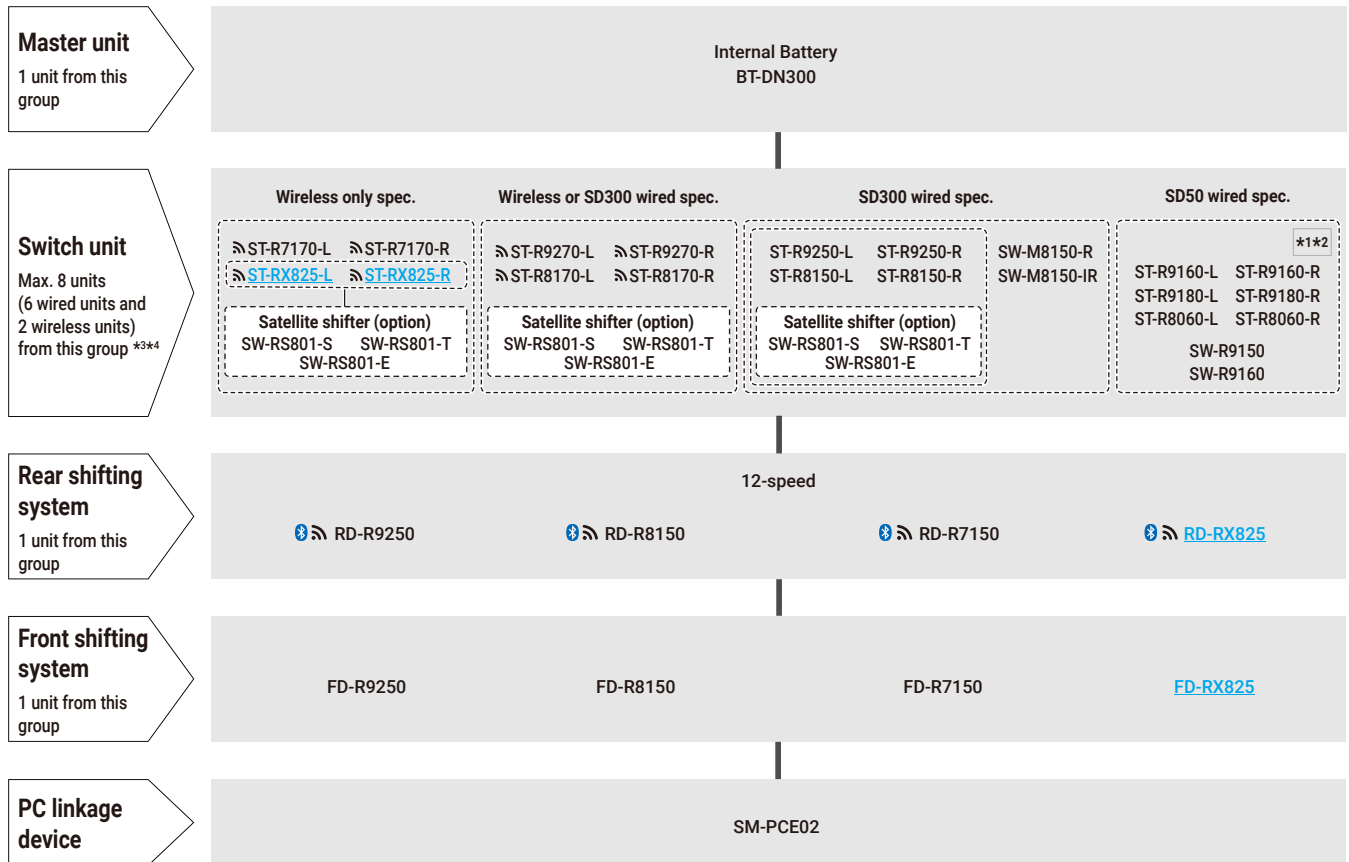

Limitation of function with BT-DN300

- *1 Wired connection to BT-DN300 only.
- *2 EW-AD305 is needed.
- *3 Wireless DUAL CONTROL LEVERs must be paired Right and Left (It's not allowed to choose two of right side units or 2 of left side units)
- *4 There is no limitation to connect switch unit for right side or left side unit in case of it's wired connection.

Di2 with BM-DN100 / BT-DN110

BT-DN110-A is displayed as BT-DN110 on E-TUBE PROJECT

Master unit
1 unit from this group

System information display or junction [A]
1 unit from this group

Switch unit
Max. 6 unit from this group

Rear shifting system
1 unit from this group

Front shifting system
1 unit from this group

Wireless unit
1 unit from this group

PC linkage device

Front fork suspension

Rear suspension

Suspension control switch

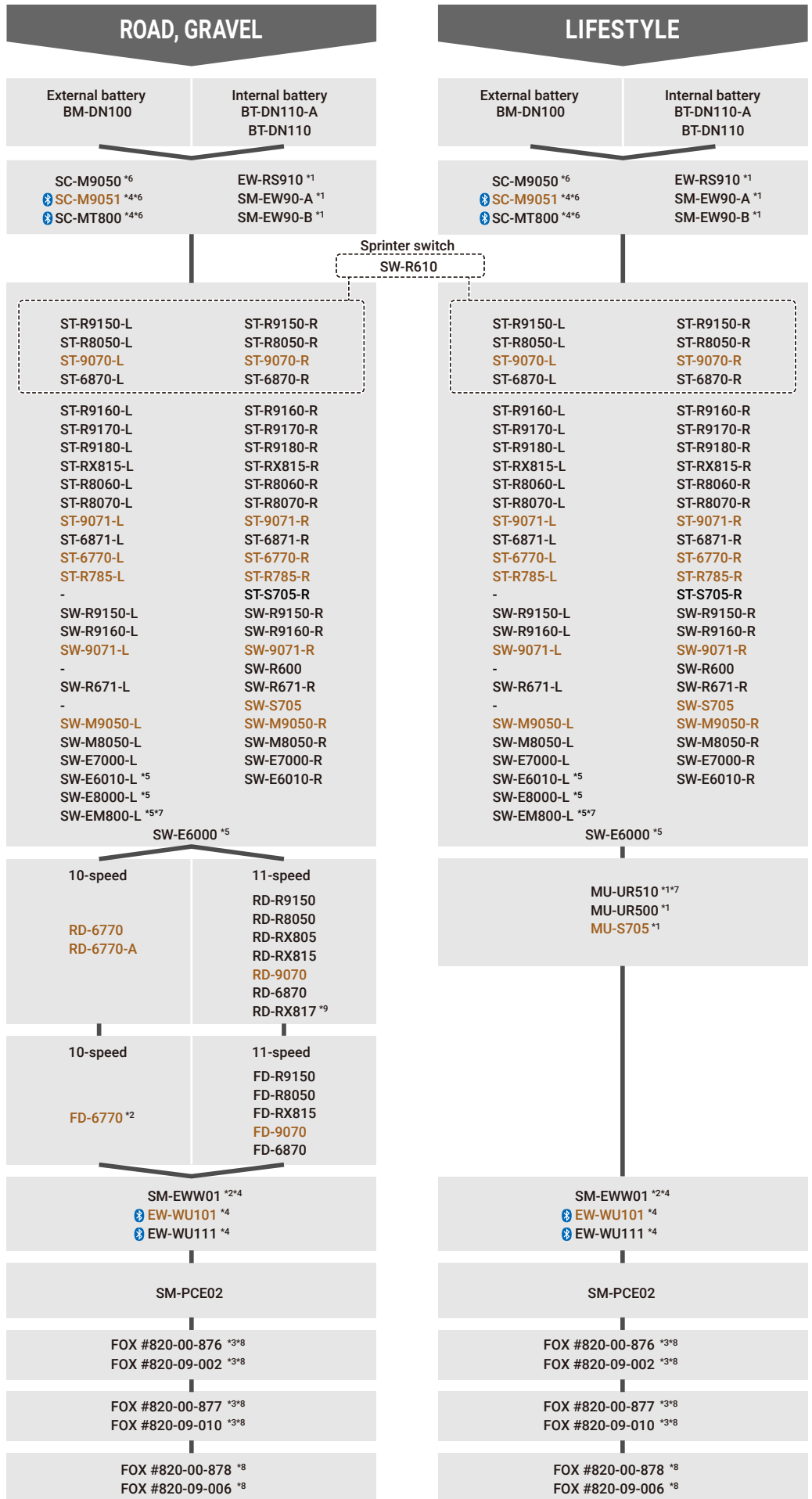

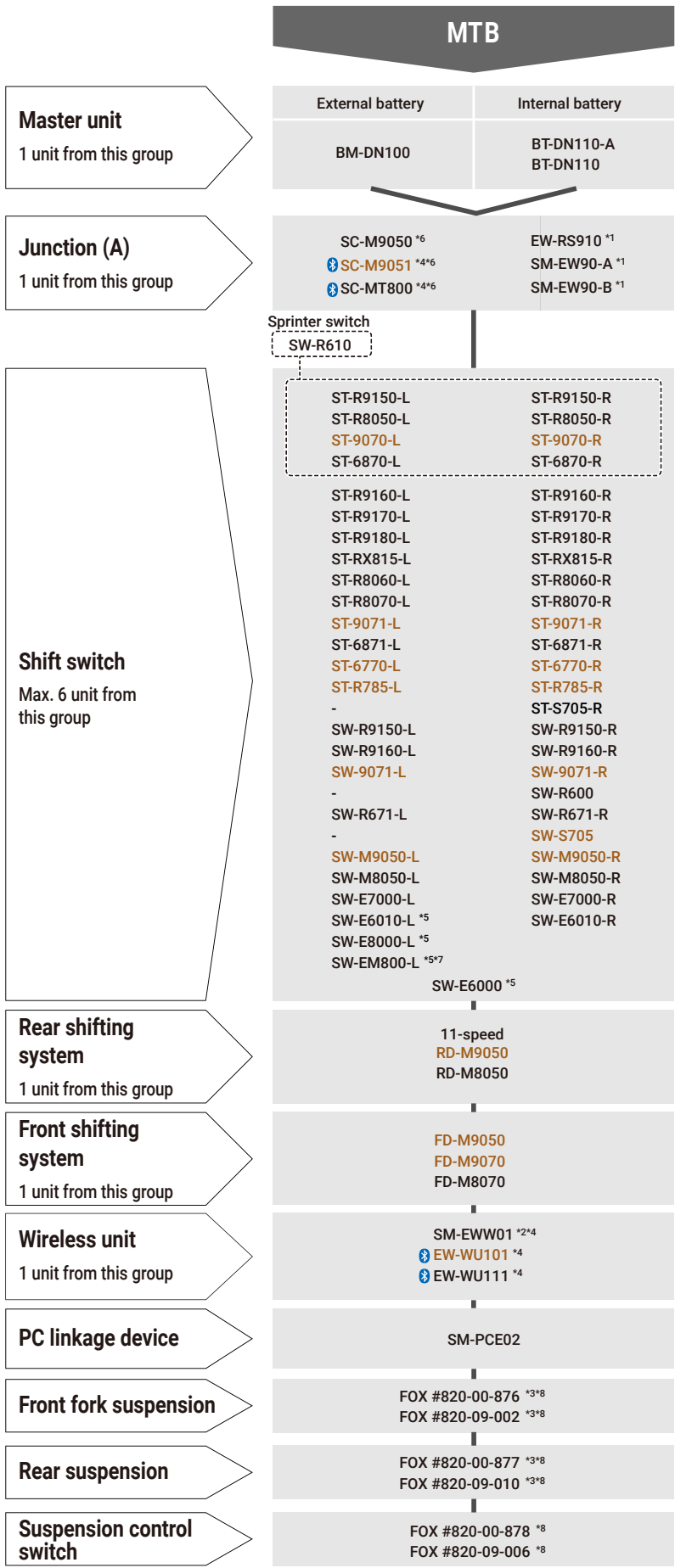

Limitation of function with BM-DN100 / BT-DN110

- *1 Shifting adjustment mode for MU-S705, MU-UR500 and MU-UR510 is not supported (need E-TUBE PROJECT to adjust)
- *2 Not supported by E-TUBE PROJECT Cyclist
- *3 A designated control switch and/or the combination SW-M9050/SW-M8050-L with SC-M9050/SC-M9051/SC-MT800 is required to operate
- *4 The system accepts just 1 unit with wireless chip (doesn't work if plural units with wireless chip are connected)
- *5 Need to change switch setting by E-TUBE PROJECT
- *6 SC-M9050, SC-M9051 or SC-MT800 is required for SYNCHRONIZED SHIFT in MTB category
- *7 This unit has SD300 port, and needs EW-AD305 for connection with SD50 port unit
- *8 Only supported by E-TUBE PROJECT Cyclist
- *9 For front single models only. Cannot be used in combination with a front derailleur.

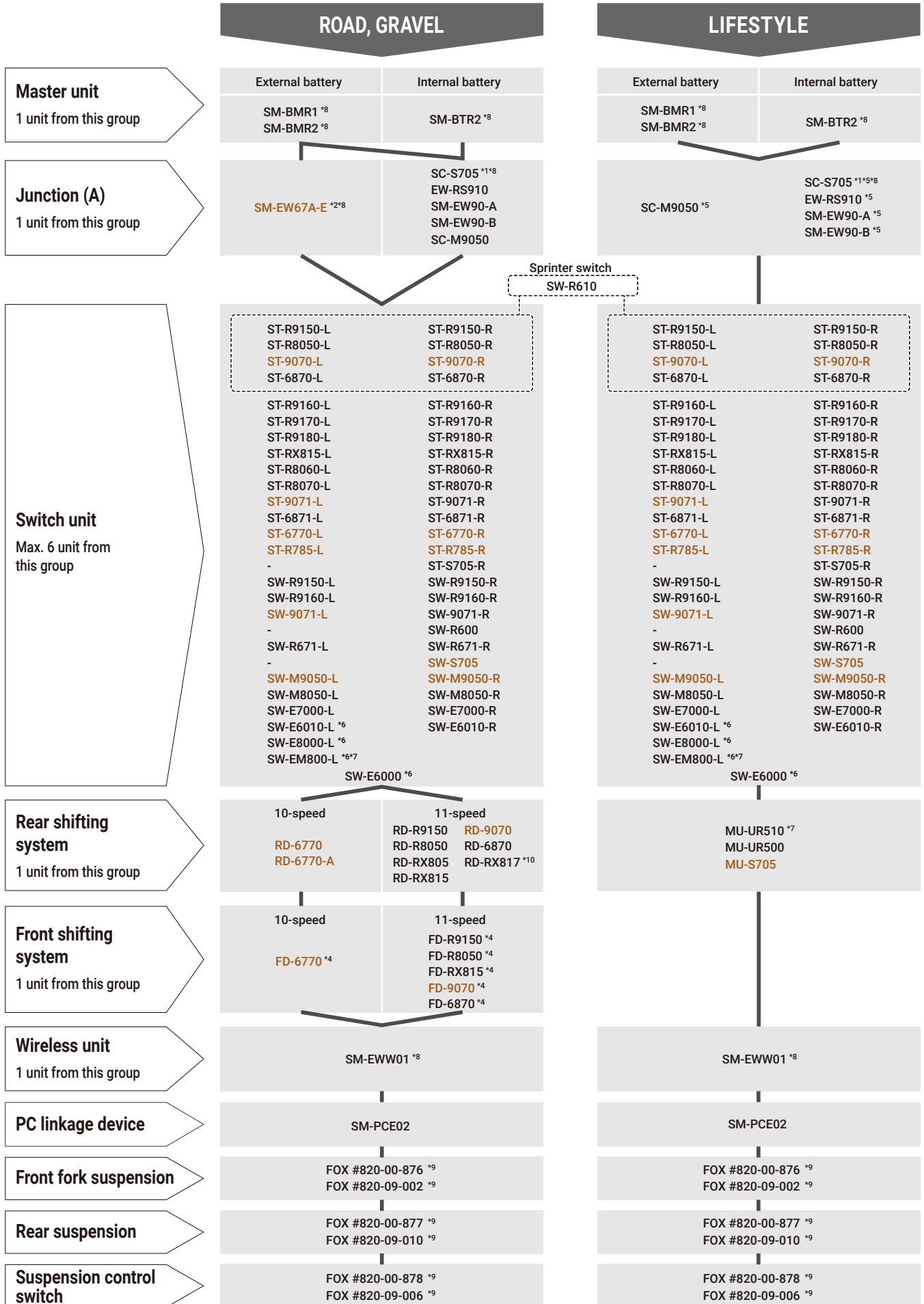

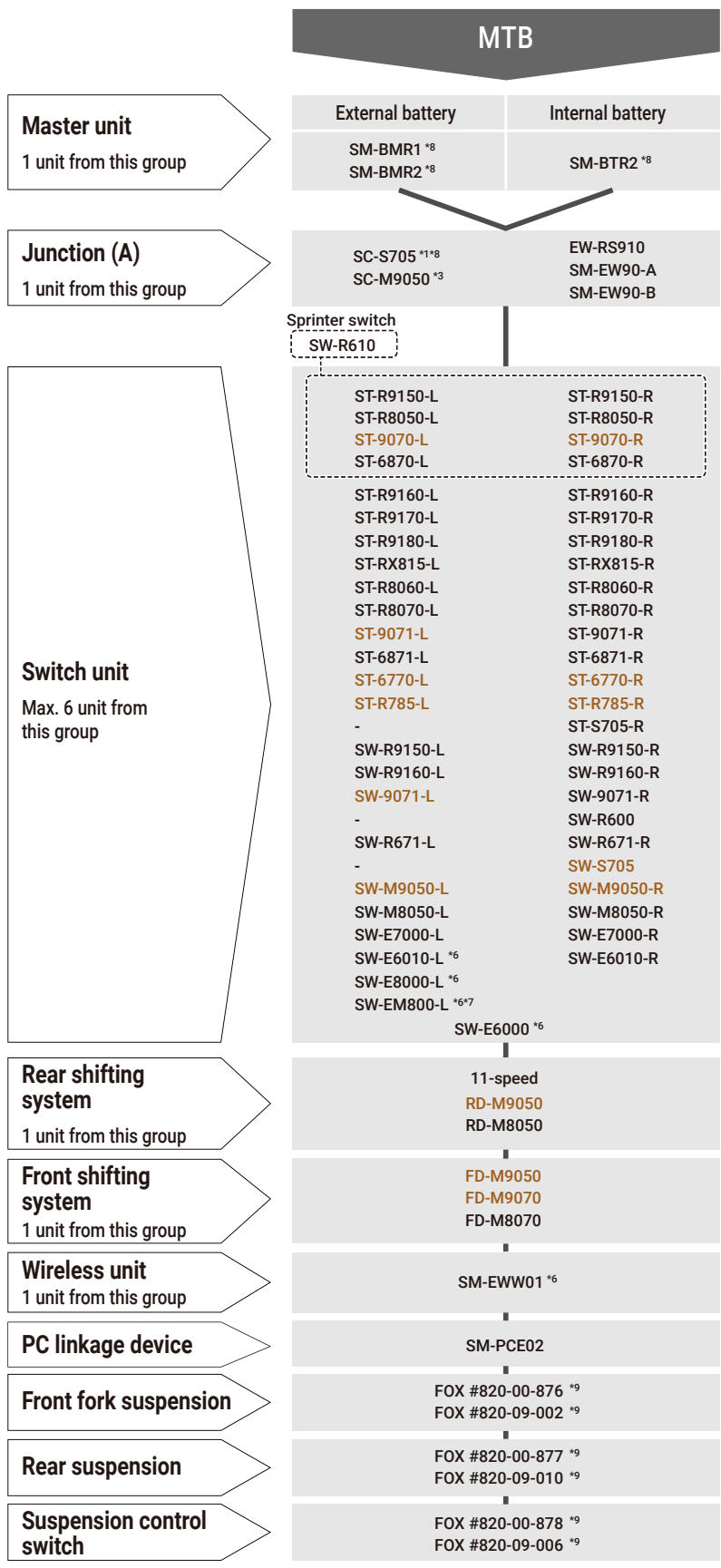

Limitation of function with SM-BMR1 / SM-BMR2 / SM-BTR2

*1 SC-S705

- Front derailleur position will not appear on display.
- Recovery from Rear derailleur protection function is not available.
- Front / Rear derailleur adjustment mode is not available. Use E-TUBE PROJECT software.
- SC-S705 has only 1 SD50 port for ST / SW.
- SC-S705 may not turn on the display by front shift switch.

*2 SM-BCR2 requires any device which has charging port.

SM-EW67-A-E (Junction [A]) is not compatible with SM-BCR2 and SM-BTR2.

*3 SC-M9050 is required for SYNCHRONIZED SHIFT in case with MTB-type Rear Derailleur

*4 SYNCHRONIZED SHIFT is not available with Road-type Rear Derailleur

*5 Shifting adjustment mode for MU-S705 , MU-UR500 and MU-UR510 is not supported (need E-TUBE PROJECT to adjust)

*6 Need to change switch setting by E-TUBE PROJECT

*7 This unit has SD300 port, and needs EW-AD305 for connection with SD50 port unit

*8 Not supported by E-TUBE PROJECT Cyclist

*9 Only supported by E-TUBE PROJECT Cyclist

*10 For front single models only. Cannot be used in combination with a front derailleur.

Compatibility chart of E-TUBE PROJECT Cyclist/Professional v5.3.2

Di2 with [EW-PS300](#)

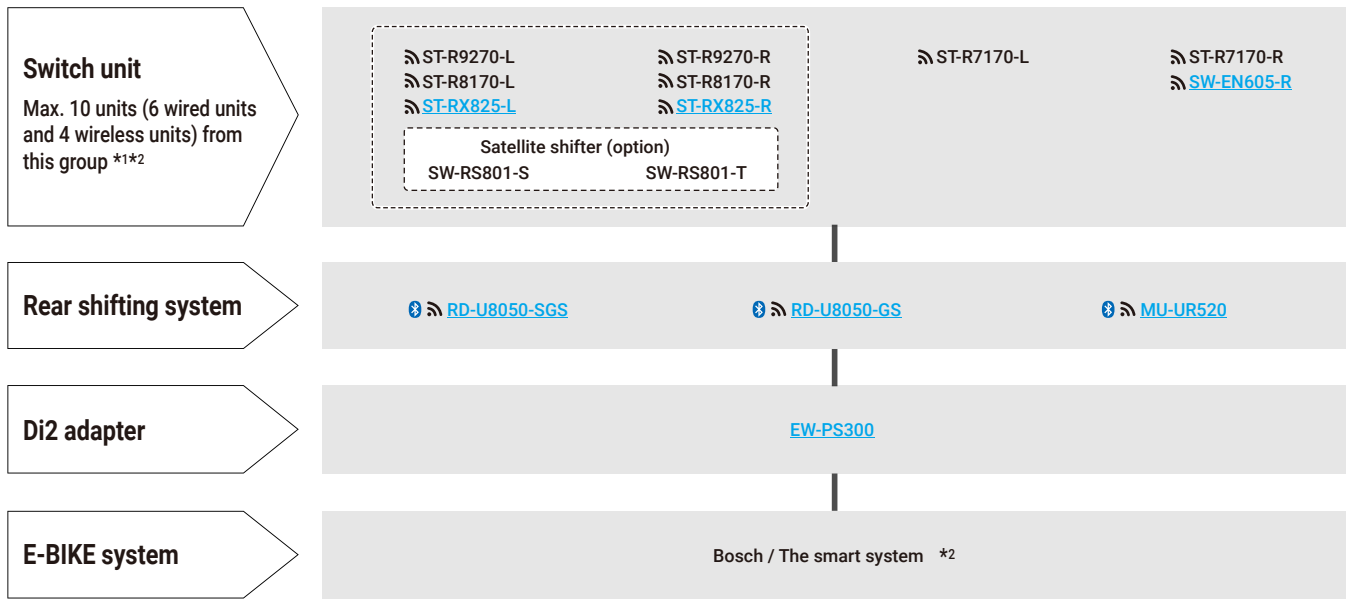

Limitation of function

*1 Wireless DUAL CONTROL LEVERs must be paired Right and Left (It's not allowed to choose two of right side units or 2 of left side units)

*2 There is no limitation to connect switch unit for right side or left side unit in case of it's wired connection.

Di2 with EW-EX310

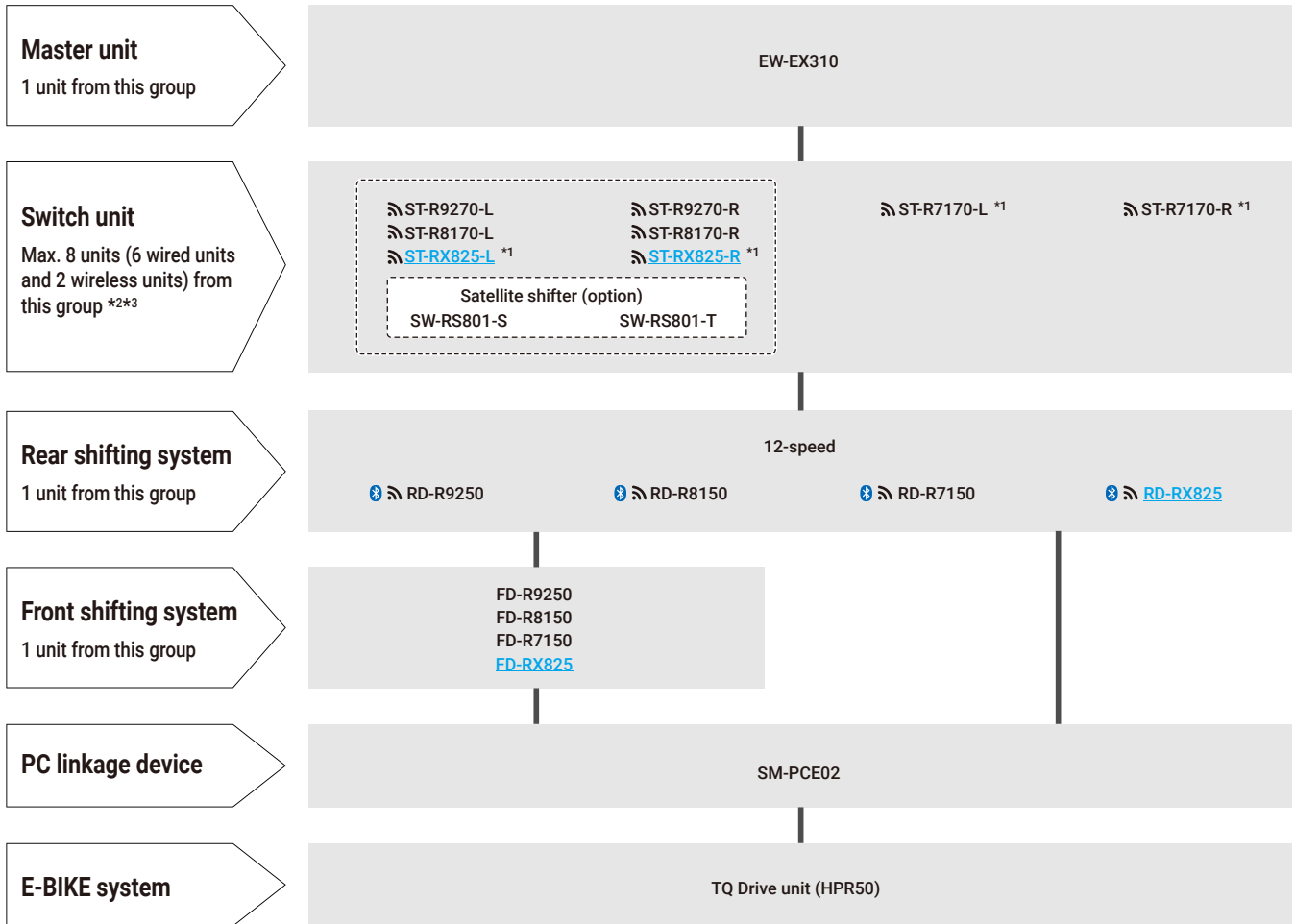

Limitation of function

*1 Wireless connection only

*2 Wireless DUAL CONTROL LEVERs must be paired Right and Left (It's not allowed to choose two of right side units or 2 of left side units)

*3 There is no limitation to connect switch unit for right side or left side unit in case of it's wired connection.

Di2 with EW-EX010

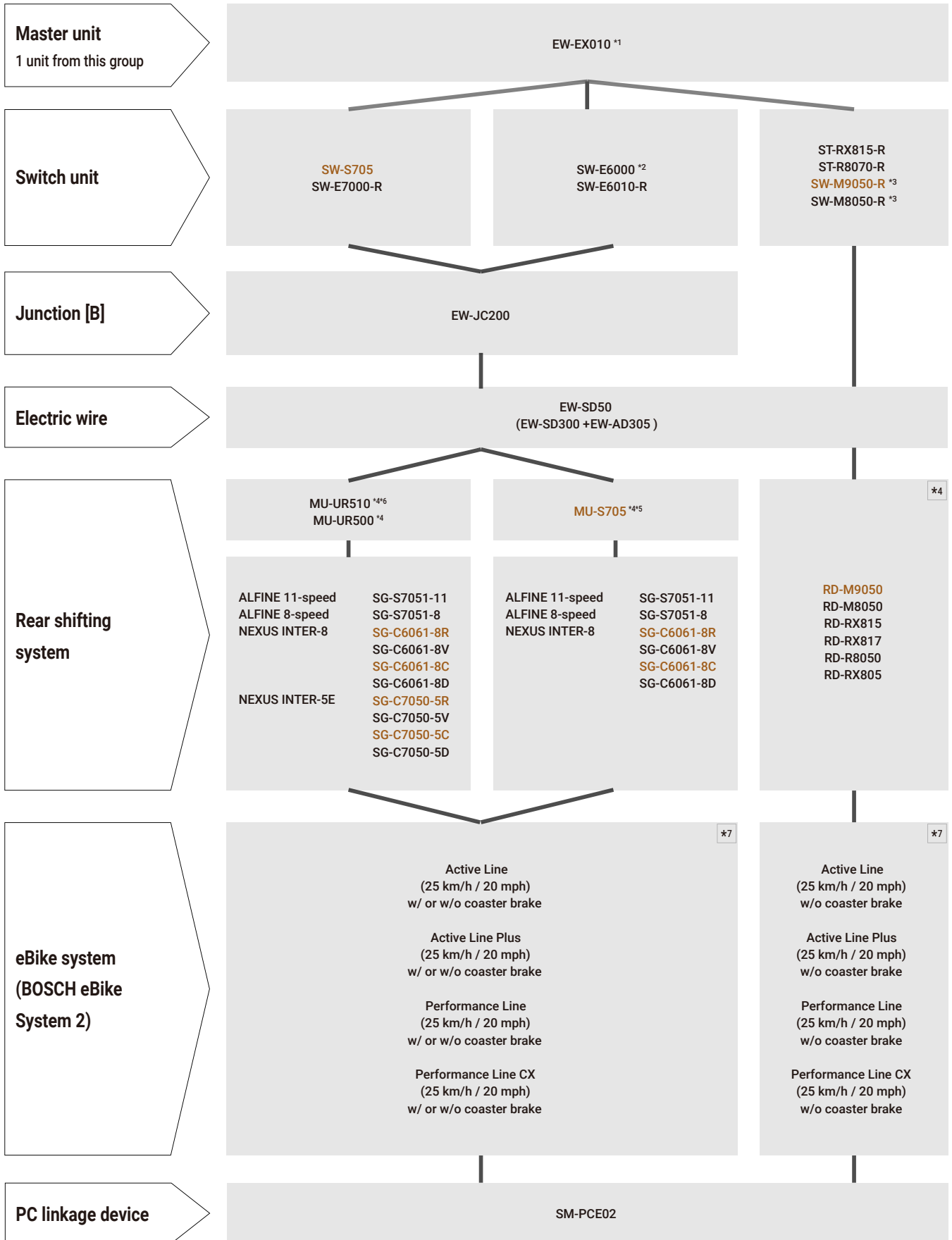

Limitation of function

- *1 EW-EX010 and BOSCH eBike system are connected by Y-harness which is provided by BOSCH
- *2 Need to change switch setting by E-TUBE PROJECT.
- *3 Cannot change manual gear shifting to automatic gear shifting and its opposite.
- *4 Automatic gear shifting is available only with internal geared hub by **MU-S705** / MU-UR500 / MU-UR510. (Not available with rear derailleur)
- *5 Compatible with 8-speed and 11-speed internal geared hub system only.
- *6 This unit has SD300 port and needs EW-AD305 for connection with SD50 port unit.
- *7 No compatibility with "Classic+ Line" and "Performance Line (45 km/h)".

Compatibility between Bracket and ID/SC

C-548

