

**ARCHIVE**

This information was updated on February 9, 2024. SHIMANO makes no warranty with respect to this information, including without limitation any warranty on the accuracy of measures, specifications and compatibility of the current products. Regarding any modification and new product information after February 9, 2024, please refer to the SHIMANO Business Customer Web Site or directly contact the sales person of our company.

**SHIMANO**

**2023-2024**

**Products compatibility Information**

Compatibilities are subject to change without prior

**Visit SHIMANO PRODUCT WEBSITE for the latest information.**

# Word definitions

<b>BB</b>	Bottom bracket	<b>HRB, BR</b>	Roller brake
<b>BC</b>	Brake outer casing	<b>I-SPEC</b>	Integration mounting system of brake lever and shifter
<b>BCC</b>	Charger cord		
<b>BCR, EC</b>	Battery charger	<b>ID</b>	CI-DECK
<b>BH</b>	Brake hose	<b>JC</b>	Junction
<b>BL</b>	Brake lever	<b>LP</b>	Light
<b>BM</b>	Battery mount	<b>MF</b>	Multiple freewheel
<b>BR</b>	Brake caliper	<b>MU</b>	Motor unit
<b>BTC</b>	Battery case	<b>O.L.D.</b>	Over Locknut Dimension
<b>BT, BTR</b>	Battery	<b>OT</b>	Shift outer casing
<b>CB</b>	Coaster brake	<b>P.C.D.</b>	Pitch Circle Diameter
<b>CC, EWC</b>	Wire cover	<b>PCE</b>	PC linkage device
<b>CD</b>	Chain device	<b>PD</b>	Pedal
<b>CG</b>	Chain guard	<b>PM</b>	POWER MODULATOR
<b>CJ</b>	Cassette joint	<b>QR</b>	Quick release
<b>CN</b>	Chain	<b>RD</b>	Rear derailleur
<b>CP</b>	Spoke protector	<b>RT, SMRT</b>	Rotor
<b>CR</b>	Chainring	<b>RTAD</b>	Rotor adapter
<b>CS</b>	Cassette	<b>SB</b>	REVOSHIFT shifter integrated with brake lever
<b>CT</b>	Chain tensioner	<b>SC</b>	Cycle computer, System information display
<b>DH</b>	Hub dynamo	<b>SF</b>	Single freewheel
<b>DU</b>	Drive unit	<b>SG</b>	Internal geared hub
<b>EW</b>	Electric wire	<b>SL</b>	Shifter
<b>EWCP</b>	Satellite charging port	<b>SPD</b>	SHIMANO PEDALING DYNAMICS
<b>EWEX</b>	Di2 adapter, CAN adapter	<b>SPD-SL</b>	SHIMANO PEDALING DYNAMICS-SL
<b>EWSW</b>	Satellite system ON/OFF switch	<b>ST</b>	DUAL CONTROL LEVER : Shifter integrated with brake lever
<b>EWW, WU</b>	Wireless unit	<b>SW</b>	Shift switch, Switch unit, Satellite shifter
<b>FC</b>	Crankset, Crank arm	<b>WH</b>	Wheel
<b>FD</b>	Front derailleur		
<b>FH</b>	FREEHUB		
<b>GM</b>	Grommet		
<b>HB</b>	Front hub		
<b>HP</b>	Head parts		

# Compatibility

## Drivetrain for MTB, LIFESTYLE components C-432

Rear drivetrain compatibility [MTB, LIFESTYLE]

C-433 C-434 C-558 C-435 C-436 C-437 C-438  
C-439 C-546

Front drivetrain compatibility [MTB, Trekking, LIFESTYLE]

C-440 C-559 C-441 C-442 C-445 C-446

Front derailleur and crankset

C-447

Front derailleur and chain line (TOURNEY)

C-448

Crankset, bottom bracket and chain line [MTB, LIFESTYLE]

C-449 C-450

## Drivetrain for ROAD, Gravel, URBAN components C-453

Rear drivetrain compatibility

C-454

Front drivetrain compatibility

C-455

## Brake system for ROAD, Gravel, URBAN, LIFESTYLE components C-737

Brake systems compatibility [ROAD]

C-456

Hydraulic systems compatibility [ROAD, Gravel]

C-499

Hydraulic systems compatibility [URBAN, LIFESTYLE]

C-500

Compatibility of BL-U8000 with shift lever

C-738

## I-SPEC C-156

Compatibility of I-SPEC shifter and brake lever

C-157

## Disc brake C-460

Disc brake caliper and disc brake rotor compatibility C-461

---

Compatibility of lock ring with hubs C-612

---

Compatibility between brake systems (MT400 series) C-606

---

Combination chart (mechanical disc brake) C-462 C-463 C-464

---

Compatibility between hydraulic disc brake hose C-186 C-732 C-733

---

Compatibility between banjo screw C-625

---

Brake pad line-up C-192 C-652 C-653

---

Disc brake mount adapter C-193 C-194 C-195

---

## Cable System C-605

Polymer-coated brake cable (BC-9000 / BC-R680) compatible chart C-306

---

## V-BRAKE and Hub roller brake C-465

Compatibility between brake systems C-466

---

Brake lever with switch compatibility C-467 C-468 C-469

---

## Cassette Sprocket C-544

FREEHUB and cassette sprocket spline compatibility C-731

---

Compatibility between rear derailleur and cassette sprocket gear teeth [ROAD, Gravel, URBAN (METREA)] C-254 C-648 C-255 C-256  
C-257 C-258 C-259

---

LINKGLIDE cassette sprocket and FREEHUB compatibility C-649

---

## URBAN (ALFINE, NEXUS) components C-470

Available combinations of the dropout, cassette sprocket/single gear and crankset for designing the frame C-471

Mechanical internal geared hub / SM (CJ) COMPATIBILITY CHART C-647

Single gear and chain combination C-608

## CARGO BIKE related components C-651

Compatibility for DIN 79010:2020-02 C-672

## Spoke protector C-298

Spoke protector C-491

MTB, Gravel, LIFESTYLE C-299

ROAD, Gravel, URBAN (METREA) C-300

Spoke protector for Road C-302

## E-BIKE compatibility chart C-431

E-BIKE system compatibility chart C-525

Drivetrain compatibility C-488 C-706 C-655 C-656 C-657 C-658 C-659

Switch unit / cycle computer and brake lever compatibility C-421

Battery and battery mount compatibility C-511

System on/off function compatibility C-629

Speed sensor and drive unit compatibility C-549

Battery and battery charger compatibility C-562

ABS compatibility C-715

## Electronic Product Information C-472

E-TUBE compatibility chart

C-473

Compatibility chart of CAN adapter for Di2

C-429

## CI-DECK C-547

Compatibility between Bracket and ID/SC

C-548

ARCHIVE

## Rear drivetrain compatibility [MTB, LIFESTYLE]

C-433

### 9,10,11-speed rear drivetrain compatibility C-434

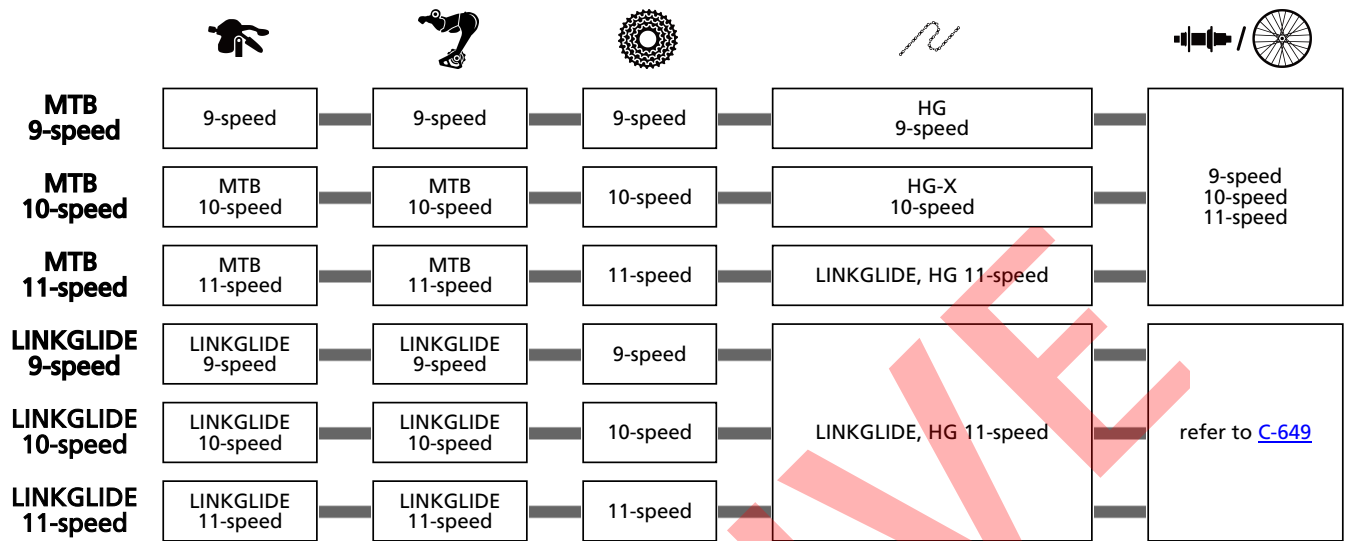

# 12-speed rear drivetrain (MICRO SPLINE) [MTB] C-558

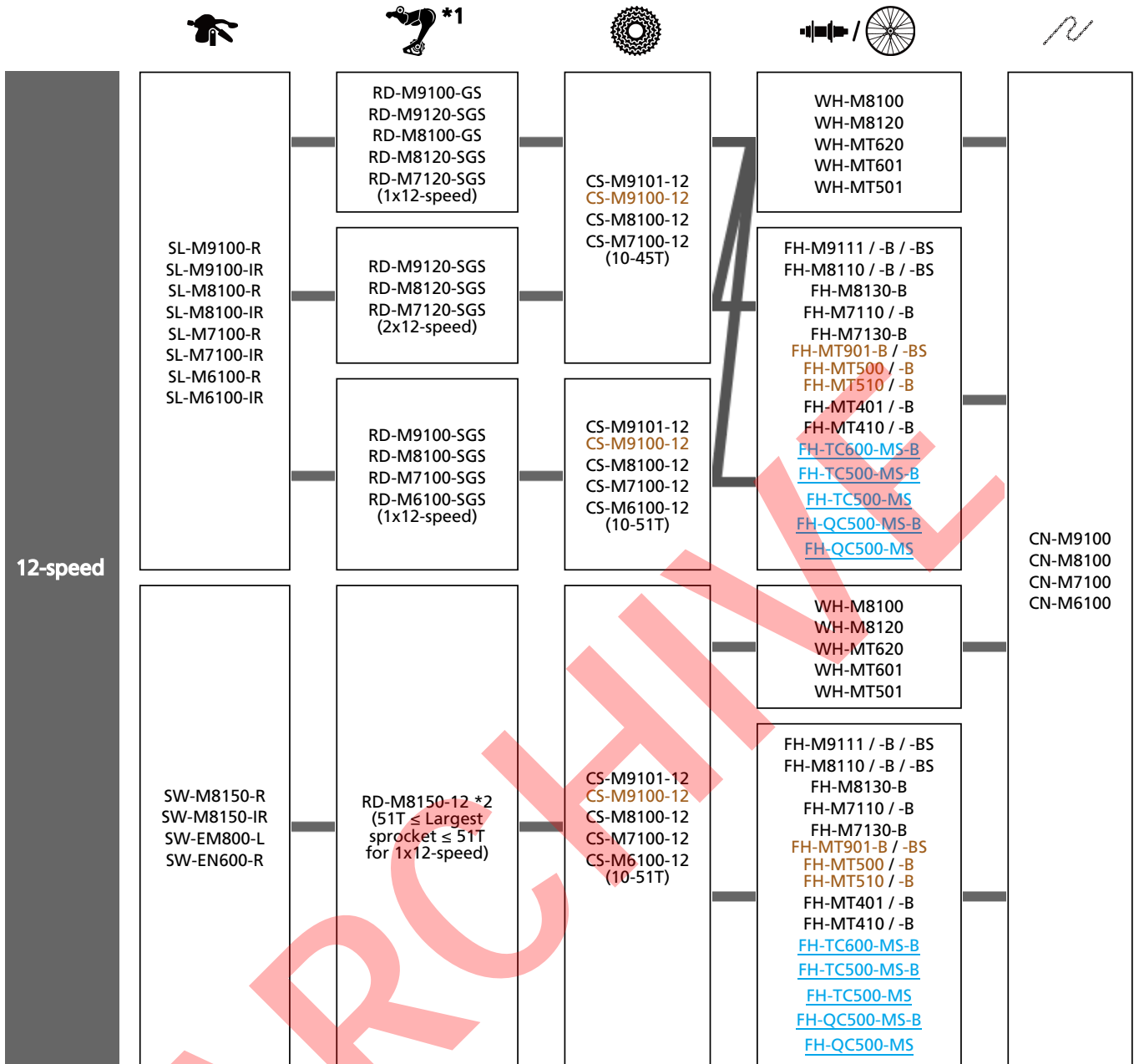

\*1 Method to adjust the end adjustment screw is different from conventional rear derailleurs. For details, refer to dealer's manual.

\*2 Only for E-BIKE



# 11-speed rear drivetrain [MTB, LIFESTYLE] C-435

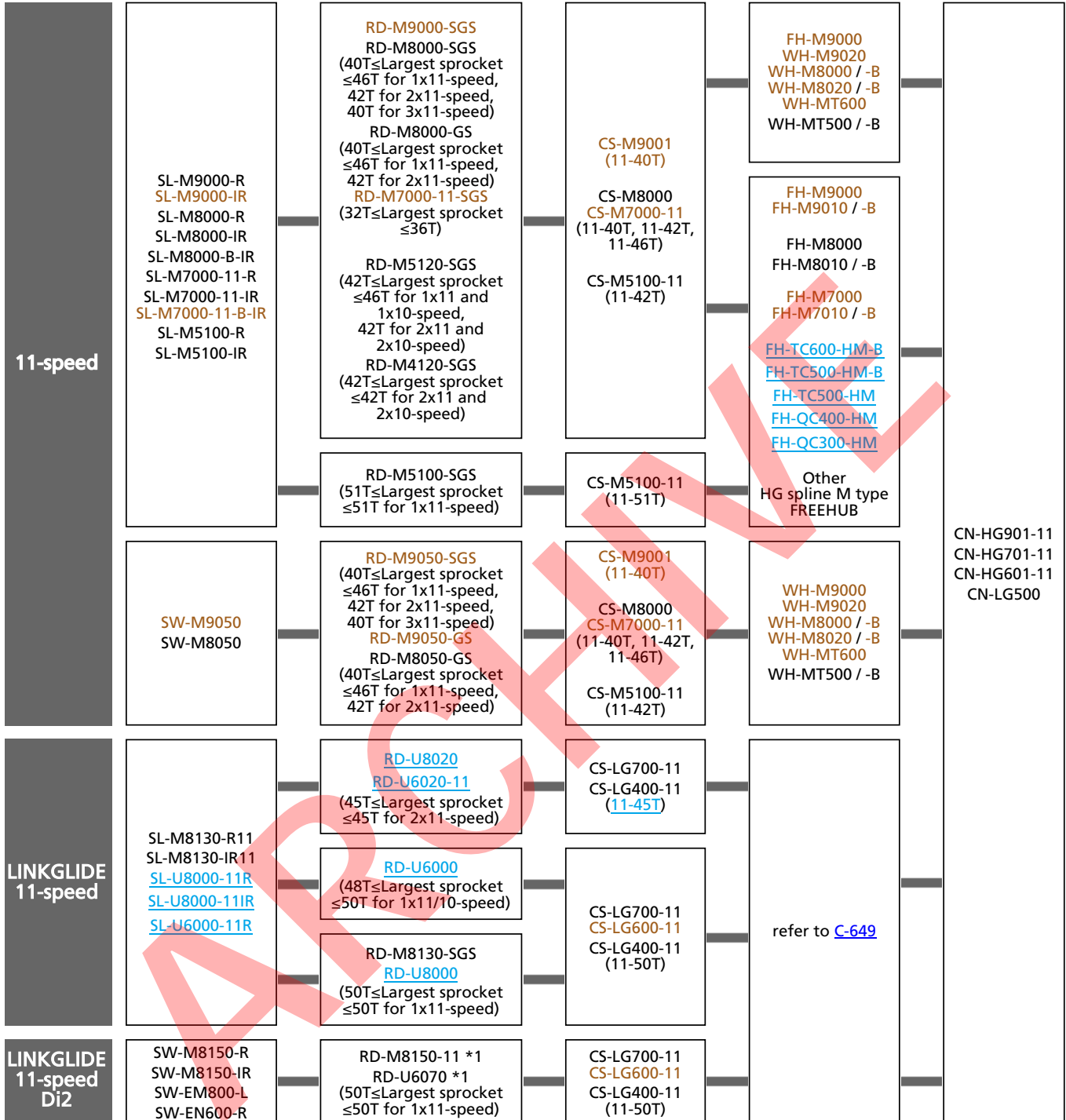
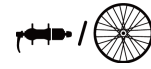

\*1 Only for E-BIKE

# 10-speed rear drivetrain [MTB, LIFESTYLE] C-436

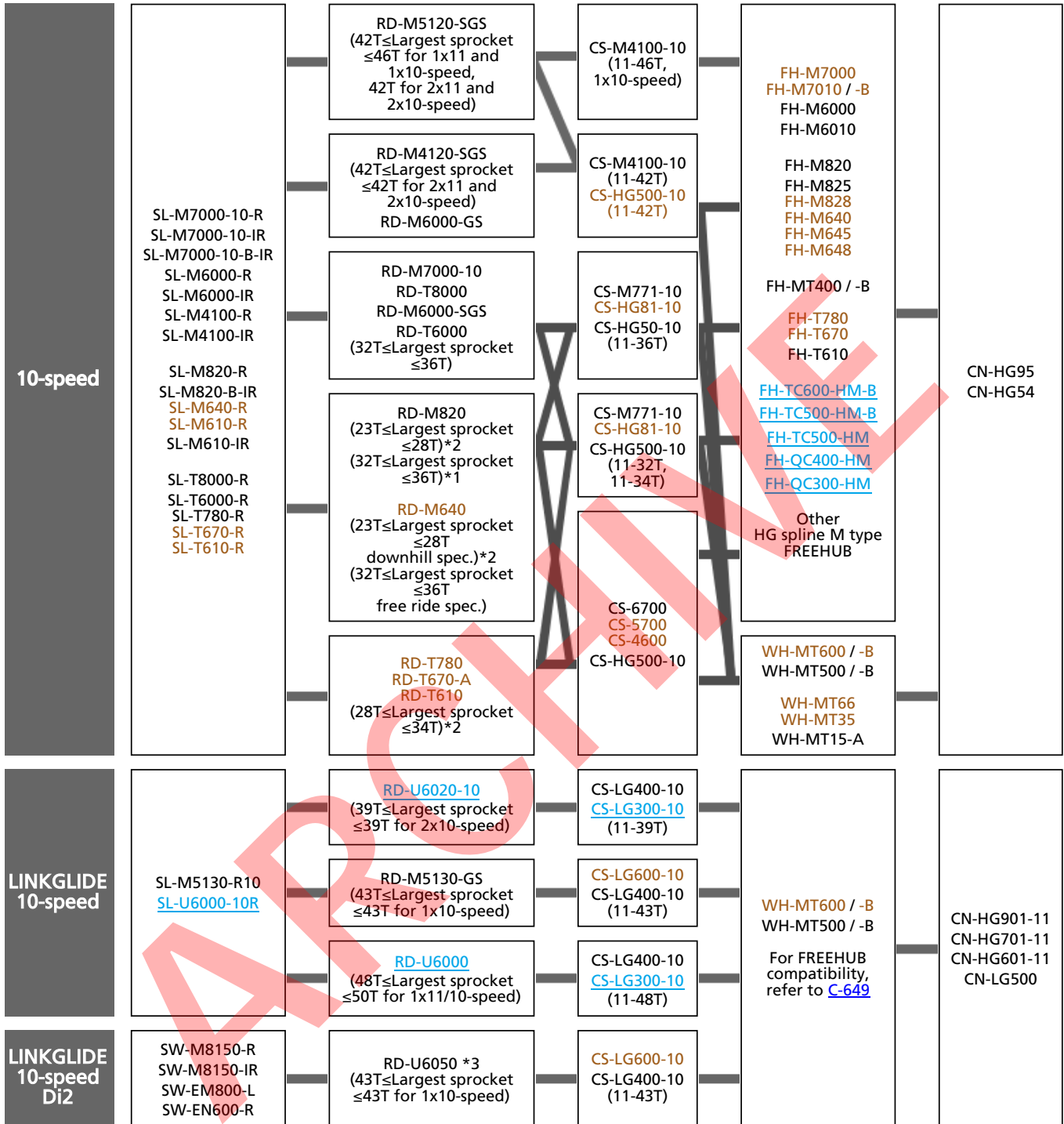
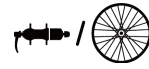

\*1 Mode converter

\*2 Compatible with road Cassette sprocket

\*3 Only for E-BIKE

# 9-speed rear drivetrain [MTB, LIFESTYLE] C-437

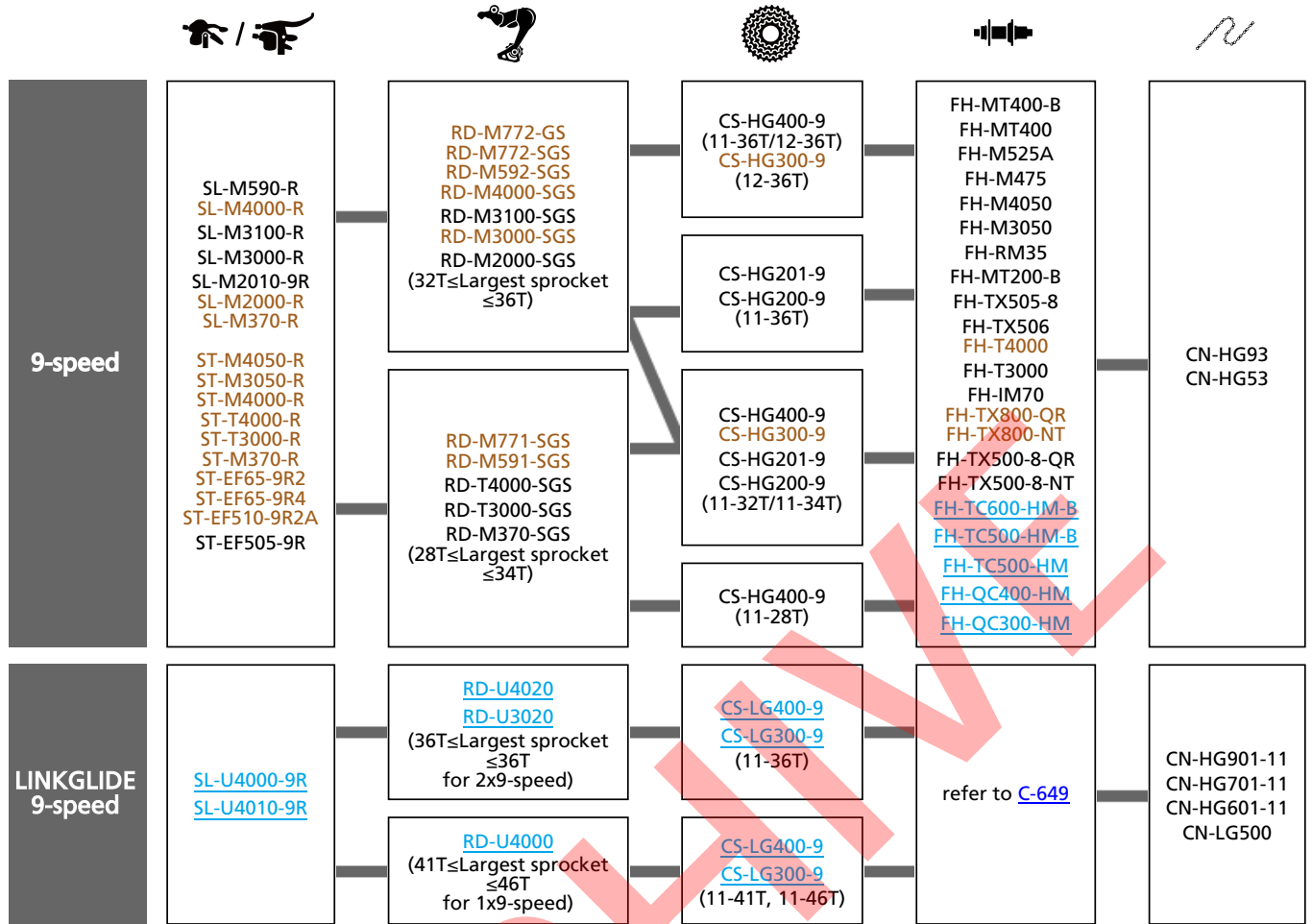

# 8-speed rear drivetrain [MTB] C-438

The rear derailleur for 8-speed can also be used for 7-speed drivetrain.

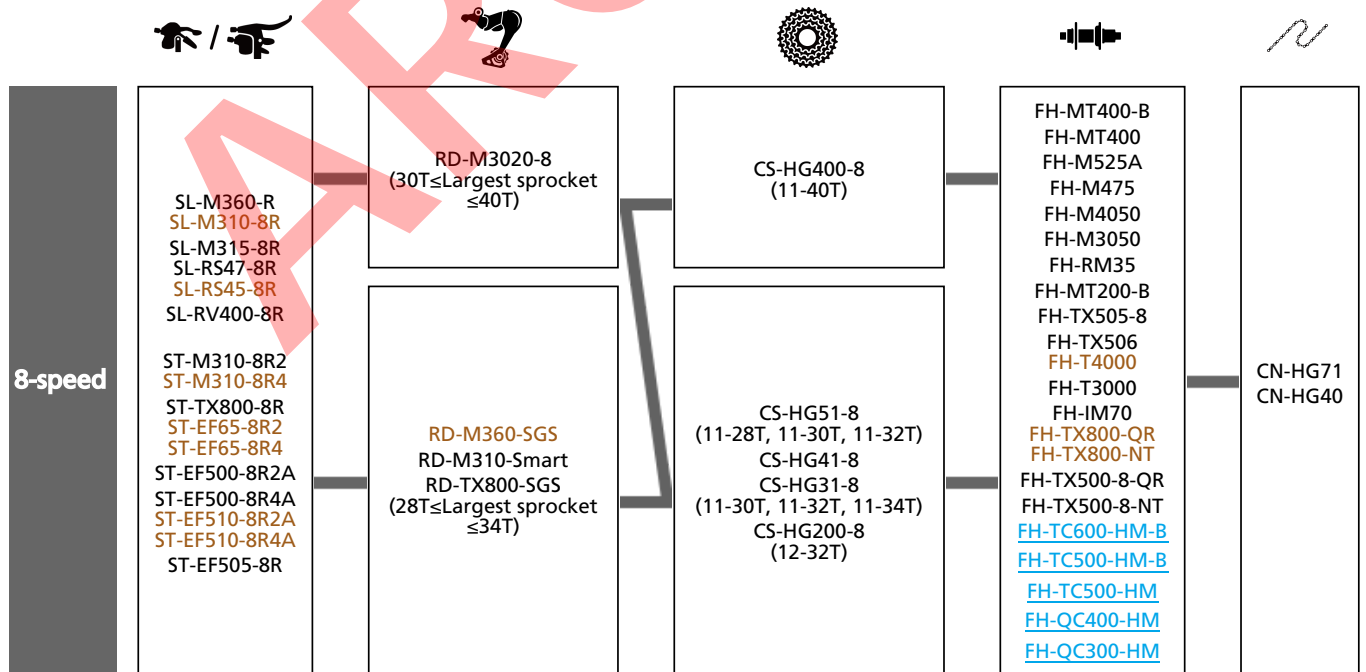

# 7-speed rear drivetrain [MTB] C-439

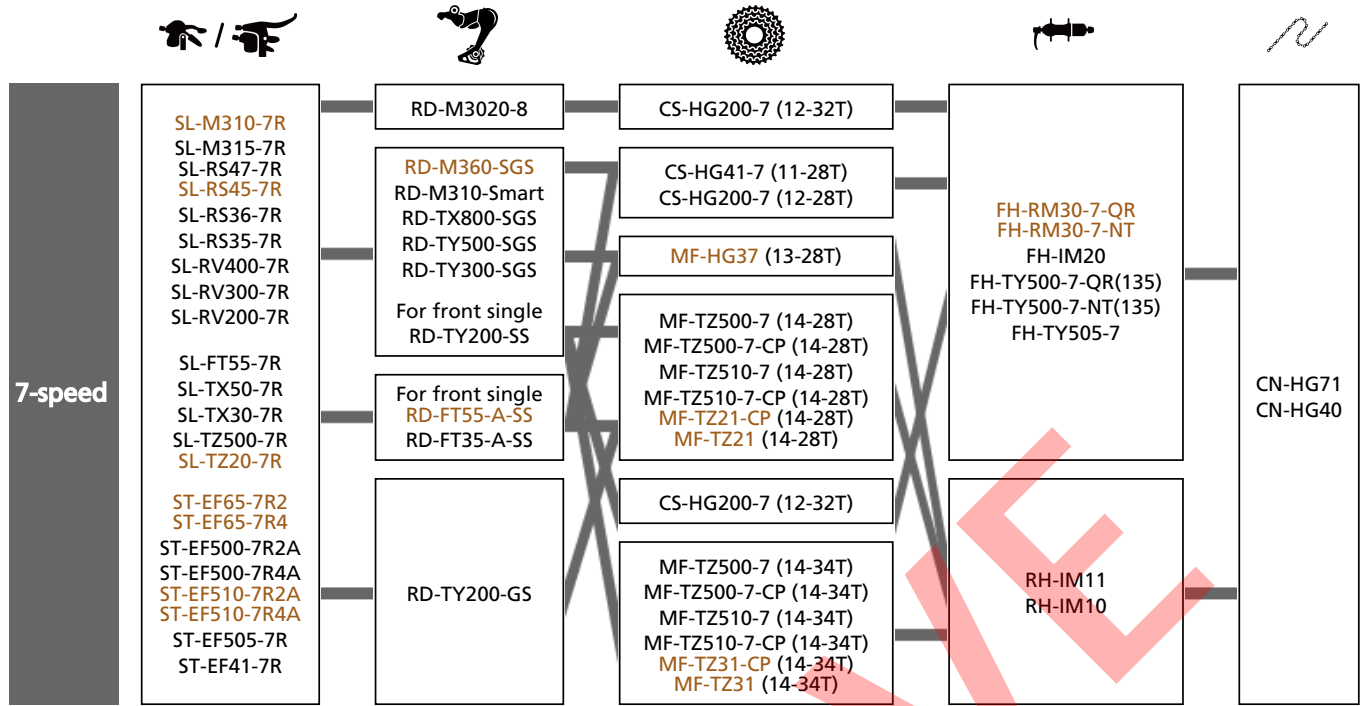

# 6-speed rear drivetrain [MTB] C-546

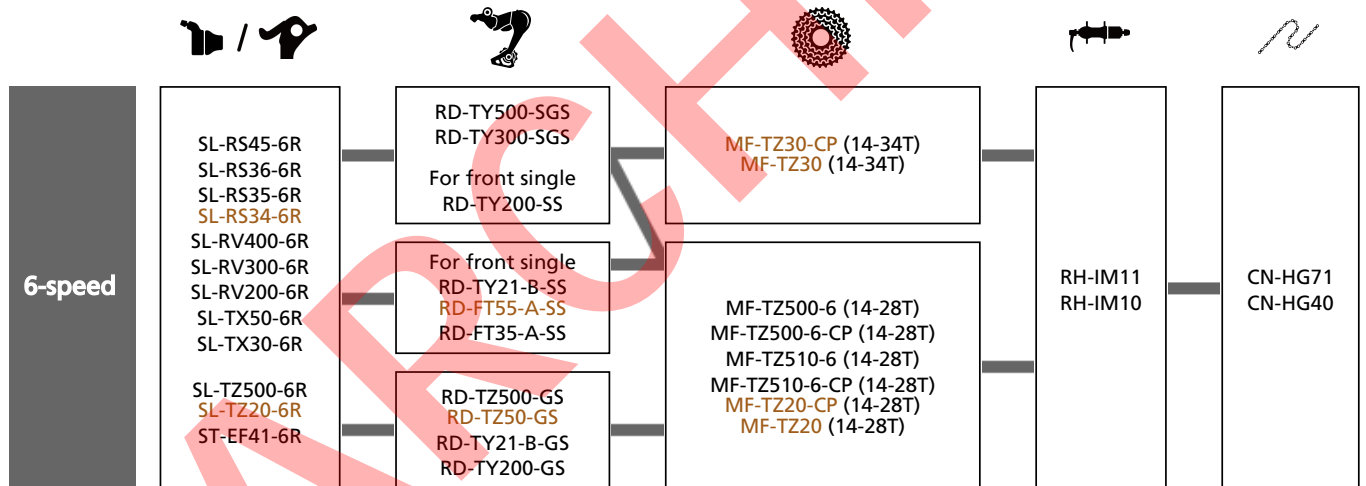

## 12-speed front drivetrain [MTB] C-559

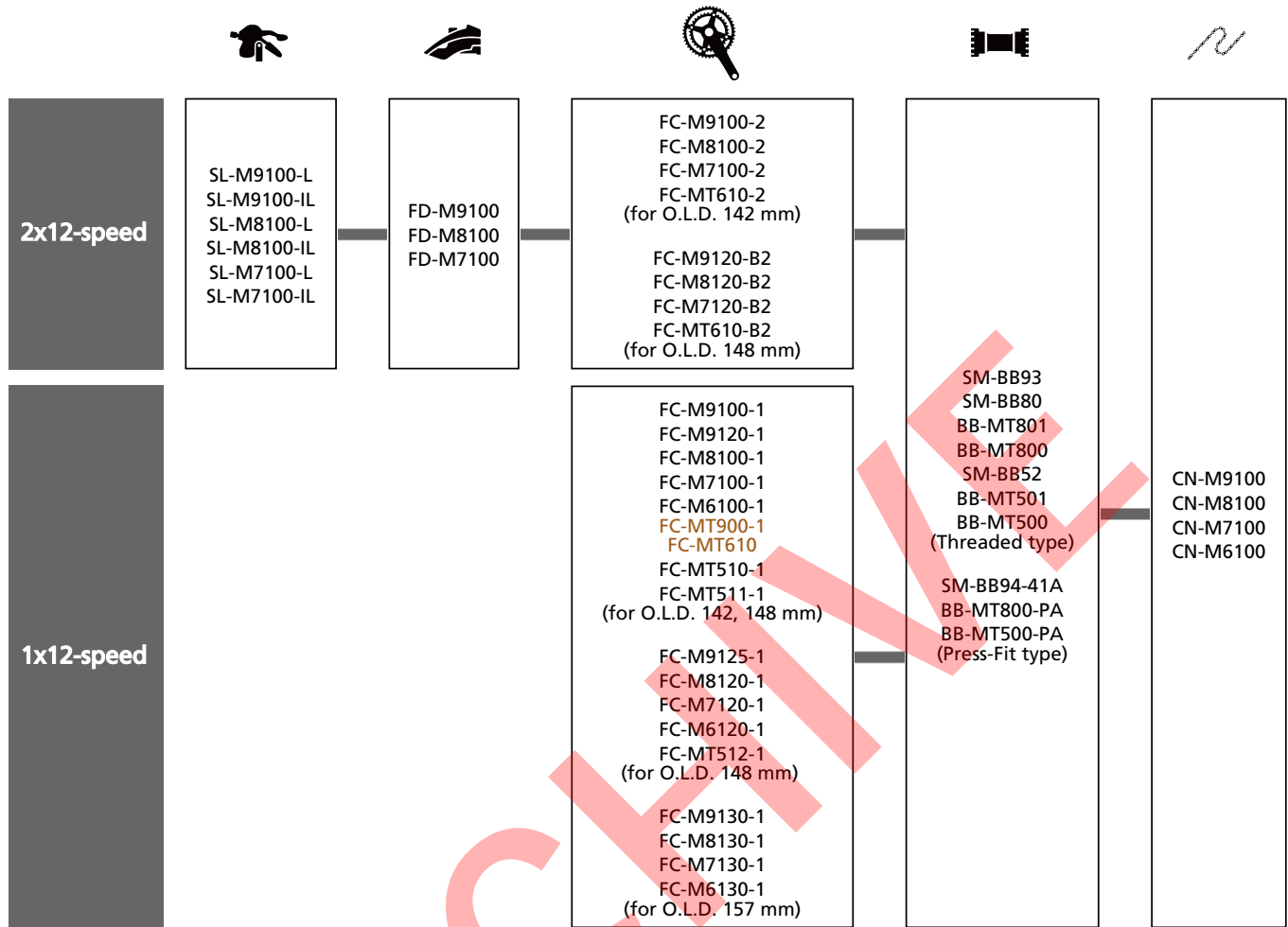

# 11-speed front drivetrain [MTB, LIFESTYLE] C-441

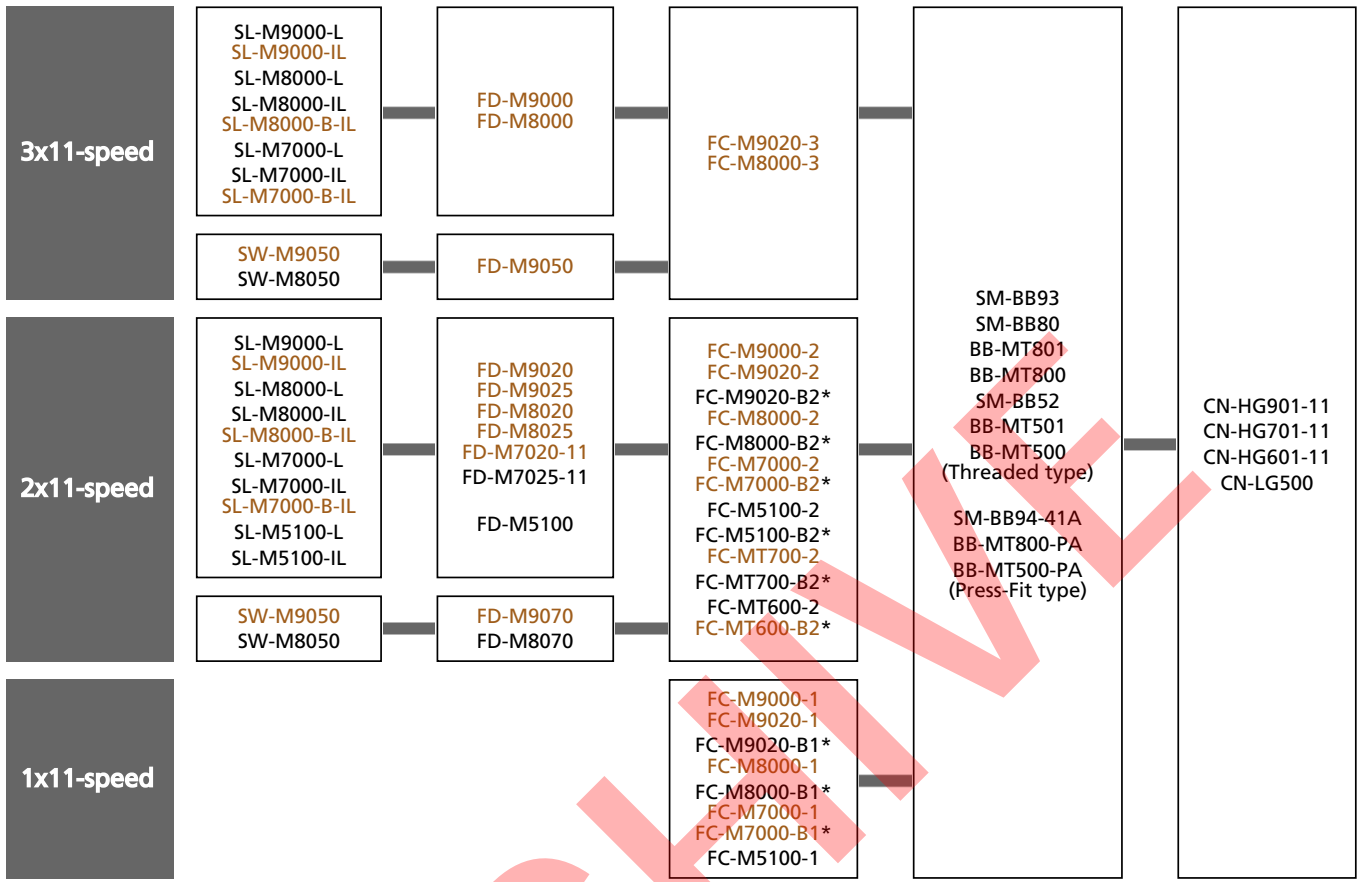

ARCHIVE

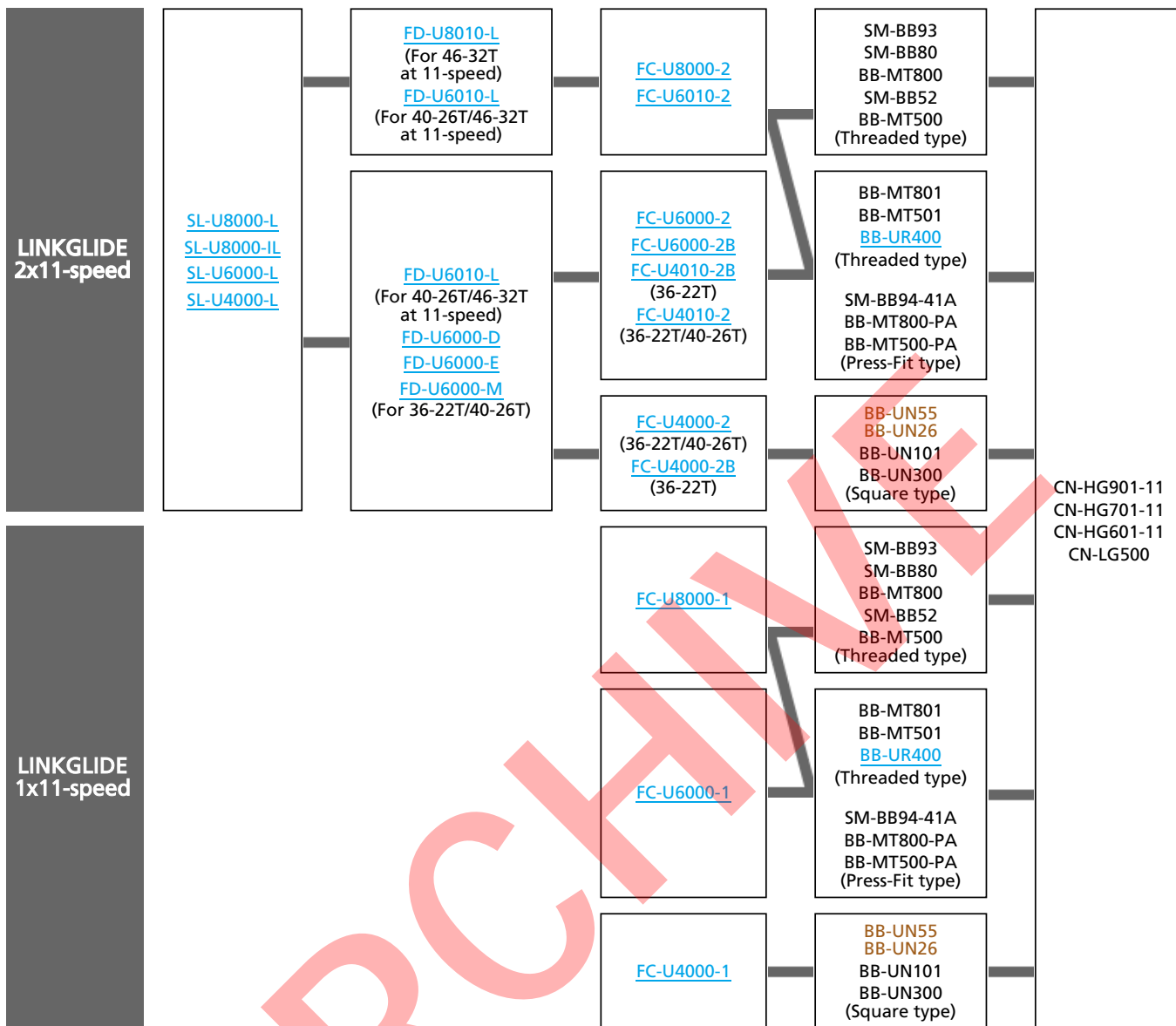

**NOTE**

Requires the dimension of frame which cassette sprocket position is 3 mm outboard.

# 10-speed front drivetrain [MTB, Trekking, LIFESTYLE] C-442

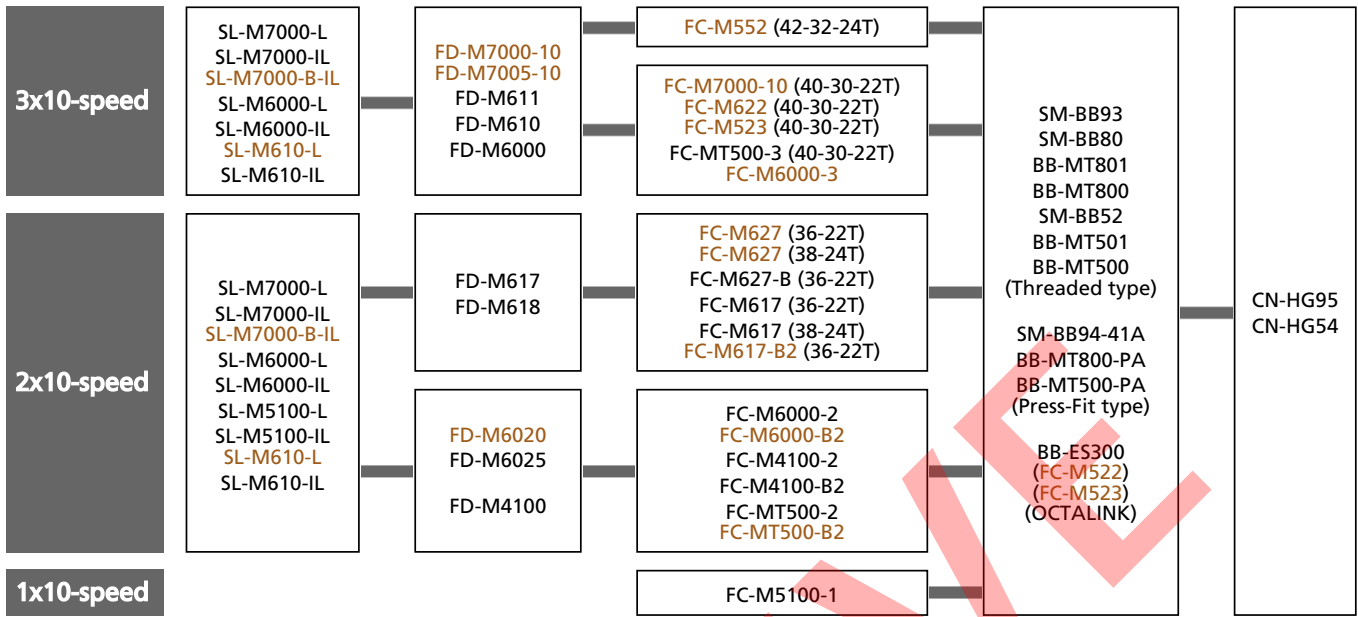

ARCHIVE



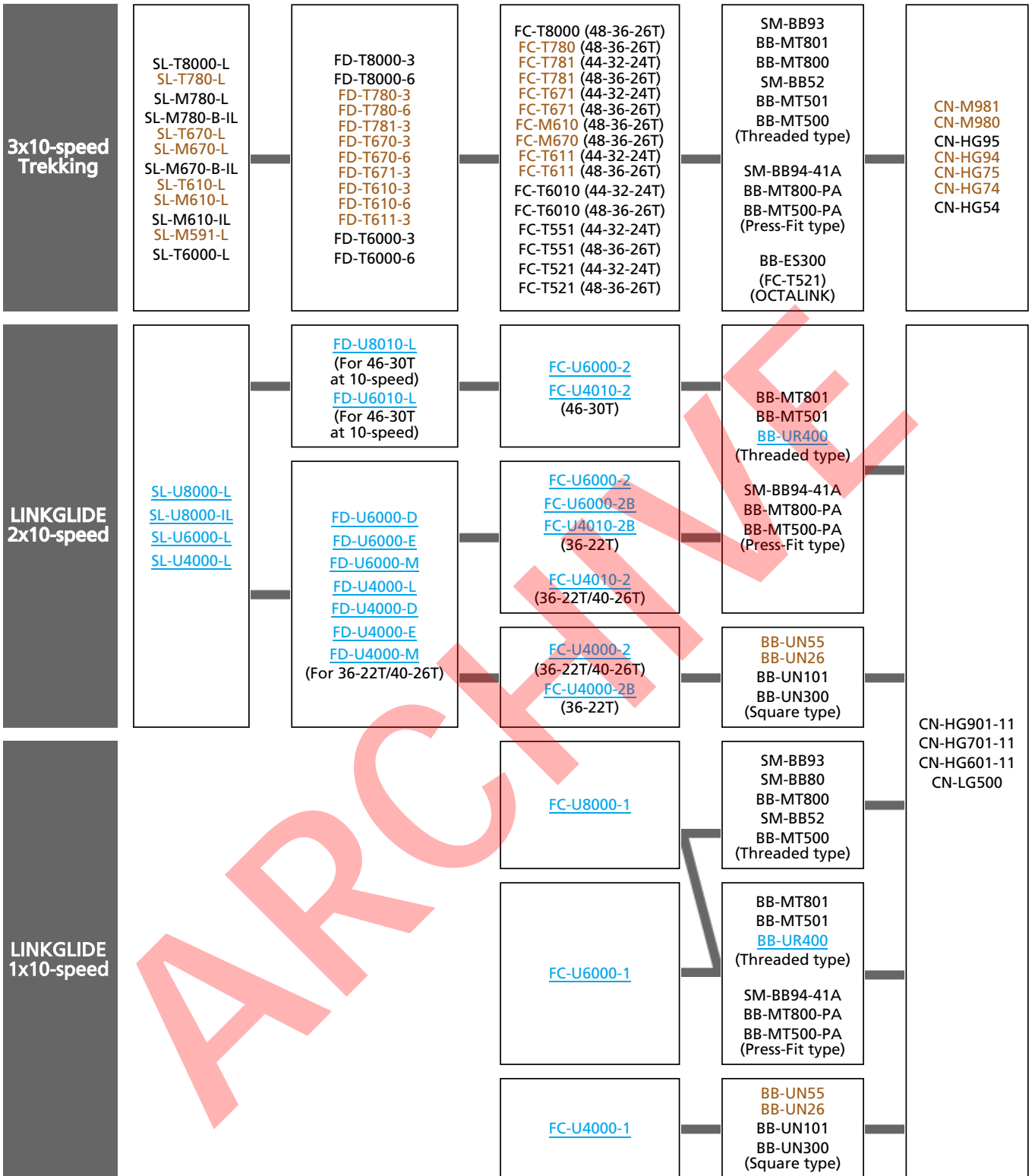

ARCHIVE

# 9-speed front drivetrain [MTB, LIFESTYLE] C-445

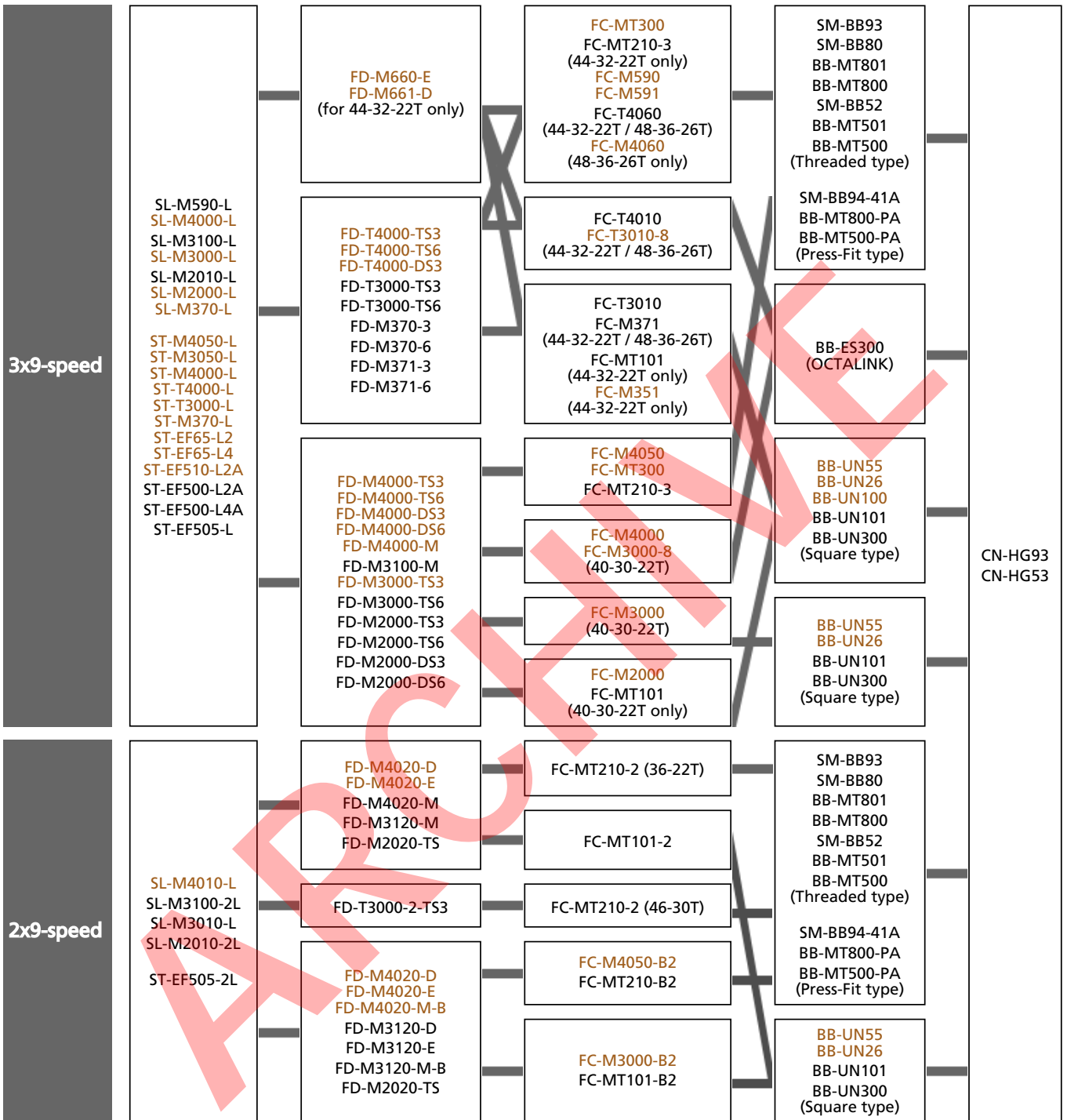
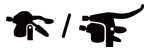



**LINKGLIDE  
2x9-speed**

[SL-U8000-L](#)  
[SL-U8000-IL](#)  
[SL-U6000-L](#)  
[SL-U4000-L](#)

[FD-U4010-L](#)  
(For 46-30T)

[FD-U4000-L](#)  
[FD-U4000-D](#)  
[FD-U4000-E](#)  
[FD-U4000-M](#)  
(For 36-22T/40-26T)

[FC-U6000-2](#)  
[FC-U4010-2](#)  
(46-30T)

[FC-U6000-2](#)  
[FC-U6000-2B](#)  
[FC-U4010-2B](#)  
(36-22T)

[FC-U4000-2](#)  
(36-22T/40-26T)  
[FC-U4000-2B](#)  
(36-22T)

[BB-MT801](#)  
[BB-MT501](#)  
[BB-UR400](#)  
(Threaded type)

[SM-BB94-41A](#)  
[BB-MT800-PA](#)  
[BB-MT500-PA](#)  
(Press-Fit type)

[BB-UN55](#)  
[BB-UN26](#)  
[BB-UN101](#)  
[BB-UN300](#)  
(Square type)

**LINKGLIDE  
1x9-speed**

[FC-U8000-1](#)

[FC-U6000-1](#)

[FC-U4000-1](#)

[SM-BB93](#)  
[SM-BB80](#)  
[BB-MT800](#)  
[SM-BB52](#)  
[BB-MT500](#)  
(Threaded type)

[BB-MT801](#)  
[BB-MT501](#)  
[BB-UR400](#)  
(Threaded type)

[SM-BB94-41A](#)  
[BB-MT800-PA](#)  
[BB-MT500-PA](#)  
(Press-Fit type)

[BB-UN55](#)  
[BB-UN26](#)  
[BB-UN101](#)  
[BB-UN300](#)  
(Square type)

[CN-HG901-11](#)  
[CN-HG701-11](#)  
[CN-HG601-11](#)  
[CN-LG500](#)

ARCHIVED

# 8,7,6-speed front drivetrain [MTB] C-446

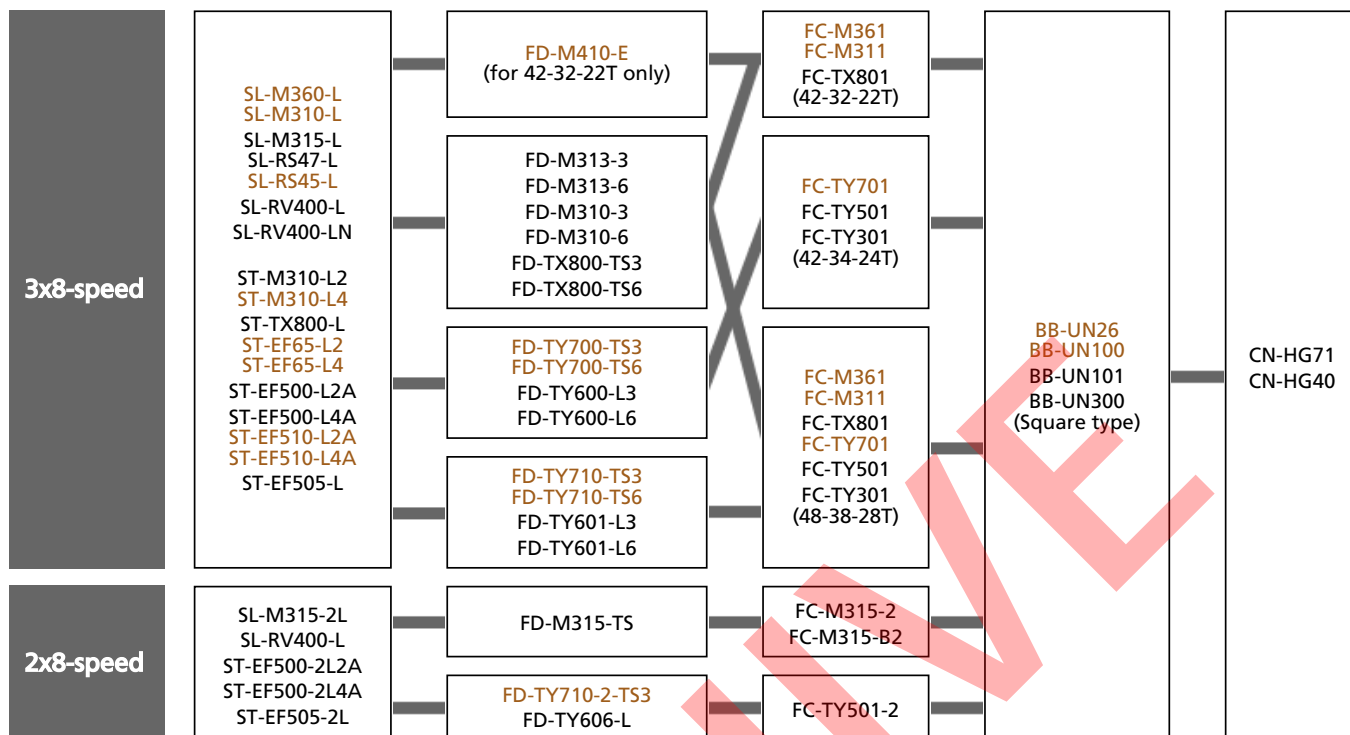

ARCHIVE

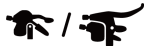

**3x7-speed**

SL-M310-L  
 SL-M315-L  
 SL-RS47-L  
 SL-RS45-L  
 SL-RS36-L  
 SL-RS35-L  
 SL-RV400-L  
 SL-RV300-L  
 SL-RV200-L  
 SL-TX50-L

ST-EF65-L2  
 ST-EF65-L4  
 ST-EF500-L2A  
 ST-EF500-L4A  
 ST-EF505-L  
 ST-EF510-L2A  
 ST-EF510-L4A  
 ST-EF41-L

FD-M410-E  
 (for 42-32-22T only)

FD-M313-3  
 FD-M313-6  
 FD-M310-3  
 FD-M310-6  
 FD-TX800-TS3  
 FD-TX800-TS6

FD-TY700-TS3  
 FD-TY700-TS6  
 FD-TY600-L3  
 FD-TY600-L6

FD-TY500-TS3  
 FD-TY500-TS6

FD-TY300-DS6(475)  
 FD-TY300-DS6(50)

FD-TY710-TS3  
 FD-TY710-TS6  
 FD-TY601-L3  
 FD-TY601-L6

FD-TY510-TS3  
 FD-TY510-TS6

FC-M361  
 FC-M311  
 FC-TX801  
 (42-32-22T)

FC-M361  
 FC-M311  
 FC-TX801  
 FC-TY701  
 FC-TY501  
 FC-TY301  
 (48-38-28T)

FC-TY701  
 FC-TY501  
 FC-TY301  
 (42-34-24T)

FC-M361  
 FC-M311  
 FC-TX801  
 FC-TY701  
 FC-TY501  
 FC-TY301  
 (48-38-28T)

SL-TX30-LN  
 SL-TZ500-LN  
 SL-TZ20-LN  
 SL-RS36-LN  
 SL-RS35-LN  
 SL-RV400-LN  
 SL-RV300-LN  
 SL-RV200-LN  
 SL-TX50-LN

FD-TY700-TS3  
 FD-TY700-TS6  
 FD-TY600-L3  
 FD-TY600-L6

FD-TY500-TS3  
 FD-TY500-TS6

FD-TY300-DS6(475)  
 FD-TY300-DS6(50)

FD-TZ500-DS6  
 FD-TZ30

FD-TY510-TS3  
 FD-TY510-TS6

FD-TZ510-DS6  
 FD-TZ31

FC-TY701  
 FC-TY501  
 FC-TY301  
 (42-34-24T)

FC-M361  
 FC-M311  
 FC-TX801  
 FC-TY701  
 FC-TY501  
 FC-TY301  
 (48-38-28T)

**2x7-speed**

SL-M315-2L  
 SL-RV400-L  
 ST-EF500-2L2A  
 ST-EF500-2L4A  
 ST-EF505-2L

FD-M315-TS

FD-TY710-2-TS3  
 FD-TY606-L

FC-M315-2  
 FC-M315-B2

FC-TY501-2

BB-UN26  
 BB-UN100  
 BB-UN101  
 BB-UN300  
 (Square type)

CN-HG71  
 CN-HG40

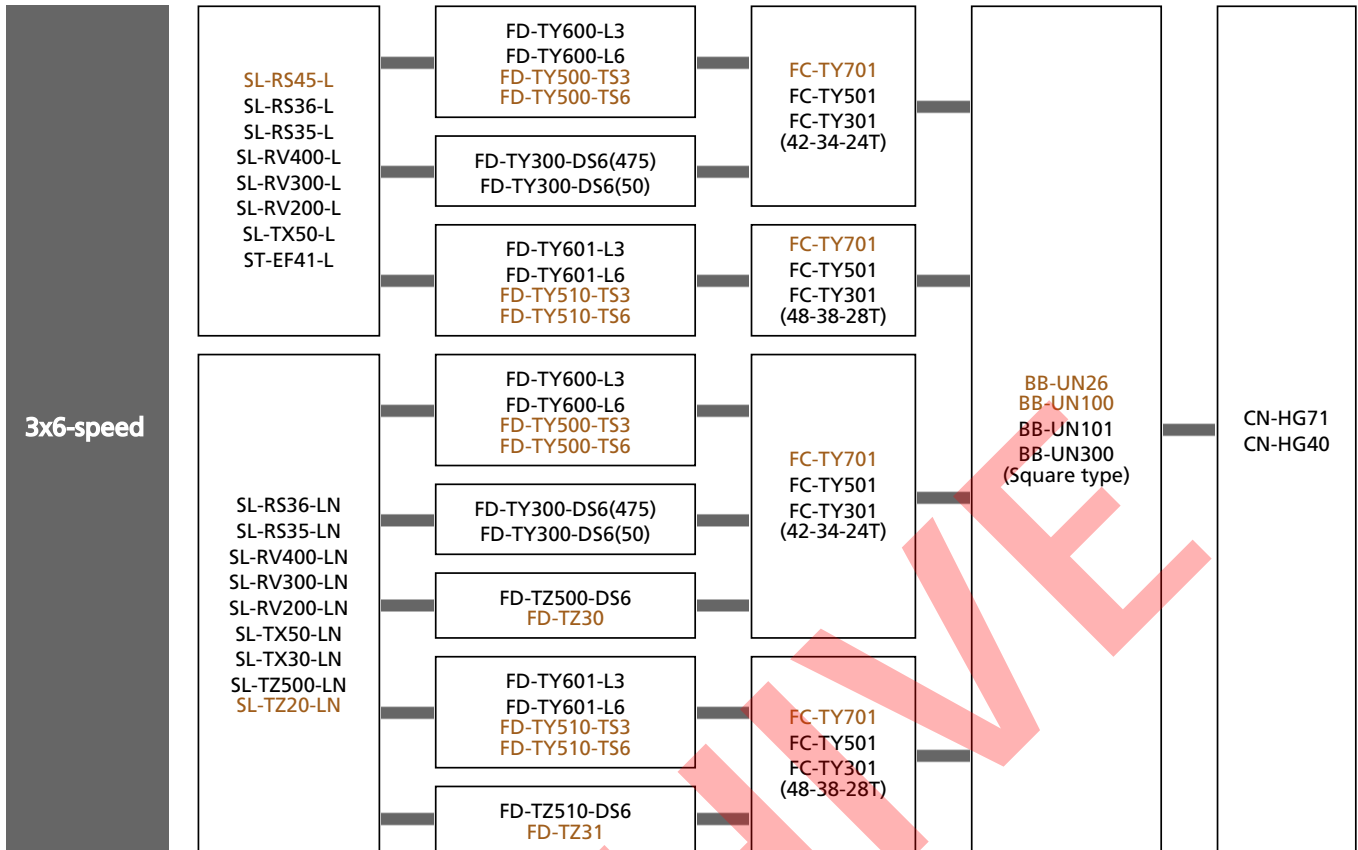

## Front derailleur and crankset

C-447

The allowable combinations of front derailleurs depend on the difference in the number of teeth of the gears and the shape of the front derailleur plate.

If the conditions given below are not satisfied, then the desired shiftability may not be obtained.

$$FC \text{ (largest chainring) - (smallest chainring)} \leq FD \text{ (high and low capacity)}$$

$$FC \text{ (largest chainring) - (middle chainring)} = FD \text{ (allowance of difference in teeth number between top and middle)}$$

Each front derailleurs and the number of teeth of corresponding cranksets are given in the compatibility chart.

## Front derailleur and chain line (TOURNEY)

C-448

The SHIMANO line-up for front derailleurs and the chain lines they support are given in the chart below.

		28.6 mm (S)	31.8 mm (M)	34.9 mm (L)
Chain line (mm)	FD-TY300-DS6(475)		47.5	-
	FD-TY300-DS6(50)		-	50.0
	FD-TZ510-DS6 FD-TZ500-DS6 FD-TZ31 FD-TZ30		47.5	-
	FD-TY600-L3 FD-TY600-L6	-	47.5	47.5
			50	50
	FD-TY601-L3 FD-TY601-L6	-	47.5	47.5
		50	50	

# Crankset, bottom bracket and chain line [MTB, LIFESTYLE]

C-449

In order to use SIS (SHIMANO INDEX SYSTEM) to its full extent, the required correct chain line, along with the crankset and bottom bracket required to obtain that, are given in the chart below.

## Separate type FC-BB compatibility [MTB, LIFESTYLE] C-450

### 11, 10, 9-speed

Speed	Series	Crankset				Bottom bracket	Chain line and axle mark							
		Model No.	Type of crank				Model No.	47.5 mm	50.0 mm	52.5 mm	47.5+t mm	48.8 mm	51.8 mm	52 mm
			OCTALINK	Square	Chain case									
11, 10, 9	SHIMANO CUES	<a href="#">FC-U4000-1 (40T/42T)</a>	-	✓	✓*1	BB-UN300 (-K) BB-UN101 (-K)	-	LL123	-	-	-	-	-	-
		<a href="#">FC-U4000-1 (30T/32T)</a>	-	✓	-	BB-UN300 BB-UN101	-	-	-	-	-	-	-	LL123
		<a href="#">FC-U4000-2</a>	-	✓	-	BB-UN300 BB-UN101	-	-	-	-	LL123	-	-	-
		<a href="#">FC-U4000-2B</a>	-	✓	-	BB-UN300 BB-UN101	-	-	-	-	-	LL123	-	-
10	SHIMANO	<a href="#">FC-M523</a>	✓	-	-	BB-ES300	-	118	-	-	-	-	-	-
		<a href="#">FC-M522</a>	✓	-	-	BB-ES300	-	113	-	-	-	-	-	-
9	SHIMANO	<a href="#">FC-M521</a>	✓	-	✓*1	BB-ES300-AK	-	*2	-	-	-	-	-	-
		<a href="#">FC-M4000</a>	✓	-	-	BB-ES300	-	118	-	-	-	-	-	-
	ALIVIO	<a href="#">FC-T4010</a>	✓	-	✓*1	BB-ES300(-K)	-	126(-K)	-	-	-	-	-	-
		<a href="#">FC-M430-8</a>	✓	-	-	BB-ES300(-E)	-	118(-E)	-	-	-	-	-	-
		<a href="#">FC-M430</a>	-	✓	-	BB-UN26(-E) BB-UN300(-E)	-	LL113(-E)	-	-	-	-	-	-
	ACERA	<a href="#">FC-M3000-8</a>	✓	-	-	BB-ES300	-	118	-	-	-	-	-	-
		<a href="#">FC-M3000</a> <a href="#">FC-M3000-B2</a>	-	✓	-	BB-UN26 BB-UN300	-	LL113	-	-	-	-	-	-
		<a href="#">FC-T3010-8</a>	✓	-	✓*1	BB-ES300(-K)	-	126(-K)	-	-	-	-	-	-
		<a href="#">FC-T3010</a>	-	✓	✓*1	BB-UN26(-K) BB-UN300 (-K)	-	LL123(-K)	-	-	-	-	-	-
	ALTUS	<a href="#">FC-M2000</a>	-	✓	-	BB-UN26 BB-UN300 BB-UN100 BB-UN101	-	LL123(-K)	-	-	-	-	-	-
	SHIMANO	<a href="#">FC-MT100</a> <a href="#">FC-MT101</a>	-	✓	-	BB-UN26 BB-UN300 BB-UN100 BB-UN101	-	LL123	-	-	-	-	-	-
		<a href="#">FC-M371</a>	-	✓	-	BB-UN26(-K) BB-UN300 (-K)	-	LL123(-K)	-	-	-	-	-	-
		<a href="#">FC-M351</a>	-	✓	✓*1	BB-UN26(-K) BB-UN300 (-K)	-	LL123(-K)	-	-	-	-	-	-

\*1 Chain case stay thickness should be 1.5 mm to 2.1 mm.

\*2 Please refer to [C-445](#) for detailed combination.

#### NOTE

- If using a chain case, select a BB-xxxx (-K) / -K bottom bracket.
- If using an E-type front derailleur, select a BB-xxxx (-E) bottom bracket.
- [FC-M521](#): Use 121AK with 1.8 mm spacer if no chain case used.

## 8, 7, 6-speed

Speed	Series	Crankset				Bottom bracket	Chain line and axle mark							
		Model No.	Type of crank				Model No.	47.5 mm	50.0 mm	52.5 mm	47.5+t mm	48.8 mm	51.8 mm	52 mm
			OCTALINK	Square	Chain case									
8, 7	ACERA ALTUS	FC-M361 FC-M311	-	✓	✓*1	BB-UN26(-K) BB-UN300 (-K)	-	LL123(-K)	-	-	-	-	-	
	TOURNEY	FC-TX801	-	✓	✓*1	BB-UN26(-K) BB-UN300 (-K) BB-UN100 (-K) BB-UN101 (-K)	-	LL123(-K)	-	-	-	-	-	
	SHIMANO	FC-M315-2	-	✓	-	BB-UN26 BB-UN300 BB-UN100 BB-UN101	-	-	-	-	LL123	-	-	
		FC-M315-B2	-	✓	-	BB-UN26 BB-UN300 BB-UN100 BB-UN101	-	-	-	-	-	LL123	-	
		FC-TY501-2	-	✓	-	BB-UN26 BB-UN300 BB-UN100 BB-UN101	-	-	-	-	LL123	-	-	
	8, 7, 6	SHIMANO	FC-TY701 FC-TY501 FC-TY301	-	✓	✓	BB-UN26(-K) BB-UN300 (-K) BB-UN100 (-K) BB-UN101 (-K)	D-NL (122.5)	BB-UN26 (-K) BB-UN300 (-K) D-EL (-K)	-	D-NL-K (122.5)	-	-	-

\*1 Chain case stay thickness should be 1.5 mm to 2.1 mm.

### NOTE

- If using a chain case, select a BB-xxxx (-K) / -K bottom bracket.
- If using an E-type front derailleur, select a BB-xxxx (-E) bottom bracket.



## Rear drivetrain compatibility

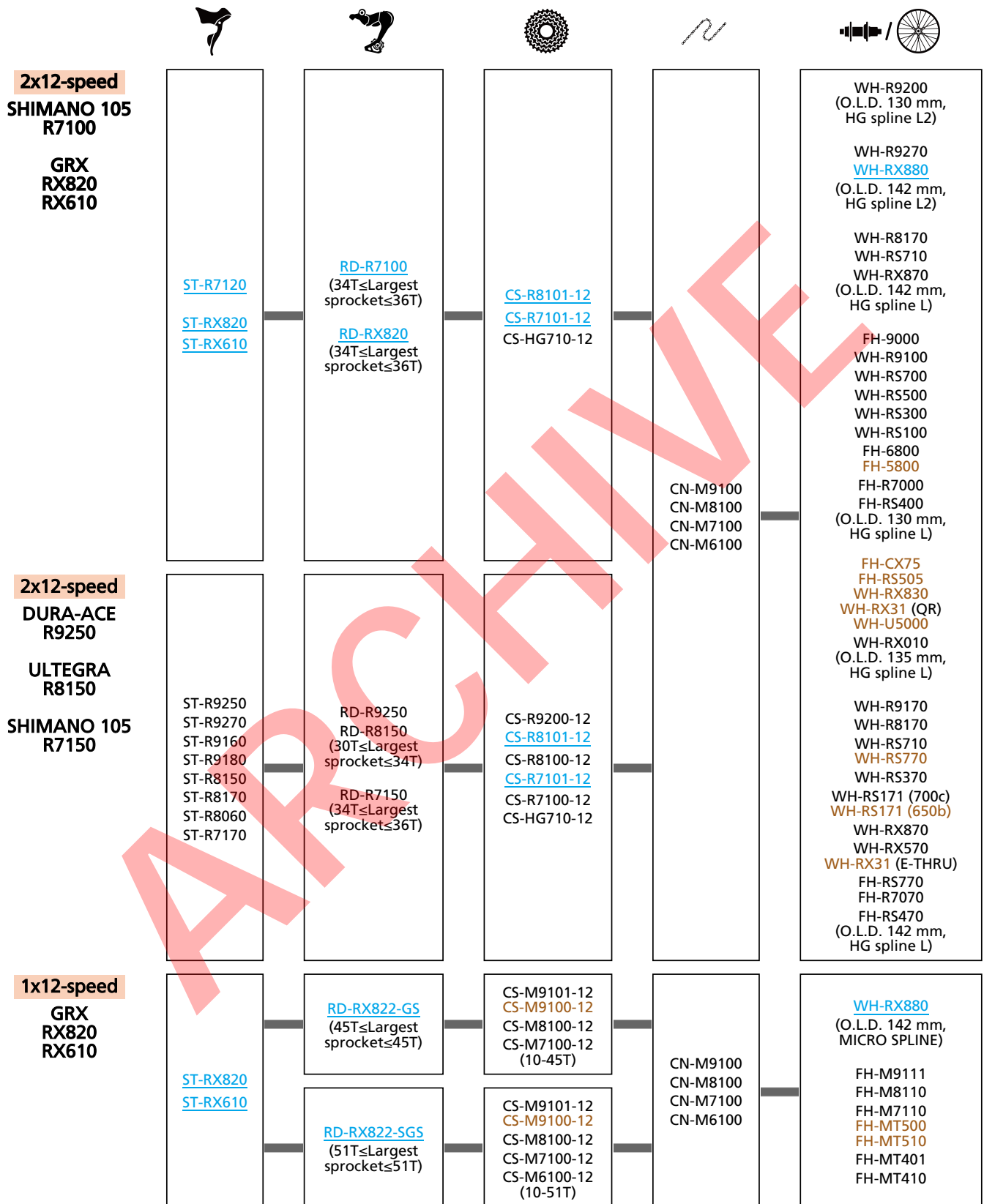

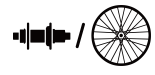

**2x11-speed**

**DURA-ACE  
R9100  
9000**

**ULTEGRA  
R8000  
6800**

**SHIMANO 105  
R7000  
5800**

**METREA  
U5000**

**GRX  
RX810  
RX600**

ST-R9100  
ST-R9120  
ST-9001  
**ST-9000**  
SL-BSR1  
ST-R8000  
ST-R8020  
ST-R8025  
ST-6800  
ST-R7000  
ST-R7020  
ST-R7025  
ST-5800

SL-RS700  
ST-RS685  
**ST-RS505**

**ST-U5060**  
**SL-U5000**  
ST-RX810  
ST-RX600

ST-R9150  
ST-R9160  
ST-R9170  
ST-R9180  
**ST-9070**  
ST-R8050  
ST-R8060  
ST-R8070  
**ST-9071**

ST-6870  
ST-6871  
ST-RX815  
**ST-R785**

RD-R9100-SS  
RD-R8000-SS  
(25T≤Largest sprocket≤30T)

RD-R8000-GS  
RD-RX800-GS  
(28T≤Largest sprocket≤34T)

RD-9000  
RD-6800-SS  
**RD-5800-SS**  
(23T≤Largest sprocket≤28T)

RD-R7000-SS  
(25T≤Largest sprocket≤30T)

RD-R7000-GS  
(28T≤Largest sprocket≤34T)

RD-6800-GS  
**RD-5800-GS**  
(28T≤Largest sprocket≤32T)

**RD-U5000-SS**  
(28T≤Largest sprocket≤32T)

RD-RX810  
(30T≤Largest sprocket≤34T)

RD-RX800  
(28T≤Largest sprocket≤34T)

RD-R9150-SS  
RD-R8050-SS  
(25T≤Largest sprocket≤30T)

**RD-9070-SS**  
RD-6870-SS  
(23T≤Largest sprocket≤28T)

RD-R8050-GS  
RD-RX805  
(28T≤Largest sprocket≤34T)

RD-6870-GS  
(28T≤Largest sprocket≤32T)

RD-RX815  
(30T≤Largest sprocket≤34T)

**CS-R9100**

**CS-9000**  
**CS-6800**  
**CS-5800**  
CS-R8000  
CS-HG800-11  
CS-R7000  
CS-HG700-11

**CN-9000**

**CN-6800**  
CN-HG901-11  
CN-HG701-11  
CN-HG601-11  
CN-LG500

FH-9000  
WH-R9100  
WH-RS700  
WH-RS500  
WH-RS300  
WH-RS100  
FH-6800  
**FH-5800**  
FH-R7000  
FH-RS400  
(O.L.D. 130 mm)

**FH-CX75**  
**FH-RS505**  
WH-RX830  
WH-RX31 (QR)  
WH-U5000  
WH-RX010  
(O.L.D. 135 mm)

WH-R9170  
WH-R8170  
WH-RS710  
**WH-RS770**  
WH-RS370  
WH-RS171 (700c)  
**WH-RS171 (650b)**  
WH-RX870  
WH-RX570  
**WH-RX31 (E-THRU)**  
FH-RS770  
FH-R7070  
FH-RS470  
(O.L.D. 142 mm)



1x11-speed

METREA  
U5000

ST-U5060  
SL-U5000

RD-U5000-SS

CS-R9100  
CS-9000  
CS-6800  
CS-5800  
CS-R8000  
CS-HG800-11  
CS-R7000  
CS-HG700-11

GRX  
RX810  
RX600

ST-R9100  
ST-R9120  
ST-9001  
ST-9000  
SL-BSR1  
ST-R8000  
ST-R8020  
ST-R8025  
ST-6800  
ST-R7000  
ST-R7020  
ST-R7025  
ST-5800  
SL-RS700  
ST-RS685  
ST-RS505  
ST-U5060  
SL-U5000  
ST-RX810  
ST-RX600

RD-RX812  
(40T≤Largest  
sprocket≤42T)

CS-M8000-11  
CS-M7000-11  
CS-M5100-11

CN-9000  
CN-6800  
CN-HG901-11  
CN-HG701-11  
CN-HG601-11

CN-LG500

FH-9000  
WH-R9100  
WH-RS700  
WH-RS500  
WH-RS300  
WH-RS100  
FH-6800  
FH-5800  
FH-R7000  
FH-RS400  
(O.L.D. 130 mm)

FH-CX75  
FH-RS505  
WH-RX830  
WH-RX31 (QR)  
WH-U5000  
WH-RX010  
(O.L.D. 135 mm)

WH-R9170  
WH-R8170  
WH-RS710  
WH-RS770  
WH-RS370  
WH-RS171 (700c)  
WH-RS171 (650b)  
WH-RX870  
WH-RX570  
WH-RX31 (E-THRU)  
FH-RS770  
FH-R7070  
FH-RS470  
(O.L.D. 142 mm)

ST-R9150  
ST-R9160  
ST-R9170  
ST-R9180  
ST-9070  
ST-R8050  
ST-R8060  
ST-R8070  
ST-9071

RD-RX817  
(40T≤Largest  
sprocket≤42T)

ST-6870  
ST-6871  
ST-RX815  
ST-R785

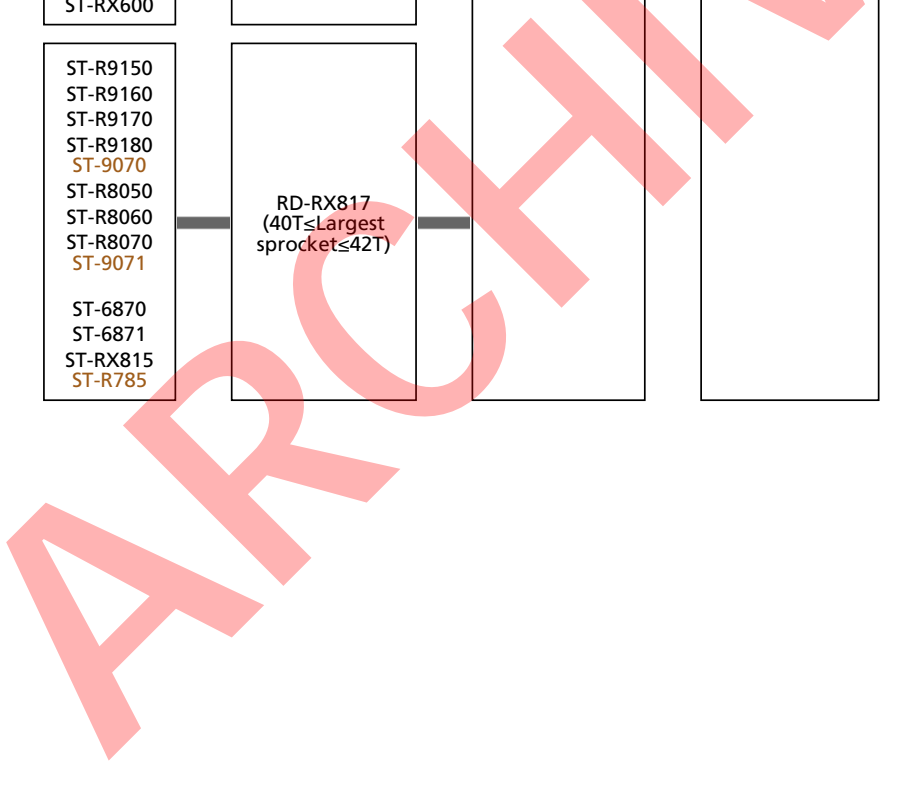



**2x10-speed**

**ULTEGRA  
6700**

**SHIMANO 105  
5700**

**TIAGRA  
4700  
4600**

**GRX  
RX400**

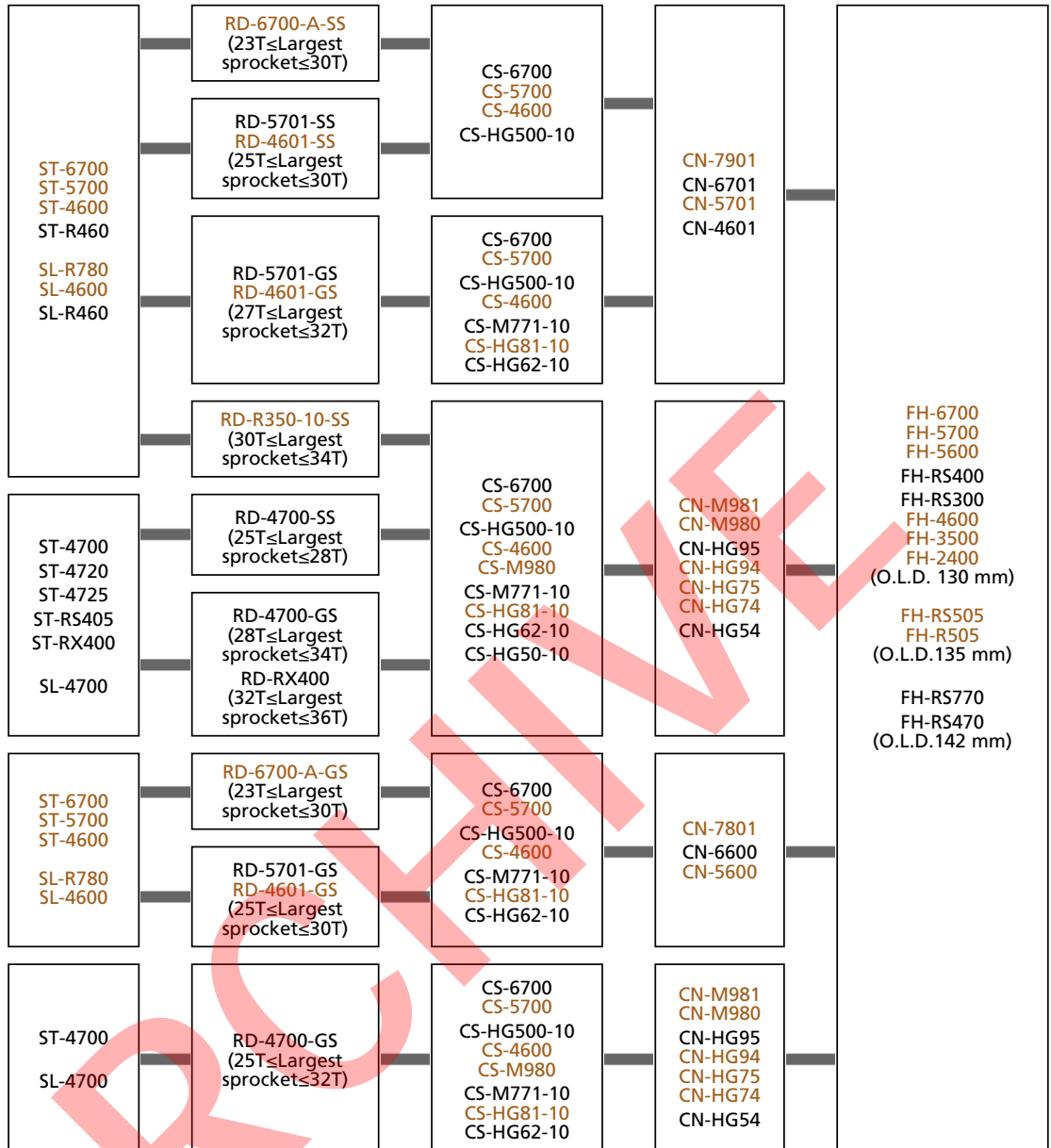

**3x10-speed**

**ULTEGRA  
6700**

**SHIMANO 105  
5700**

**TIAGRA  
4700  
4600**



**2x9-speed**

**SORA  
R3000  
3500**

ST-R3000  
ST-3500  
  
SL-R3000  
SL-3500

RD-R3000-SS  
RD-3500-SS  
(25T≤Largest  
sprocket≤32T)

RD-R3000-GS  
(28T≤Largest  
sprocket≤34T)  
RD-3500-GS  
(25T≤Largest  
sprocket≤32T)

CS-HG400-9  
CS-HG300-9  
CS-HG50-9  
CS-HG30-9  
CS-HG20-9

CN-7701  
CN-HG93  
CN-HG73  
CN-HG53

FH-6700  
FH-5700  
FH-5600  
FH-RS400  
FH-RS300  
FH-4600  
FH-3500  
FH-2400  
(O.L.D. 130 mm)  
  
FH-RS505  
FH-R505  
(O.L.D.135 mm)

**3x9-speed**

**SORA  
3500**

ST-R350  
SL-R350

RD-R350-GS  
(25T≤Largest  
sprocket≤32T)

**2x8-speed**

**CLARIS  
R2000  
2400**

ST-2400  
ST-R240  
ST-R2000  
ST-RS200  
  
SL-2400  
SL-R2000

RD-2400-SS  
RD-R2000-SS  
(25T≤Largest  
sprocket≤32T)

RD-R2000-GS  
(28T≤Largest  
sprocket≤34T)  
RD-2400-GS  
RD-R2000-SS  
(25T≤Largest  
sprocket≤32T)

CS-HG50-8

CN-HG91  
CN-HG71  
CN-HG50  
CN-HG40  
CN-UG51

**3x8-speed**

**CLARIS  
2400**

**2/3x8-speed**

**2300**

ST-2300

RD-2300  
(21T≤Largest  
sprocket≤26T)

**2/3x7-speed**

**TOURNEY  
A070  
A050**

ST-A070  
  
SL-A050-7R  
SL-SY20A

RD-A070  
  
RD-A050

CS-HG20-7(12-28T)  
CS-HG41-7(11-28T)

MF-TZ500-7-CP(14-28T)  
MF-TZ500-7(14-28T)  
MF-TZ510-7-CP(14-28T)  
MF-TZ510-7(14-28T)  
MF-TZ21(14-28T)  
MF-HG37(13-28T)

CN-HG71  
CN-HG50  
CN-HG40  
CN-UG51

FH-RM30-7  
FH-TY500-7-QR(130)  
FH-TY500-7-NT(130)  
(O.L.D. 130 mm)

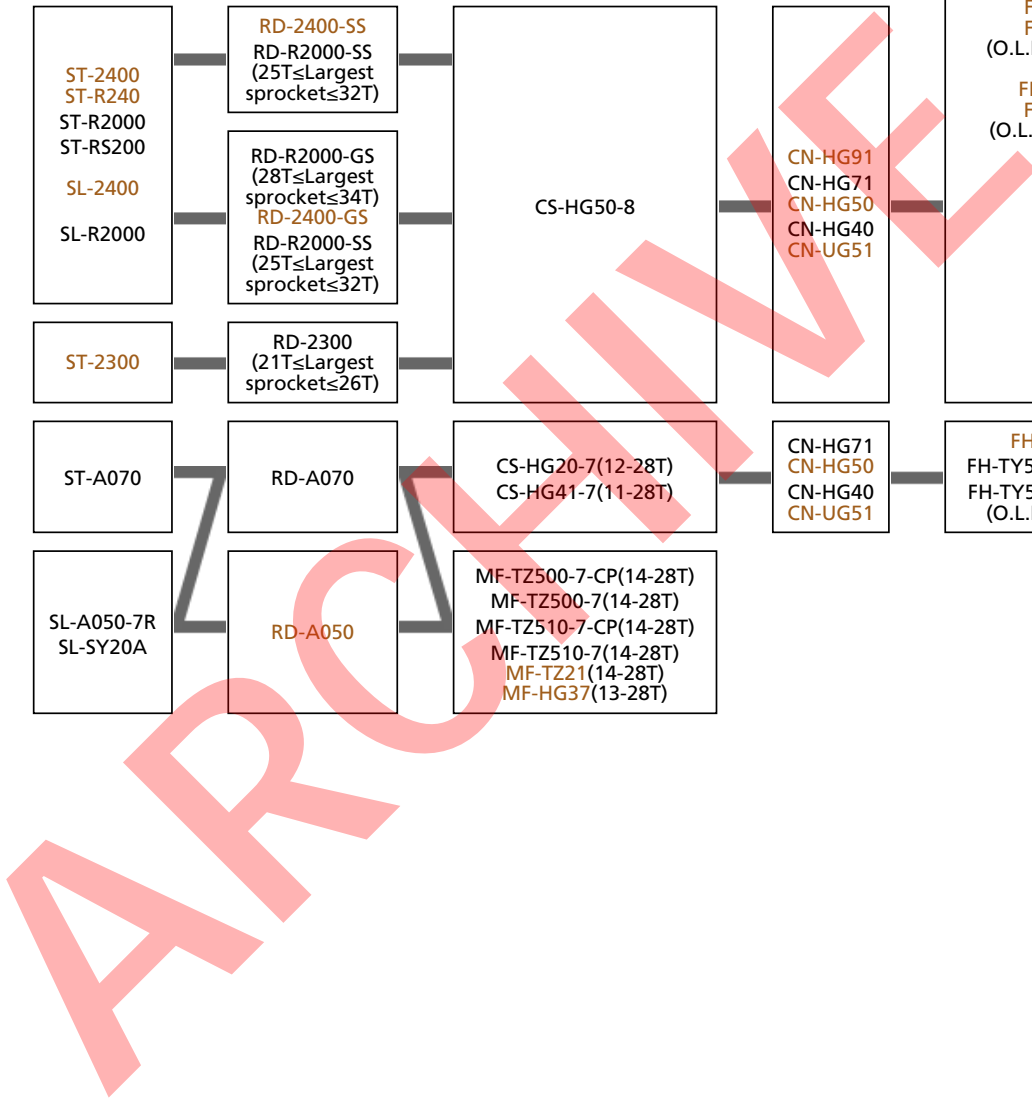

# Front drivetrain compatibility

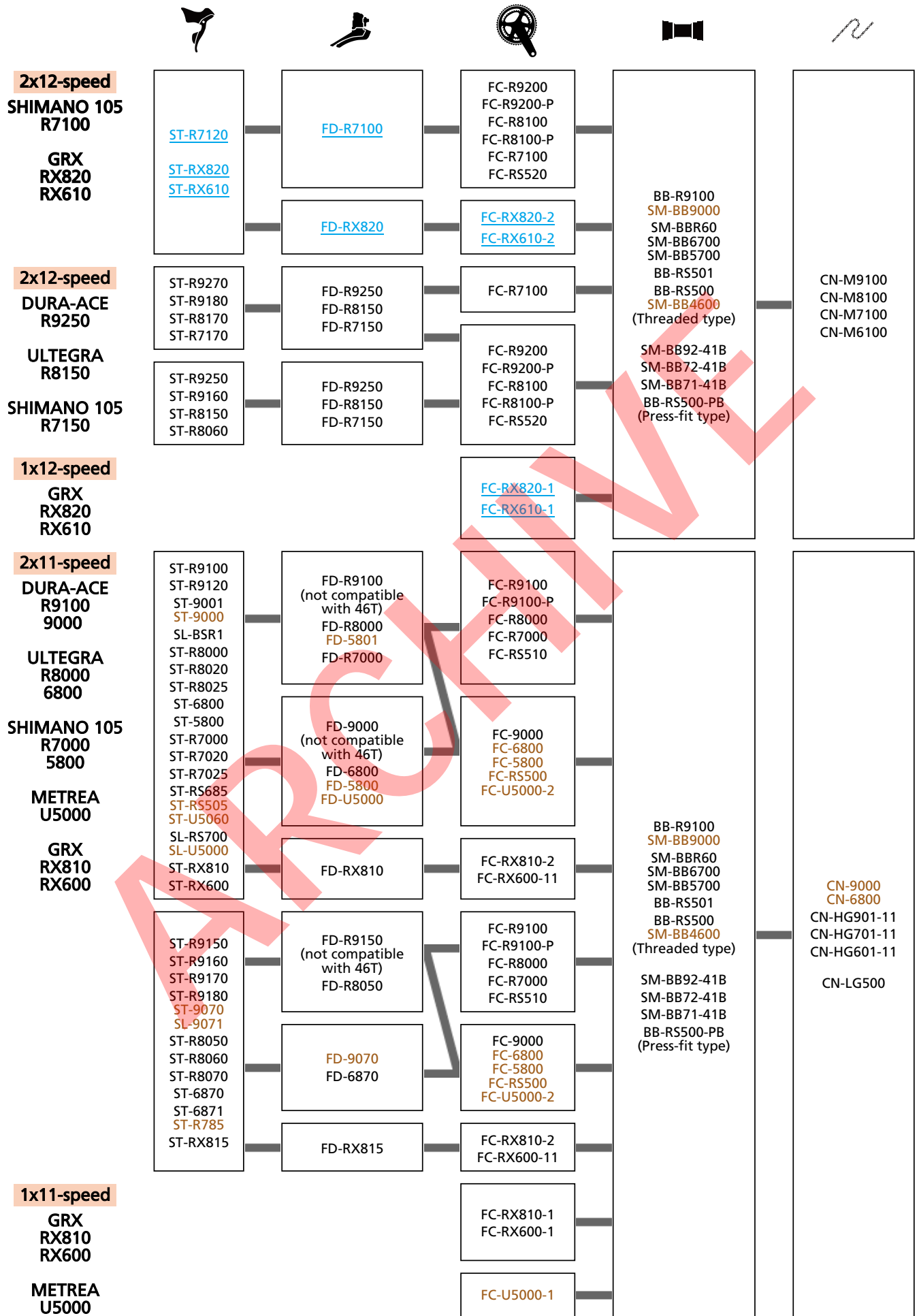



**2x10-speed**

**ULTEGRA  
6700**  
**SHIMANO 105  
5700**  
**TIAGRA  
4700  
4600**  
**GRX  
RX400**

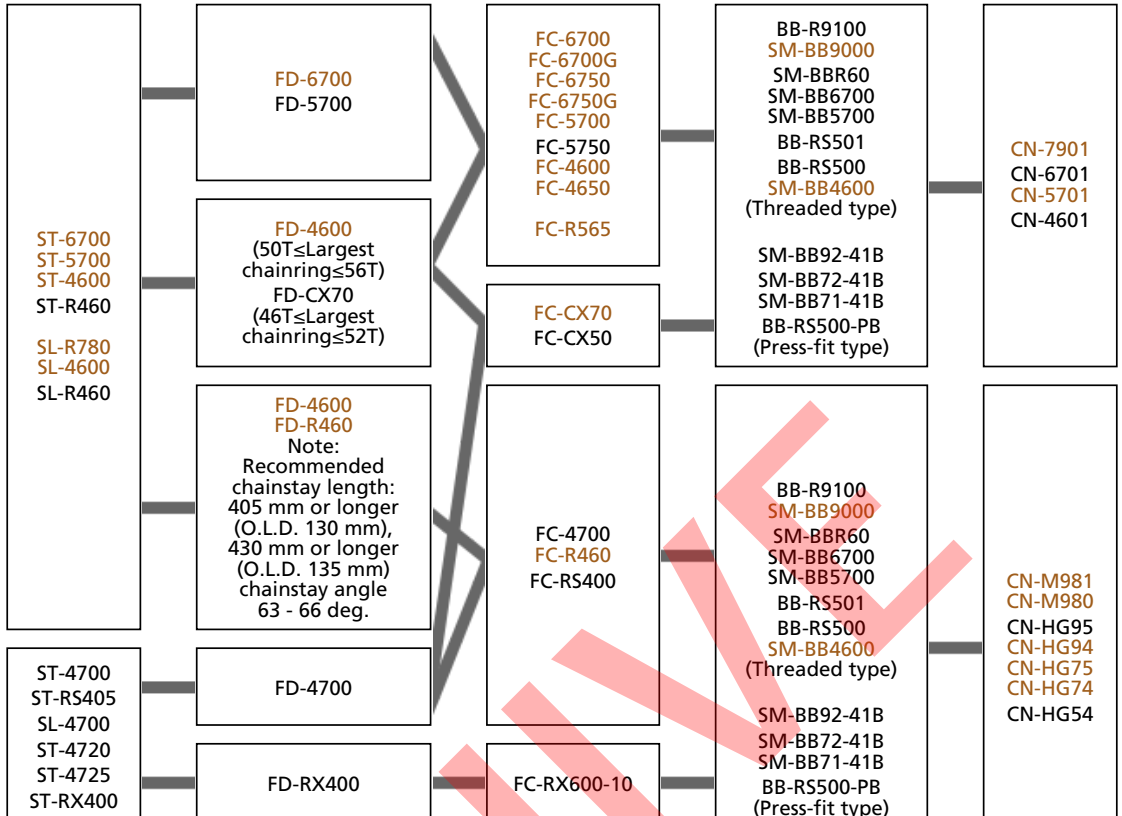

**3x10-speed**

**ULTEGRA  
6703**  
**SHIMANO 105  
5703**  
**TIAGRA  
4703  
4603**

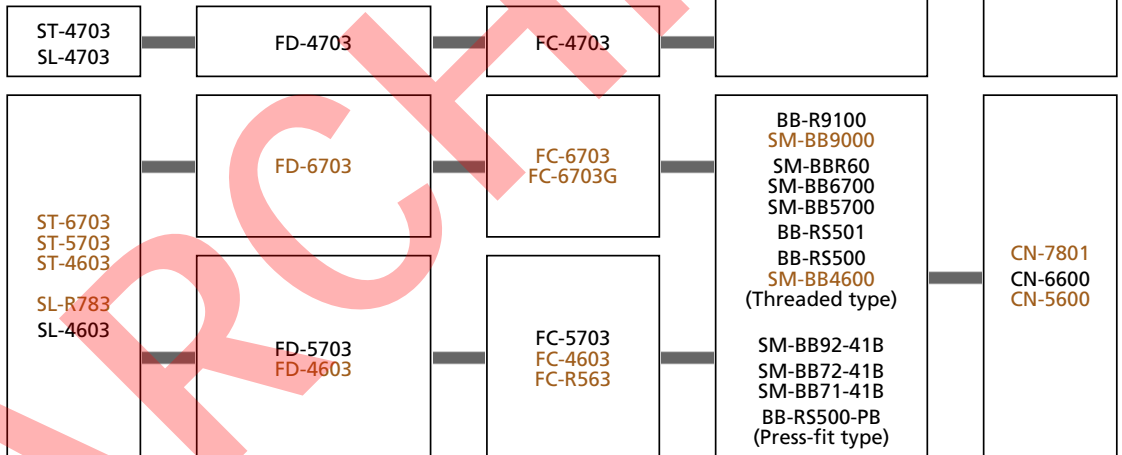

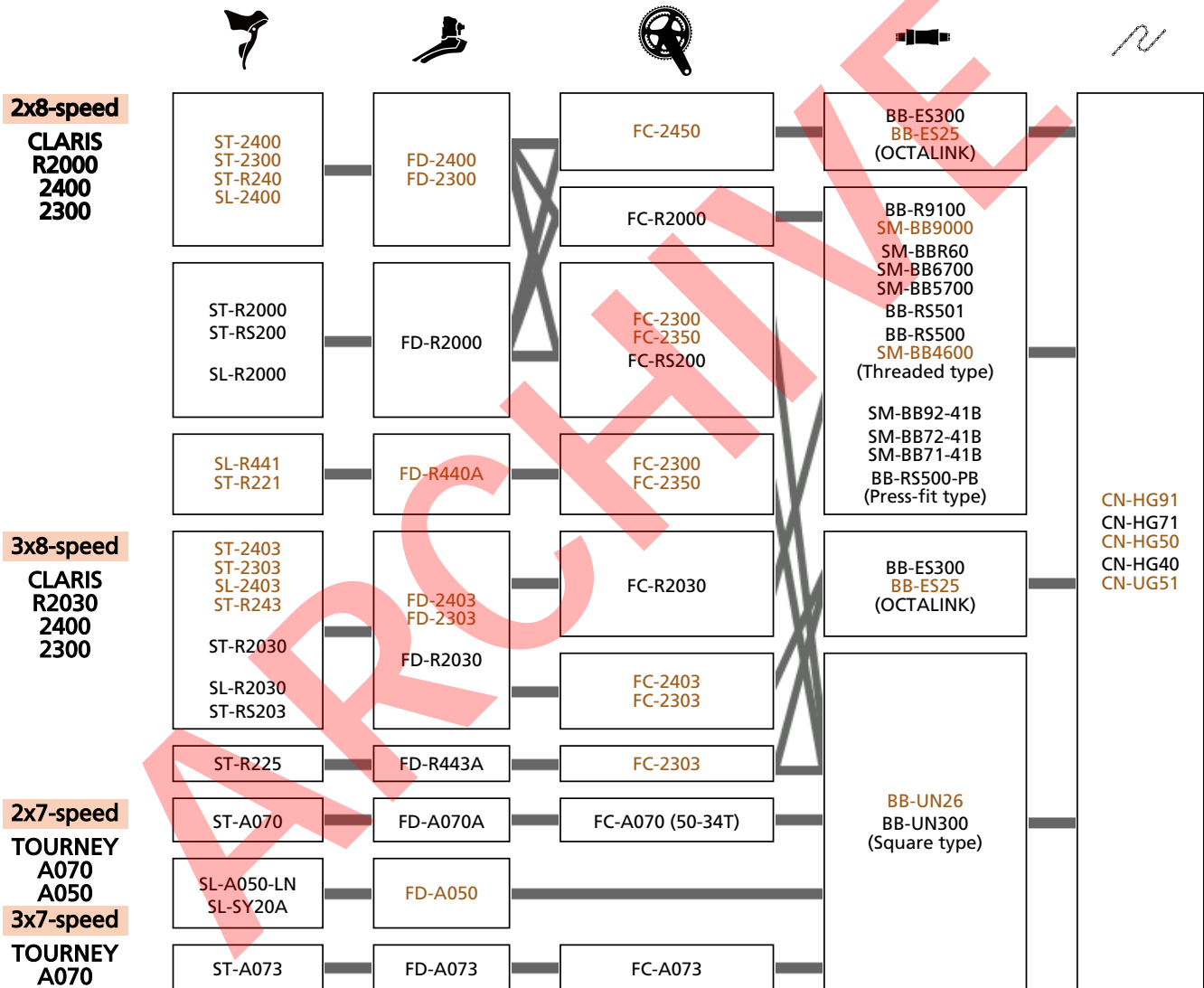
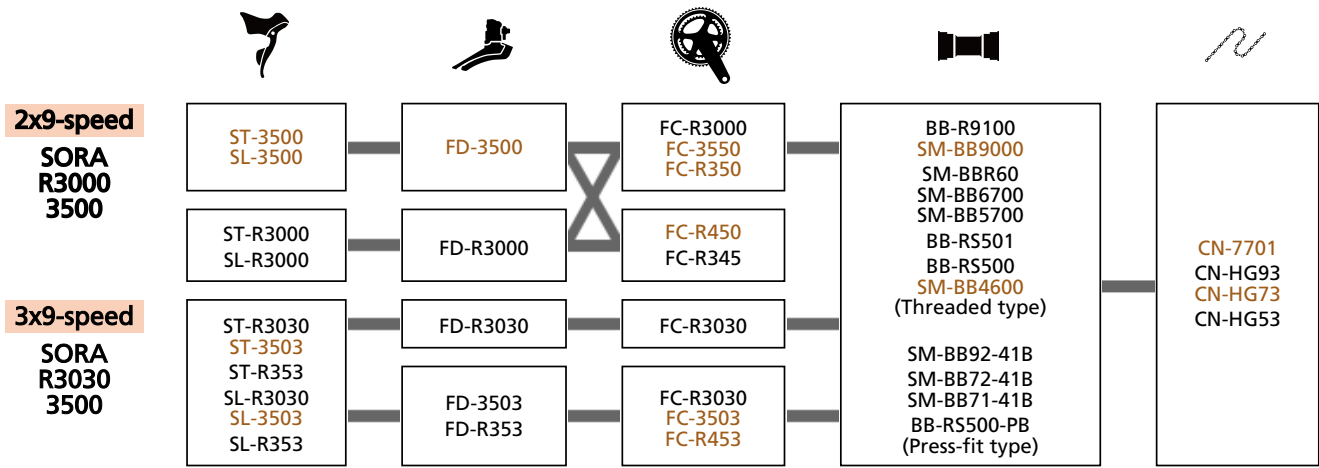



## Brake systems compatibility [ROAD]

C-456

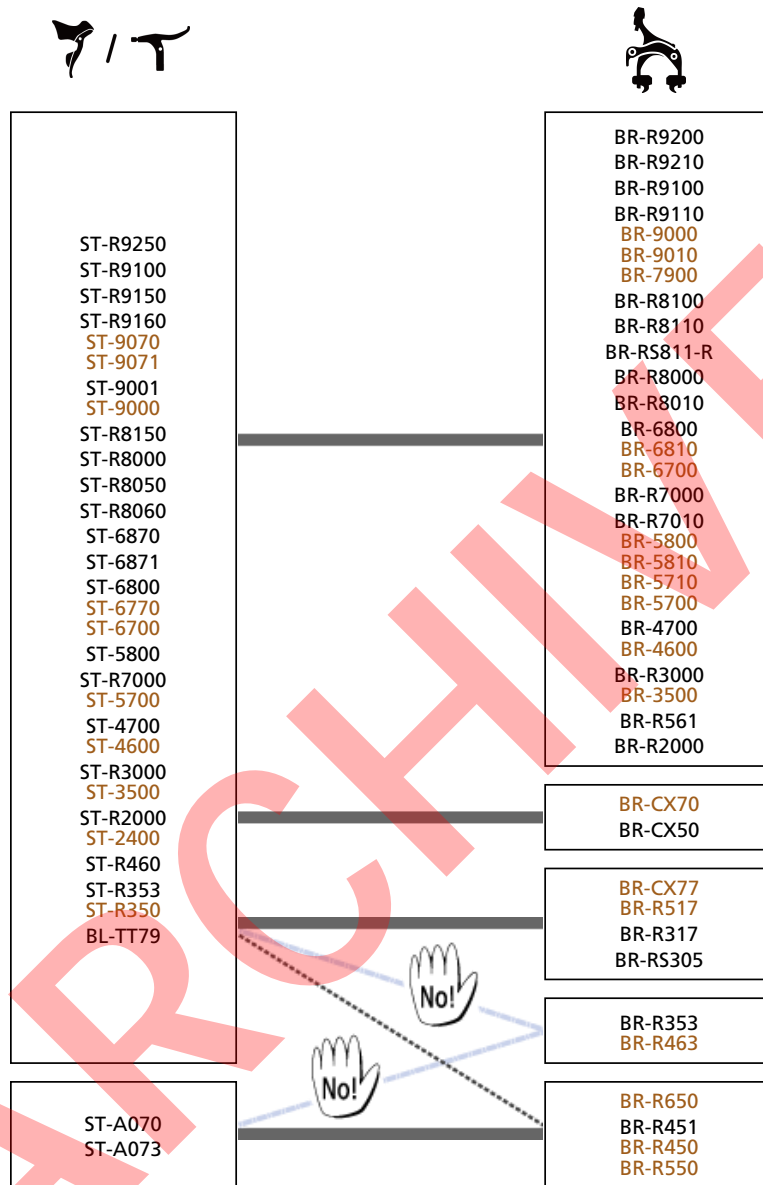

.....: Braking power is slightly less than standard combination.



: The "NO!" symbols indicate combinations that should not be used under any circumstances.

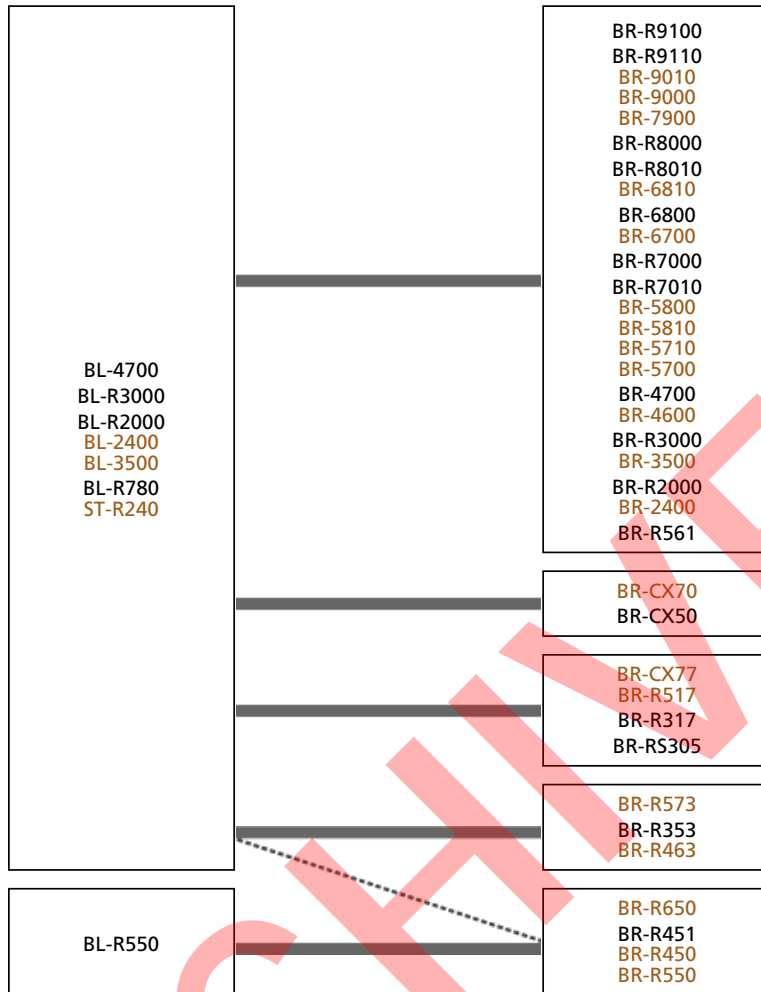

.....: Braking power is slightly less than standard combination.

ARCHIVE

# Hydraulic systems compatibility [ROAD, Gravel]

C-499

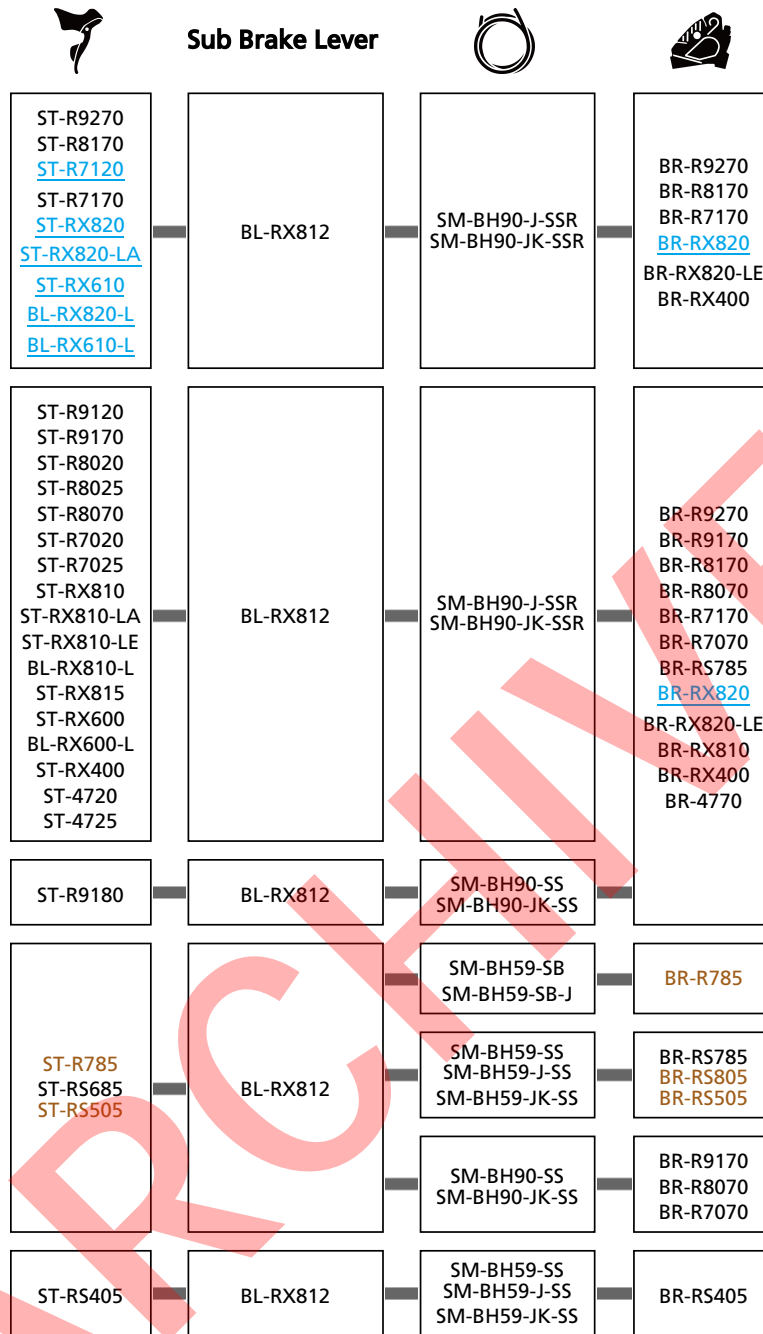

# Hydraulic systems compatibility [URBAN, LIFESTYLE]

C-500

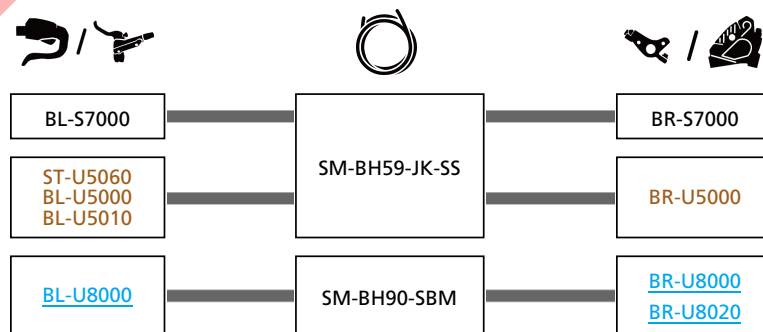

# Compatibility of [BL-U8000](#) with shift lever

## Shift levers compatible with [BL-U8000](#)

Series	Model No.
DEORE XT	SL-M8130-R
	SL-M8100-R
SLX	SL-M7100-R
DEORE	SL-M6100-R (w/o OPTICAL GEAR DISPLAY)
	SL-M5130-R (w/o OPTICAL GEAR DISPLAY)
	SL-M5100-R (w/o OPTICAL GEAR DISPLAY)
	SL-M4100-R (w/o OPTICAL GEAR DISPLAY)
SHIMANO CUES	<a href="#">SL-U8000-L</a> / <a href="#">SL-U8000-R</a>
	<a href="#">SL-U8000-IL</a> / <a href="#">SL-U8000-IR</a>

## [BL-U8000](#) compatibility with shift levers not listed in the table above

### Clamp band type

Shift lever type	Specification	Compatibility with <a href="#">BL-U8000</a>
REVOSHIFT	-	Not compatible
RAPIDFIRE PLUS RAPIDFIRE PLUS MONO Thumb Shifter PLUS	w/o OPTICAL GEAR DISPLAY	*1
	w/ OPTICAL GEAR DISPLAY on top *2	Not compatible
	w/ OPTICAL GEAR DISPLAY on bottom *2	*1

### I-SPEC type

Mount type	Compatibility
I-SPEC	Not compatible
I-SPEC II	*1
I-SPEC EV	Not compatible

\*1 Please contact SHIMANO sales office

\*2

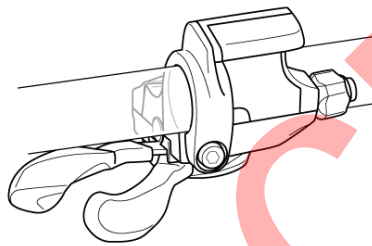

w/ OPTICAL GEAR DISPLAY on top

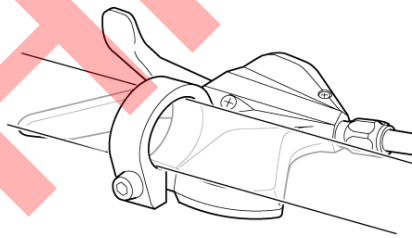

w/ OPTICAL GEAR DISPLAY on bottom

## Compatibility of I-SPEC shifter and brake lever

C-157

With the exceptions noted below, clamp band type shifters are compatible as I-SPEC if the upper body is replaced with an integral unit.

- RAPIDFIRE PLUS MONO Shifter
- SL-U8000

### I-SPEC EV shift lever

	Model No.	SL-M9100-I	SL-M8100-I	SL-M7100-I	SL-M6100-I	SL-M5100-I	SL-M4100-I	SL-M8130-I
I-SPEC EV	BL-M9100	✓	✓	✓	✓	✓	✓	✓
	BL-M9120	✓	✓	✓	✓	✓	✓	✓
	BL-M8100	✓	✓	✓	✓	✓	✓	✓
	BL-M7100	✓	✓	✓	✓	✓	✓	✓
	BL-M6100	✓	✓	✓	✓	✓	✓	✓
	BL-M4100	✓	✓	✓	✓	✓	✓	✓
I-SPEC II	BL-M9000	-	-	-	-	-	-	-
	BL-M9020	-	-	-	-	-	-	-
	BL-M8000	-	-	-	-	-	-	-
	BL-T8100	-	-	-	-	-	-	-
	BL-T8000	-	-	-	-	-	-	-
	BL-M7000	-	-	-	-	-	-	-
	BL-M6000	-	-	-	-	-	-	-
	BL-T6000	-	-	-	-	-	-	-
	BL-RS600	-	-	-	-	-	-	-
	BL-MT500	-	-	-	-	-	-	-
	BL-MT501	-	-	-	-	-	-	-
	BL-U8000 *1	-	-	-	-	-	-	-
	BL-U5000	-	-	-	-	-	-	-
I-SPEC B	BL-M820-B	-	-	-	-	-	-	-

\*1: As for the compatibility between [BL-U8000](#) and mechanical shift lever, please refer to the [C-738](#).

### I-SPEC II shift lever

	Model No.	SL-M9000-I	SL-M8000-I	SL-M7000-11-I SL-M7000-10-I	SL-U5000	SL-M6000-I	SL-RS700-I	<a href="#">SL-U8000-I</a>
I-SPEC EV	BL-M9100	-	-	-	-	-	-	-
	BL-M9120	-	-	-	-	-	-	-
	BL-M8100	-	-	-	-	-	-	-
	BL-M7100	-	-	-	-	-	-	-
	BL-M6100	-	-	-	-	-	-	-
	BL-M4100	-	-	-	-	-	-	-
I-SPEC II	BL-M9000	✓	✓	✓	✓	✓	✓	✓
	BL-M9020	✓	✓	✓	✓	✓	✓	✓
	BL-M8000	✓	✓	✓	✓	✓	✓	✓
	BL-T8100	✓	✓	✓	✓	✓	✓	✓
	BL-T8000	✓	✓	✓	✓	✓	✓	✓
	BL-M7000	✓	✓	✓	✓	✓	✓	✓
	BL-M6000	✓	✓	✓	✓	✓	✓	✓
	BL-T6000	✓	✓	✓	✓	✓	✓	✓
	BL-RS600	✓	✓	✓	✓	✓	✓	✓
	BL-MT500	✓	✓	✓	✓	✓	✓	✓
	BL-MT501	✓	✓	✓	✓	✓	✓	✓
	BL-U8000 *1	-	-	-	-	-	-	✓
	BL-U5000	✓	✓	✓	✓	✓	✓	✓
I-SPEC B	BL-M820-B	-	-	-	-	-	-	-

\*1: As for the compatibility between [BL-U8000](#) and mechanical shift lever, please refer to the [C-738](#).

## I-SPEC B shift lever

	Model No.	SL-M8000-B-I	SL-M7000-11 SL-M7000-10-B-I	SL-M820-B-I SL-M820 (with SM-SL82-B)
I-SPEC EV	BL-M9100	-	-	-
	BL-M9120	-	-	-
	BL-M8100	-	-	-
	BL-M7100	-	-	-
	BL-M6100	-	-	-
	BL-M4100	-	-	-
I-SPEC II	BL-M9000	-	-	-
	BL-M9020	-	-	-
	BL-M8000	-	-	-
	BL-T8100	-	-	-
	BL-T8000	-	-	-
	BL-M7000	-	-	-
	BL-M6000	-	-	-
	BL-T6000	-	-	-
	BL-RS600	-	-	-
	BL-MT500	-	-	-
	BL-MT501	-	-	-
BL-U8000 *1	-	-	-	
BL-U5000	-	-	-	
I-SPEC B	BL-M820-B	✓	✓	✓

\*1: As for the compatibility between [BL-U8000](#) and mechanical shift lever, please refer to the [C-738](#).

## Compatibility of seat post lever and brake lever

	Model No.	I-SPEC EV shift lever	
		SL-MT800	SL-MT500-I
I-SPEC EV	BL-M9100	✓	✓
	BL-M9120	✓	✓
	BL-M8100	✓	✓
	BL-M7100	✓	✓
	BL-M6100	✓	✓
	BL-M4100	✓	✓
I-SPEC II	BL-M9000	-	-
	BL-M9020	-	-
	BL-M8000	-	-
	BL-T8100	-	-
	BL-T8000	-	-
	BL-M7000	-	-
	BL-M6000	-	-
	BL-T6000	-	-
	BL-RS600	-	-
	BL-MT500	-	-
	BL-MT501	-	-
BL-U8000	-	-	
BL-U5000	-	-	
I-SPEC B	BL-M820-B	-	-

## Disc brake caliper and disc brake rotor compatibility

C-461

Brake caliper	Brake pad material	Pad type	Disc brake rotor				
			220 mm (LL)	203 mm (L)	180 mm (M)	160 mm (S)	140 mm (SS)
BR-M9100*4 BR-M9110*5 BR-M9120 BR-M8100 BR-M8110*6 BR-M8120 BR-M8000 BR-M8020 BR-M7100 BR-M7110*6 BR-M7120 BR-M6100 BR-M6120 BR-MT520 BR-MT420 BR-M820 <a href="#">BR-U8000</a> <a href="#">BR-U8020</a>	Metal / Resin	Narrow	SM-RT66-LL SM-RT64-LL	<a href="#">RT-CL900-203</a> <a href="#">RT-CL800-203</a> RT-MT905-L RT-MT900-L <a href="#">SM-RT99-L</a> RT-MT800-L SM-RT86-L <a href="#">SM-RT81-L</a> SM-RT76-L SM-RT70-L SM-RT66-L SM-RT64-L SM-RT30-L*2 RT-EM910-L*1 <a href="#">RT-EM900-L*1</a> RT-EM810-L*1 RT-EM600-L*1 RT-EM300-L*1*2	<a href="#">RT-CL900-180</a> <a href="#">RT-CL800-180</a> RT-MT905-M RT-MT900-M <a href="#">SM-RT99-M</a> RT-MT800-M SM-RT86-M <a href="#">SM-RT81-M</a> SM-RT76-M SM-RT70-M SM-RT66-M SM-RT64-M SM-RT56-M*2 SM-RT54-M*2 SM-RT30-M*2 SM-RT26-M*2 SM-RT10-M*2 RT-EM910-M*1 <a href="#">RT-EM900-M*1</a> RT-EM810-M*1 <a href="#">RT-EM800-M*1</a> RT-EM600-M*1 RT-EM300-M*1*2	RT-CL900-160 RT-CL800-160 RT-MT900-S SM-RT900-S SM-RT800-S <a href="#">SM-RT99-S</a> RT-MT800-S SM-RT86-S <a href="#">SM-RT81-S</a> SM-RT76-S SM-RT70-S SM-RT66-S SM-RT64-S SM-RTC60 SM-RT56-S*2 SM-RT54-S*2 SM-RT30-S*2 SM-RT26-S*2 SM-RT10-S*2 RT-EM910-M*1 <a href="#">RT-EM900-S*1</a> RT-EM810-M*1 RT-EM810-M*1 <a href="#">RT-EM800-S*1</a> RT-EM600-S*1 RT-EM300-S*1*2	RT-CL900-140 RT-CL800-140 RT-MT900-SS SM-RT900-SS SM-RT99-SS <a href="#">SM-RT99-A-SS</a> RT-MT800-SS SM-RT800-SS <a href="#">SM-RT81-SS</a> SM-RT70-SS
<a href="#">BR-S700</a> BR-S7000	Resin	-	-	-	-	-	-
BR-MT410	Resin	Wide	-	SM-RT30-L RT-EM300-L*1	-	-	-
<a href="#">BR-T675</a> <a href="#">BR-T615</a> <a href="#">BR-M4050</a> BR-MT500 <a href="#">BR-M446</a> BR-MT400 <a href="#">BR-M3050</a> <a href="#">BR-M395</a> BR-M375 BR-MT200 <a href="#">BR-M365</a> <a href="#">BR-M315</a> BR-TX805 BR-UR300	Resin	Wide	-	-	SM-RT56-M SM-RT54-M SM-RT30-M SM-RT26-M SM-RT10-M RT-EM300-M*1	SM-RT56-S SM-RT54-S SM-RT30-S SM-RT26-S SM-RT10-S RT-EM300-S*1	-
BR-R9270*7 BR-R9170*3 BR-R8170 BR-R8070 BR-R7170 BR-R7070 BR-4770 <a href="#">BR-R5805</a> <a href="#">BR-R785</a> BR-R5785 <a href="#">BR-R5505</a> BR-R5405 BR-R5305 <a href="#">BR-RX820</a> BR-RX820-LE BR-RX810 BR-RX400	Metal / Resin	Narrow	-	-	<a href="#">RT-CL900-180</a> <a href="#">RT-CL800-180</a> RT-MT905-M RT-MT900-M RT-MT800-M <a href="#">SM-RT99-M</a> SM-RT86-M <a href="#">SM-RT81-M</a> SM-RT76-M SM-RT70-M SM-RT66-M SM-RT64-M SM-RT56-M*2 SM-RT54-M*2 SM-RT30-M*2 SM-RT26-M*2 SM-RT10-M*2 RT-EM910-M*1 <a href="#">RT-EM900-M*1</a> RT-EM810-M*1 <a href="#">RT-EM800-M*1</a> RT-EM600-M*1 RT-EM300-M*1*2	RT-CL900-160 RT-CL800-160 RT-MT900-S SM-RT900-S RT-MT800-S SM-RT800-S <a href="#">SM-RT99-S</a> SM-RT86-S <a href="#">SM-RT81-S</a> SM-RT76-S SM-RT70-S SM-RT66-S SM-RT64-S SM-RT56-S*2 SM-RT54-S*2 SM-RT30-S*2 SM-RT26-S*2 SM-RT10-S*2 RT-EM910-S*1 <a href="#">RT-EM900-S*1</a> RT-EM810-S*1 <a href="#">RT-EM800-S*1</a> RT-EM600-S*1 RT-EM300-S*1*2	RT-CL900-140 RT-CL800-140 RT-MT900-SS SM-RT900-SS SM-RT99-SS <a href="#">SM-RT99-A-SS</a> SM-RT81-SS SM-RT70-SS SM-RT64-SS
<a href="#">BR-CX77</a> BR-R517 BR-R317	Metal / Resin	Narrow	-	-	-	<a href="#">SM-RT99-S</a> SM-RT86-S <a href="#">SM-RT81-S</a> SM-RT76-S SM-RT70-S SM-RT66-S SM-RT64-S	<a href="#">SM-RT99-SS</a> <a href="#">SM-RT99-A-SS</a> <a href="#">SM-RT81-SS</a>
BR-U5000*3	Metal / Resin	Narrow	-	-	-	<a href="#">SM-RT99-S</a> SM-RT86-S <a href="#">SM-RT81-S</a> SM-RT76-S SM-RT70-S SM-RT66-S SM-RT64-S	<a href="#">SM-RT500-SS</a> <a href="#">SM-RT99-SS</a> <a href="#">SM-RT99-A-SS</a> <a href="#">SM-RT81-SS</a>

- \*1 Disc brake rotor for speed sensor SM-DUE11, rear only
- \*2 Resin pad only
- \*3 Not compatible with rear 180 mm (M) disc brake rotors
- \*4 Not compatible with 220mm (LL) and 203 mm (L) disc brake rotors
- \*5 For rear only. Not compatible with 220mm (LL), 203 mm (L) and 180 mm (M) disc brake rotors.
- \*6 For rear only. Not compatible 220mm (LL) and with 203 mm (L) disc brake rotors.
- \*7 Not compatible with 180 mm (M) disc brake rotors.

Wide type disc brake rotor

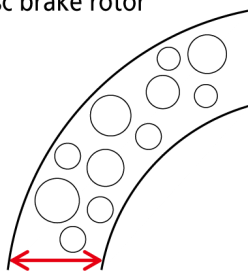

Narrow type disc brake rotor

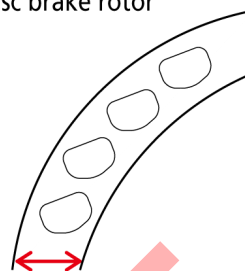

#### NOTE

- SM-RT56 / SM-RT54 / SM-RT30 / SM-RT26 / SM-RT10 / RT-EM300 are compatible with Resin pad caliper specification only. If use with metal pads, disc brake rotor will be easily damaged.
- When using 140 mm disc brake rotor, braking power is less than 160 mm, please confirm the power is enough for your purpose. 140 mm disc brake rotor is recommended for rear use only.
- Narrow type 2 piece disc brake rotors are not compatible to brake caliper for Wide type disc brake rotor because of interference.
- BR-UR300 doesn't need front mount bracket and rear adapter.



# Compatibility of lock ring with hubs

C-612

## Front hub (Disc Brake)

Type	Fixing type of lock ring		
	Internal spline	both Internal & external spline	External spline
QR type	✓	✓	✓
12 mm E-THRU type	✓	✓*	✓
15 mm E-THRU type	-	✓*	✓
20 mm thru axle type	-	✓*	✓

\* For E-THRU hub, "Internal & external spline" type lock ring can not be install by TL-LR11. Please Tighten with TL-FC36.

## FREEHUB (Disc Brake)

Model No.	Fixing type of lock ring		
	Internal spline	Internal & external spline	External spline
FH-M9111 FH-M9111-B FH-M9111-BS FH-M9000 FH-M9010 FH-M9010-B FH-MT901-B FH-MT901-BS	-	-	✓
Other models (MTB, Trekking, ROAD, URBAN)	✓	✓	✓

# Compatibility between brake systems (MT400 series)

C-606

	BR-MT400	BR-MT420
BL-MT400	✓	-
BL-MT402-3A	✓	✓
BL-MT401-3A	✓	-
BL-MT401	✓	✓

# Combination chart (mechanical disc brake)

C-462

## Mechanical disc brake combination chart C-463

In order to realize the best performance, we recommend that the following combination be used.

Model No.	Mount type	Brake lever
BR-M375 BR-TX805	*	V-BRAKE BL (2 finger)
BR-R517	*	Road lever**
BR-R317	*	Road lever**
BR-CX77	*	Road lever**
BR-RS305	FLAT MOUNT	Road lever**

\* Front mount: International standard / Post mount, Rear mount: International standard / Post mount

\*\* For BL-R780 / 4600 / 5700

## Mechanical disc brake and brake lever compatibility C-464

Model No.	Brake lever type		
	2 finger	3,4 finger	3,4 finger w/ POWER MODULATOR* w/ SM-PM50
BR-M375	✓	-	✓
BR-TX805	✓	-	✓

\* POWER MODULATOR must be used for front brake

# Compatibility between hydraulic disc brake hose

## MTB / Trekking / URBAN / LIFESTYLE C-732

Connection		SM-BH90-JK-SSR	SM-BH90-SBM	SM-BH90-SBLS	SM-BH90-SBS	SM-BH90-SB	SM-BH90-SS
Rigidity		Straight - Straight	Straight - Banjo	Straight - Banjo	Straight - Banjo	Straight - Banjo	Straight - Straight
		High power	High power	High power	High power	High power	High power
BL-M9100	BR-M9100	-	-	-	-	-	✓
BL-M9100	BR-M9110	-	-	-	-	-	✓
BL-M9120	BR-M9120	-	✓	-	-	-	-
BL-M9000	BR-M9000	-	✓	-	-	-	-
BL-M9020	BR-M9020	-	✓	-	-	✓	-
BL-M820	BR-M820	-	-	✓	-	-	-
BL-M8100	BR-M8100	-	✓	-	-	-	-
BL-M8100	BR-M8110	-	-	-	-	-	✓
BL-M8100	BR-M8120	-	✓	-	-	-	-
BL-M8000	BR-M8000	-	✓	-	-	✓	-
BL-M8000	BR-M8020	-	-	✓	-	-	-
BL-T8100	BR-M8100	-	✓	-	-	-	-
BL-T8100	BR-M8120	-	✓	-	-	-	-
BL-M7100	BR-M7100	-	✓	-	-	-	-
BL-M7100	BR-M7110	-	-	-	-	-	✓
BL-M7100	BR-M7120	-	✓	-	-	-	-
BL-M7000	BR-M7000	-	✓	-	-	✓	-
BL-M6100	BR-M6100	-	-	-	-	-	✓
BL-M6100	BR-M6120	-	-	-	-	-	✓
BL-T675	BR-T675	-	-	-	-	-	✓
BL-M640	BR-M640	-	-	✓	✓	-	-
BL-M6000	BR-M6000	-	-	-	-	-	✓
BL-M4100	BR-MT410	-	-	-	-	-	-
BL-M4100	BR-MT420	-	-	-	-	-	✓
BL-T6000	BR-M6000	-	-	-	-	-	-
BL-S7000	BR-S7000	-	-	-	-	-	-
BL-MT501	BR-MT520	-	-	-	-	-	✓
BL-MT501	BR-MT500	-	-	-	-	-	-
BL-MT500	BR-MT500	-	-	-	-	-	-
ST-M4050	BR-M4050	-	-	-	-	-	-
ST-M3050	BR-M3050	-	-	-	-	-	-
BL-T445	BR-M446	-	-	-	-	-	-
BL-MT400	BR-MT400	-	-	-	-	-	-
BL-MT401	BR-MT400	-	-	-	-	-	-
BL-MT401	BR-MT420	-	-	-	-	-	✓
BL-MT401-3A	BR-MT400	-	-	-	-	-	-
BL-MT402-3A	BR-MT400	-	-	-	-	-	-
BL-MT402-3A	BR-MT420	-	-	-	-	-	✓
BL-M425	BR-M395	-	-	-	-	-	-
BL-M396	BR-M395	-	-	-	-	-	-
BL-MT201	BR-MT200	-	-	-	-	-	-
BL-MT200	BR-MT200	-	-	-	-	-	-
BL-MT201	BR-UR300	-	-	-	-	-	-
BL-MT200	BR-UR300	-	-	-	-	-	-
BL-M365	BR-M365	-	-	-	-	-	-
BL-M315	BR-M315	-	-	-	-	-	-
ST-EF505	BR-M315	-	-	-	-	-	-
ST-EF505	BR-MT200	-	-	-	-	-	-
BL-S700	BR-S700	-	✓	-	-	✓	-
BL-U8000	BR-U8000	-	✓	-	-	-	-
BL-U8000	BR-U8020	-	✓	-	-	-	-
BL-U5000		-	-	-	-	-	-
BL-U5010	BR-U5000	-	-	-	-	-	-
ST-U5060		-	-	-	-	-	-

Level of compatibility

✓: Compatible

\*: Refer to manual of SM-BH80, SM-BH59 (brake hose 10 m coil) for assembling / disassembling banjo unit

-: Impossible to use

		SM-BH59-J-SS	SM-BH59-JK-SS (MTB)	SM-BH59-JK-SS (ROAD)	SM-BH59-SB	SM-BH59-SB-J
Connection		Straight - Straight	Straight - Straight	Straight - Straight	Straight - Banjo	Straight - Banjo
Rigidity		Standard	Standard	Standard	Standard	Standard
BL-M9100	BR-M9100	-	-	-	-	-
BL-M9100	BR-M9110	-	-	-	-	-
BL-M9120	BR-M9120	-	-	-	-	-
BL-M9000	BR-M9000	-	-	-	-	-
BL-M9020	BR-M9020	-	-	-	-	-
BL-M820	BR-M820	-	-	-	-	-
BL-M8100	BR-M8100	-	-	-	-	-
BL-M8100	BR-M8110	-	-	-	-	-
BL-M8100	BR-M8120	-	-	-	-	-
BL-M8000	BR-M8000	-	-	-	-	-
BL-M8000	BR-M8020	-	-	-	-	-
BL-T8100	BR-M8100	-	-	-	-	-
BL-T8100	BR-M8120	-	-	-	-	-
BL-M7100	BR-M7100	-	-	-	-	-
BL-M7100	BR-M7110	-	-	-	-	-
BL-M7100	BR-M7120	-	-	-	-	-
BL-M7000	BR-M7000	-	-	-	-	-
BL-M6100	BR-M6100	-	-	-	-	-
BL-M6100	BR-M6120	-	-	-	-	-
BL-T675	BR-T675	-	-	-	-	-
BL-M640	BR-M640	-	-	-	-	-
BL-M6000	BR-M6000	-	-	-	-	-
BL-M4100	BR-MT410	-	✓	-	-	-
BL-M4100	BR-MT420	-	-	-	-	-
BL-T6000	BR-M6000	-	✓	-	-	-
BL-S7000	BR-S7000	-	✓	-	-	-
BL-MT501	BR-MT520	-	-	-	-	-
BL-MT501	BR-MT500	-	✓	-	-	-
BL-MT500	BR-MT500	-	✓	-	-	-
ST-M4050	BR-M4050	-	✓	-	-	-
ST-M3050	BR-M3050	-	✓	-	-	-
BL-T445	BR-M446	-	✓	-	-	-
BL-MT400	BR-MT400	-	✓	-	-	-
BL-MT401	BR-MT400	-	✓	-	-	-
BL-MT401	BR-MT420	-	-	-	-	-
BL-MT401-3A	BR-MT400	-	✓	-	-	-
BL-MT402-3A	BR-MT400	-	✓	-	-	-
BL-MT402-3A	BR-MT420	-	-	-	-	-
BL-M425	BR-M395	-	✓	-	-	-
BL-M396		-	-	-	-	-
BL-MT201	BR-MT200	-	✓	-	-	-
BL-MT200	BR-MT200	-	✓	-	-	-
BL-MT201	BR-UR300	-	✓	-	-	-
BL-MT200	BR-UR300	-	✓	-	-	-
BL-M365	BR-M365	-	✓	-	-	-
BL-M315	BR-M315	-	✓	-	-	-
ST-EF505	BR-M315	-	✓	-	-	-
ST-EF505	BR-MT200	-	✓	-	-	-
BL-S700	BR-S700	-	-	-	-	-
BL-U8000	BR-U8000	-	-	-	-	-
BL-U8000	BR-U8020	-	-	-	-	-
BL-U5000		-	-	✓	-	-
BL-U5010	BR-U5000	-	-	✓	-	-
ST-U5060		-	-	✓	-	-

Level of compatibility

✓: Compatible

\*: Refer to manual of SM-BH80, SM-BH59 (brake hose 10 m coil) for assembling / disassembling banjo unit

-: Impossible to use

# ROAD / Gravel C-733

Connection		SM-BH90-JK-SSR	SM-BH90-SBM	SM-BH90-SBLS	SM-BH90-SBS	SM-BH90-SB	SM-BH90-SS
Rigidity		Straight - Straight	Straight - Banjo	Straight - Banjo	Straight - Banjo	Straight - Banjo	Straight - Straight
		High power	High power	High power	High power	High power	High power
ST-R9270	BR-R9270	✓	-	-	-	-	-
ST-R9120	BR-R9170	✓	-	-	-	-	-
ST-R9170	BR-R9170	✓	-	-	-	-	-
ST-R9180	BR-R9170	✓	-	-	-	-	-
ST-R8170	BR-R8170	✓	-	-	-	-	-
ST-R8020	BR-R8070	✓	-	-	-	-	-
ST-R8070	BR-R8070	✓	-	-	-	-	-
<a href="#">ST-R7120</a>	BR-R7170	✓	-	-	-	-	-
ST-R7170	BR-R7170	✓	-	-	-	-	-
ST-R7020	BR-R7070	✓	-	-	-	-	-
ST-R7025	BR-R7070	✓	-	-	-	-	-
ST-R785	BR-RS805	-	-	-	-	-	-
ST-R785	BR-RS785	-	-	-	-	-	-
ST-R785	BR-R785	-	-	-	-	-	-
ST-RS685	BR-RS805	-	-	-	-	-	-
ST-RS685	BR-RS785	-	-	-	-	-	-
ST-RS685	BR-R785	-	-	-	-	-	-
ST-RS505	BR-RS785	-	-	-	-	-	-
ST-RS505	BR-RS505	-	-	-	-	-	-
ST-RS405	BR-RS405	-	-	-	-	-	-
BL-RS600	BR-RS405	-	-	-	-	-	-
<a href="#">ST-RX820</a>	<a href="#">BR-RX820</a>	✓	-	-	-	-	-
ST-RX815	BR-RX810	✓	-	-	-	-	-
ST-RX810-LE	BR-RX820-LE	✓	-	-	-	-	-
BL-T8100-LE	BR-RX820-LE	-	-	-	-	-	✓
ST-RX810	BR-RX810	✓	-	-	-	-	-
<a href="#">BL-RX820</a>	<a href="#">BR-RX820</a>	✓	-	-	-	-	-
BL-RX810	BR-RX810	✓	-	-	-	-	-
<a href="#">ST-RX610</a>	BR-RX400	✓	-	-	-	-	-
ST-RX600	BR-RX400	✓	-	-	-	-	-
<a href="#">BL-RX610</a>	BR-RX400	✓	-	-	-	-	-
BL-RX600	BR-RX400	✓	-	-	-	-	-
ST-RX400	BR-RX400	✓	-	-	-	-	-

Level of compatibility

✓: Compatible

\*: Refer to manual of SM-BH80, SM-BH59 (brake hose 10 m coil) for assembling / disassembling banjo unit

-: Impossible to use

		SM-BH59-J-SS	SM-BH59-JK-SS (MTB)	SM-BH59-JK-SS (ROAD)	SM-BH59-SB	SM-BH59-SB-J
Connection		Straight - Straight	Straight - Straight	Straight - Straight	Straight - Banjo	Straight - Banjo
Rigidity		Standard	Standard	Standard	Standard	Standard
ST-R9270	BR-R9270	-	-	-	-	-
ST-R9120 ST-R9170	BR-R9170	-	-	-	-	-
ST-R9180	BR-R9170	-	-	-	-	-
ST-R8170	BR-R8170	-	-	-	-	-
ST-R8020 ST-R8070	BR-R8070	-	-	-	-	-
<a href="#">ST-R7120</a>	BR-R7170	-	-	-	-	-
ST-R7170	BR-R7170	-	-	-	-	-
ST-R7020	BR-R7070	-	-	-	-	-
ST-R7025	BR-R7070	-	-	-	-	-
<a href="#">ST-R785</a>	<a href="#">BR-RS805</a>	✓	-	-	-	-
<a href="#">ST-R785</a>	BR-RS785	✓	-	-	-	-
<a href="#">ST-R785</a>	<a href="#">BR-R785</a>	-	-	-	✓	✓
ST-RS685	<a href="#">BR-RS805</a>	✓	-	✓	-	-
ST-RS685	BR-RS785	✓	-	✓	-	-
ST-RS685	<a href="#">BR-R785</a>	-	-	-	✓	✓
<a href="#">ST-RS505</a>	BR-RS785	✓	-	✓	-	-
<a href="#">ST-RS505</a>	<a href="#">BR-RS505</a>	✓	-	✓	-	-
ST-RS405	BR-RS405	-	-	✓	-	-
BL-RS600	BR-RS405	-	✓	-	-	-
<a href="#">ST-RX820</a>	<a href="#">BR-RX820</a>	-	-	-	-	-
ST-RX815	BR-RX810	-	-	-	-	-
ST-RX810-LE	BR-RX820-LE	-	-	-	-	-
BL-T8100-LE	BR-RX820-LE	-	-	-	-	-
ST-RX810	BR-RX810	-	-	-	-	-
<a href="#">BL-RX820</a>	<a href="#">BR-RX820</a>	-	-	-	-	-
BL-RX810	BR-RX810	-	-	-	-	-
<a href="#">ST-RX610</a>	BR-RX400	-	-	-	-	-
ST-RX600	BR-RX400	-	-	-	-	-
<a href="#">BL-RX610</a>	BR-RX400	-	-	-	-	-
BL-RX600	BR-RX400	-	-	-	-	-
ST-RX400	BR-RX400	-	-	-	-	-

Level of compatibility

✓: Compatible

\*: Refer to manual of SM-BH80, SM-BH59 (brake hose 10 m coil) for assembling / disassembling banjo unit



-: Impossible to use

Banjo screw	Special	Normal	Short	BR-M9120 SPEC.	BR-M8100 SPEC.
BR-M9120	-	-	-	✓	-
BR-M9000	✓	-	-	-	-
BR-M9020	✓	✓	-	-	-
BR-M820	-	-	✓	-	✓
BR-M8100	-	-	-	-	✓
BR-M8120	-	-	-	✓	-
BR-M8000	✓	✓	-	-	-
BR-M8020	-	-	✓	-	-
BR-M7100	-	-	-	-	✓
BR-M7120	-	-	-	✓	-
BR-M7000	✓	✓	-	-	-
BR-M640	-	-	✓	-	✓
BR-S700	✓	✓	-	-	-
BR-R785	✓	✓	-	-	-
BR-U8000	-	-	-	-	✓
BR-U8020	-	-	-	✓	-

**NOTE**  
See [C-188](#) for shape of banjo screws.

## Brake pad line-up

### Brake pad for hydraulic disc brake (4-piston) C-652

Pad Shape Type							
	D-type		H-type		N-type		
	Narrow type		Narrow type		Narrow type		
Type	D03S-RX	D02S-MX	H03A-RF	H03C-MF	N03A-RF	N04C-MF	
	Resin	Metal	Resin	Metal	Resin	Metal	
Characteristics	Modulation	★★★★★	★★★★☆	★★★★★	★★★★☆	★★★★★	★★★★☆
	Power	★★★★☆	★★★★★	★★★★☆	★★★★★	★★★★☆	★★★★★
	Durability	★★★★★	★★★★★	★★★★★	★★★★★	★★★★★	★★★★★
	Anti-fading	★★★☆☆	★★★★★	★★★★☆	★★★★★	★★★★☆	★★★★★
	Silence	★★★★★	★★★☆☆	★★★★★	★★★★☆	★★★★★	★★★★☆
Pad Radiator fin	-	-	✓	✓	✓	✓	
High heat insulation	-	-	-	-	-	-	
Pad Back plate	Titanium	-	-	-	-	-	
	Aluminum	-	-	✓	-	✓	
	Stainless steel/ Aluminum	-	-	-	✓	-	✓
	Stainless steel	✓	✓	-	-	-	-
BR-M9120	Hydraulic	Option	Option	-	-	Standard	Standard
BR-M8120	Hydraulic	Option	Option	-	-	Standard	Standard
BR-M7120	Hydraulic	Standard	Option	-	-	Standard	Option
BR-M6120	Hydraulic	Standard	Option	-	-	-	-
BR-MT520	Hydraulic	Standard	Standard	-	-	-	-
BR-MT420	Hydraulic	Standard	Standard	-	-	-	-
BR-M8020	Hydraulic	Option	-	Standard	Option	-	-
BR-M820	Hydraulic	-	-	Standard	Standard	-	-
BR-U8020	Hydraulic	Standard	Option	-	-	Standard	Option

# Brake pad for hydraulic disc brake (2-piston) and mechanical disc brake

C-653

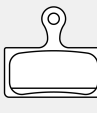
Pad Shape Type									
		B-type		G-type					
		Wide type		Narrow type					
Type		B03S-RX	B05S-RX	G03A-RX	G05A-RX	G03S-RX	G05S-RX	G04S-MX	G04Ti-MX
		Resin	Resin	Resin	Resin	Resin	Resin	Metal	Metal
Characteristics	Modulation	★★★★★	★★★★★	★★★★★	★★★★★	★★★★★	★★★★★	★★★★☆	★★★★☆
	Power	★★★★☆	★★★★☆	★★★★☆	★★★★☆	★★★★☆	★★★★☆	★★★★★	★★★★★
	Durability	★★★★★	★★★★★*1	★★★★★	★★★★★*1	★★★★★	★★★★★*1	★★★★★	★★★★★
	Anti-fading Silence	★★★☆☆	★★★☆☆	★★★☆☆	★★★☆☆	★★★☆☆	★★★☆☆	★★★★★	★★★★☆
Pad Radiator fin		-	-	-	-	-	-	-	-
High heat insulation		-	-	✓	✓	✓	✓	-	-
Pad Back plate	Titanium	-	-	-	-	-	-	-	✓
	Aluminum	-	-	✓	✓	-	-	-	-
	Stainless steel/ Aluminum	-	-	-	-	-	-	-	-
	Stainless steel	✓	✓	-	-	✓	✓	✓	-
BR-M9100	Hydraulic	-	-	-	-	-	-	-	-
BR-M9110	Hydraulic	-	-	-	-	-	-	-	-
BR-M8100	Hydraulic	-	-	Standard	Standard	-	-	Standard	-
BR-M8110	Hydraulic	-	-	-	-	-	-	-	-
BR-M7100	Hydraulic	-	-	-	-	Standard	Standard	Standard	-
BR-M7110	Hydraulic	-	-	-	-	-	-	-	-
BR-M8000	Hydraulic	-	-	Standard	Standard	-	-	Option	-
BR-M6100	Hydraulic	-	-	-	-	Standard	Standard	Option	-
BR-M6000	Hydraulic	-	-	Standard	Standard	-	-	Option	-
BR-MT500	Hydraulic	Standard	Standard	-	-	-	-	-	-
BR-MT400	Hydraulic	Standard	Standard	-	-	-	-	-	-
BR-MT410	Hydraulic	Standard	Standard	-	-	-	-	-	-
BR-MT200	Hydraulic	Standard	Standard	-	-	-	-	-	-
BR-M375	Mechanical	Standard	Standard	-	-	-	-	-	-
BR-TX805	Mechanical	Standard	Standard	-	-	-	-	-	-
BR-R9270	Hydraulic	-	-	-	-	-	-	-	-
BR-R9170	Hydraulic	-	-	-	-	-	-	-	-
BR-R8170	Hydraulic	-	-	-	-	-	-	-	-
BR-R8070	Hydraulic	-	-	-	-	-	-	-	-
BR-R7170	Hydraulic	-	-	-	-	-	-	-	-
BR-R7070	Hydraulic	-	-	-	-	-	-	-	-
BR-4770	Hydraulic	-	-	-	-	-	-	-	-
BR-R5785	Hydraulic	-	-	Option	Option	-	-	-	-
BR-R5405	Hydraulic	-	-	-	-	-	-	-	-
<a href="#">BR-RX820</a>	Hydraulic	-	-	-	-	-	-	-	-
BR-RX820-LE	Hydraulic	-	-	-	-	-	-	-	-
BR-RX810	Hydraulic	-	-	-	-	-	-	-	-
BR-RX400	Hydraulic	-	-	-	-	-	-	-	-
BR-UR300	Hydraulic	Standard	Standard	-	-	-	-	-	-
BR-S7000	Hydraulic	-	-	-	-	Standard	-	-	-
BR-R5305	Mechanical	-	-	-	-	-	-	-	-
BR-R317	Mechanical	-	-	Standard	Standard	-	-	-	-
<a href="#">BR-U8000</a>	Hydraulic	-	-	Standard	Standard	-	-	Option	-

\*1 "05" pad is more durable than "03" pad in the same type by 40%

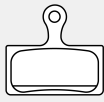
Pad Shape Type							
		K-type					
		Narrow type					
Type		K03S-RX	K05S-RX	K03Ti-RX	K05Ti-RX	K04S-MX	K04Ti-MX
		Resin	Resin	Resin	Resin	Metal	Metal
Characteristics	Modulation	★★★★★	★★★★★	★★★★★	★★★★★	★★★★☆	★★★★☆
	Power	★★★★☆	★★★★☆	★★★★☆	★★★★☆	★★★★★	★★★★★
	Durability	★★★★★	★★★★★*1	★★★★★	★★★★★*1	★★★★★	★★★★★
	Anti-fading	★★★☆☆	★★★☆☆	★★★☆☆	★★★☆☆	★★★★★	★★★★★
	Silence	★★★★★	★★★★★	★★★★★	★★★★★	★★★☆☆	★★★☆☆
Pad Radiator fin		-	-	-	-	-	-
High heat insulation		✓	✓	✓	✓	-	-
Pad Back plate	Titanium	-	-	✓	✓	-	✓
	Aluminum	-	-	-	-	-	-
	Stainless steel/ Aluminum	-	-	-	-	-	-
	Stainless steel	✓	✓	-	-	✓	-
BR-M9100	Hydraulic	-	-	Standard	Standard	-	Standard
BR-M9110	Hydraulic	-	-	Standard	Standard	-	Standard
BR-M8100	Hydraulic	-	-	-	-	-	-
BR-M8110	Hydraulic	Standard	Standard	-	-	Standard	-
BR-M7100	Hydraulic	-	-	-	-	-	-
BR-M7110	Hydraulic	Standard	Standard	-	-	Standard	-
BR-M8000	Hydraulic	-	-	-	-	-	-
BR-M6100	Hydraulic	-	-	-	-	-	-
BR-M6000	Hydraulic	-	-	-	-	-	-
BR-MT500	Hydraulic	-	-	-	-	-	-
BR-MT400	Hydraulic	-	-	-	-	-	-
BR-MT410	Hydraulic	-	-	-	-	-	-
BR-MT200	Hydraulic	-	-	-	-	-	-
BR-M375	Mechanical	-	-	-	-	-	-
BR-TX805	Mechanical	-	-	-	-	-	-
BR-R9270	Hydraulic	-	-	Standard	Standard	-	Option
BR-R9170	Hydraulic	-	-	Standard	Standard	-	Option
BR-R8170	Hydraulic	Standard	Standard	-	-	-	-
BR-R8070	Hydraulic	Standard	Standard	-	-	Option	-
BR-R7170	Hydraulic	Standard	Standard	-	-	-	-
BR-R7070	Hydraulic	Standard	Standard	-	-	Option	-
BR-4770	Hydraulic	Standard	Standard	-	-	Standard	-
BR-R5785	Hydraulic	-	-	-	-	-	-
BR-R5405	Hydraulic	Standard	Standard	-	-	-	-
<a href="#">BR-RX820</a>	Hydraulic	Standard	Standard	-	-	-	-
BR-RX820-LE	Hydraulic	Standard	Standard	-	-	-	-
BR-RX810	Hydraulic	Standard	Standard	-	-	Option	-
BR-RX400	Hydraulic	Standard	Standard	-	-	Option	-
BR-UR300	Hydraulic	-	-	-	-	-	-
BR-S7000	Hydraulic	-	-	-	-	-	-
BR-RS305	Mechanical	Standard	Standard	-	-	-	-
BR-R317	Mechanical	-	-	-	-	-	-
<a href="#">BR-U8000</a>	Hydraulic	-	-	-	-	-	-

\*1 "05" pad is more durable than "03" pad in the same type by 40%

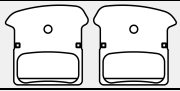
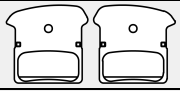

Pad Shape Type							
		J-type			L-type		
Type		Narrow type			Narrow type		
		J03A-RF	J05A-RF	J04C-MF	L03A-RF	L05A-RF	L04C-MF
		Resin	Resin	Metal	Resin	Resin	Metal
Characteristics	Modulation	★★★★★	★★★★★	★★★★☆	★★★★★	★★★★★	★★★★☆
	Power	★★★★☆	★★★★☆	★★★★★	★★★★☆	★★★★☆	★★★★★
	Durability	★★★★★	★★★★★*1	★★★★★	★★★★★	★★★★★*1	★★★★★
	Anti-fading	★★★★☆	★★★★☆	★★★★★	★★★★☆	★★★★☆	★★★★★
	Silence	★★★★★	★★★★★	★★★★☆	★★★★★	★★★★★	★★★★☆
Pad Radiator fin		✓	✓	✓	✓	✓	✓
High heat insulation		✓	✓	-	✓	✓	-
Pad Back plate	Titanium	-	-	-	-	-	-
	Aluminum	✓	✓	-	✓	✓	-
	Stainless steel/ Aluminum	-	-	✓	-	-	✓
	Stainless steel	-	-	-	-	-	-
BR-M9100	Hydraulic	-	-	-	-	-	-
BR-M9110	Hydraulic	-	-	-	-	-	-
BR-M8100	Hydraulic	Option	Option	Option	-	-	-
BR-M8110	Hydraulic	-	-	-	Option	Option	Option
BR-M7100	Hydraulic	Option	Option	Option	-	-	-
BR-M7110	Hydraulic	-	-	-	Option	Option	Option
BR-M8000	Hydraulic	Standard	Standard	Option	-	-	-
BR-M6100	Hydraulic	Standard	Standard	-	-	-	-
BR-M6000	Hydraulic	Standard	Standard	-	-	-	-
BR-MT500	Hydraulic	-	-	-	-	-	-
BR-MT400	Hydraulic	-	-	-	-	-	-
BR-MT410	Hydraulic	-	-	-	-	-	-
BR-MT200	Hydraulic	-	-	-	-	-	-
BR-M375	Mechanical	-	-	-	-	-	-
BR-TX805	Mechanical	-	-	-	-	-	-
BR-R9270	Hydraulic	-	-	-	Standard	Standard	Option
BR-R9170	Hydraulic	-	-	-	Standard	Standard	Option
BR-R8170	Hydraulic	-	-	-	Standard	Standard	Option
BR-R8070	Hydraulic	-	-	-	Standard	Standard	Option
BR-R7170	Hydraulic	-	-	-	Standard	Standard	Option
BR-R7070	Hydraulic	-	-	-	Standard	Standard	Option
BR-4770	Hydraulic	-	-	-	Option	Option	-
BR-RS785	Hydraulic	Standard	Standard	Standard	-	-	-
BR-RS405	Hydraulic	-	-	-	Option	Option	-
<a href="#">BR-RX820</a>	Hydraulic	-	-	-	Standard	Standard	Option
BR-RX820-LE	Hydraulic	-	-	-	Standard	Standard	Option
BR-RX810	Hydraulic	-	-	-	Standard	Standard	Option
BR-RX400	Hydraulic	-	-	-	Standard	Standard	Option
BR-UR300	Hydraulic	-	-	-	-	-	-
BR-S7000	Hydraulic	-	-	-	-	-	-
BR-RS305	Mechanical	-	-	-	Option	Option	-
BR-R317	Mechanical	-	-	-	-	-	-
<a href="#">BR-J8000</a>	Hydraulic	Option	Option	-	-	-	-

\*1 "05" pad is more durable than "03" pad in the same type by 40%

## How to read Model No. C-194

(1) (2) (3) (4) (5) (6)  
**SM-MA-F203S/P**

(1)	Small parts
(2)	Mount adapter
(3)	F = Front and Rear * R = Rear
(4)	Disc brake rotor size **
(5)	Caliper mount type S = International A-standard P = Post D = Flat mount
(6)	Suspension / Frame type S = International A-standard P = Post D = Flat mount

### NOTE

\* This part may be used in the rear.

In this case, the disc brake rotor size description is also different. Refer to the table below.

\*\* The disc brake rotor size description is 160 mm. Direct post mount/International A-standard forks and frames are supported. Refer to the table below for other mount types.

ARCHIVE

# Application table for adapter C-195

## For post mount brake caliper

Fork and frame mount type			Disc brake rotor size				
			140 mm (SS)	160 mm (S)	180 mm (M)	203 mm (L)	220 mm (LL)
Post mount	Front	140 mm direct	Direct mount	SM-MA90-F180P/P SM-MA-F180P/P2 (for R785)	-	-	-
		160 mm direct	-	Direct mount	SM-MA90-F180P/P SM-MA-F180P/P2	SM-MA-F203P/P	-
		180 mm direct	-	-	Direct mount	SM-MA90-F203P/PM SM-MA-F203P/PM	SM-MA-F220P/PM
		200 mm direct	-	-	-	SM-MA-F203P/PL2	SM-MA-F220P/PL2
		203 mm direct	-	-	-	Direct mount	SM-MA-F220P/PL
	Rear	140 mm direct	Direct mount	SM-MA90-F180P/P SM-MA-F180P/P2	-	-	-
		160 mm direct	-	Direct mount	SM-MA90-F180P/P SM-MA-F180P/P2	SM-MA-F203P/P	-
		180 mm direct	-	-	Direct mount	SM-MA90-F203P/PM SM-MA-F203P/PM	SM-MA-F220P/PM
		200 mm direct	-	-	-	SM-MA-F203P/PL2	SM-MA-F220P/PL2
		203 mm direct	-	-	-	Direct mount	SM-MA-F220P/PL
International A-standard	Front	-	SM-MA90-F160P/S SM-MA-F160P/S	SM-MA-F180P/S	SM-MA-F203P/S	-	
	Rear	SM-MA90-R140P/S	SM-MA90-R160P/S SM-MA-R160P/S	SM-MA90-R180P/S SM-MA-R180P/S	SM-MA-R203P/S	-	
Flat mount ø140/160	Front	SM-MA-F140P/D	SM-MA-F160P/D	-	-	-	
	Rear	SM-MA-R140P/D	SM-MA-R160P/D	-	-	-	
Flat mount ø160/180	Front	-	-	-	-	-	
	Rear	-	-	-	-	-	

## For flat mount brake caliper

Fork and frame mount type			Disc brake rotor size		
			140 mm (SS)	160 mm (S)	180 mm (M)
Flat mount	ø140/160	Front	With Y8N230000* on product	With Y8N230000* on product	-
		Rear	Direct mount	SM-MA-R160D/D	-
	ø160/180	Front	-	With Y8N230000* on product	With Y8N230000* on product
		Rear	-	Direct mount	SM-MA-R160D/D
Flat mount BR-UR300	ø140/160	Front	-	Direct mount	-
		Rear	-	Direct mount	-
	ø160/180	Front	-	-	Direct mount
		Rear	-	-	Direct mount

\* SHIMANO easy flip-flop bracket system which allow 1 bracket to be compatible with 2 rotor size.

## Polymer-coated brake cable (BC-9000 / BC-R680) compatible chart

Series	Brake with polymer-coated brake cable	
DURA-ACE	BR-R9200	✓
	BR-R9210	
	BR-R9100	
	BR-R9110	
ULTEGRA	BR-R8100	✓
	BR-R8110	
	BR-RS811-R	
	BR-R8000	
SHIMANO 105	BR-R8010	✓
	BR-R7000	
	BR-R7010	
	BR-5810	
	BR-5700	-
TIAGRA	BR-4700	✓
SORA	BR-R3000	✓
CLARIS	BR-R2000	✓
	Others	-

C-306





ARCHIVE

## Compatibility between brake systems

C-466

Depending on the brake and brake lever combination to be used, the relationship between the input at the brake lever and the actual braking force output at the wheels is very easily affected.

Be very careful when combining a brake and brake lever. Incorrect combinations can cause accidents or insufficient braking forces due to improper cable strokes. Be sure to carefully consult the chart below and select the brake and the matching brake lever.

		V-BRAKE		Roller Brake
		BR-T780 BR-MX70 BR-R573 BR-R463 BR-R353 BR-T670 BR-T610 BR-T4010 BR-T4000	With POWER MODULATOR* model BR-T780 with SM-PM70 BR-T670 with SM-PM70 BR-T610 with SM-PM70 BR-T4010 with SM-PM40 BR-T4000 with SM-PM40 BR-R573 with SM-PM70 BR-R463 with SM-PM40 BR-R353 with SM-PM70	BR-C6060-F BR-C6050-F BR-C6000 BR-C3010 BR-C3000
V-BRAKE Levers (2-finger)				
ST-M4000 ST-EF41 ST-TX800 ST-M370 ST-M310 ST-EF510 ST-EF500 ST-EF65 ST-EF51	BL-T610 BL-M571 BL-T4000 BL-MX70	✓	✓	
V-BRAKE Levers (3-finger)				
ST-T4000 ST-T3000	BL-T780 BL-T611 BL-T670 BL-T780-B BL-T4010 BL-T670-B		✓	
Brake Levers with switch				
ST-R240	BL-4600 BL-R780 BL-4700 BL-R3000 BL-R2000 BL-2400	✓	✓	NOTE
V-BRAKE lever with switch				
ST-M310 (4-finger) ST-EF65 (4-finger) ST-EF510 (4-finger) ST-EF500 (4-finger) BL-C6000			✓	NOTE
	BL-C6010 SB-C6000-8 SB-C3000-7			✓

\* POWER MODULATOR must be used for front brake

 The "NO!" symbols indicate combinations that should not be used under any circumstances.

**NOTE**  
This combination will not provide the sufficient amount of braking force.

# Brake lever with switch compatibility

Four finger brake levers such as brake levers are equipped with a switch to change between the V-BRAKE with modulator mode (for example with SM-PM40) and the caliper brake or roller brake mode.

## For V-BRAKE (with POWER MODULATOR) mode C-468

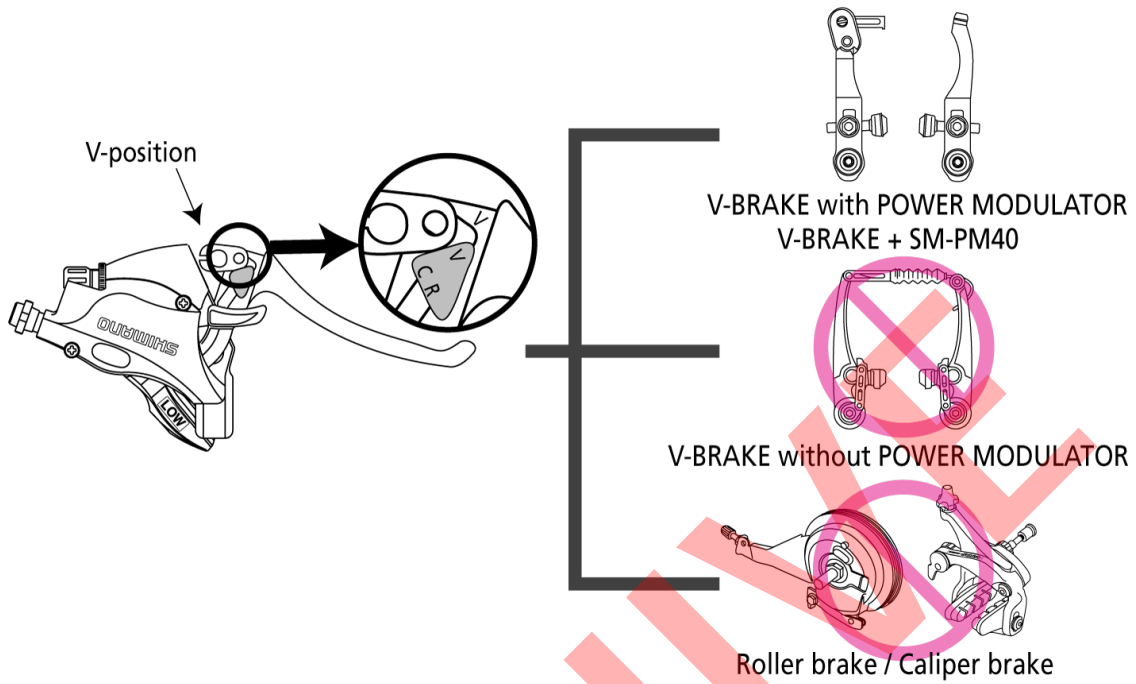

## For Caliper brake / Roller brake C-469

BL-C6010

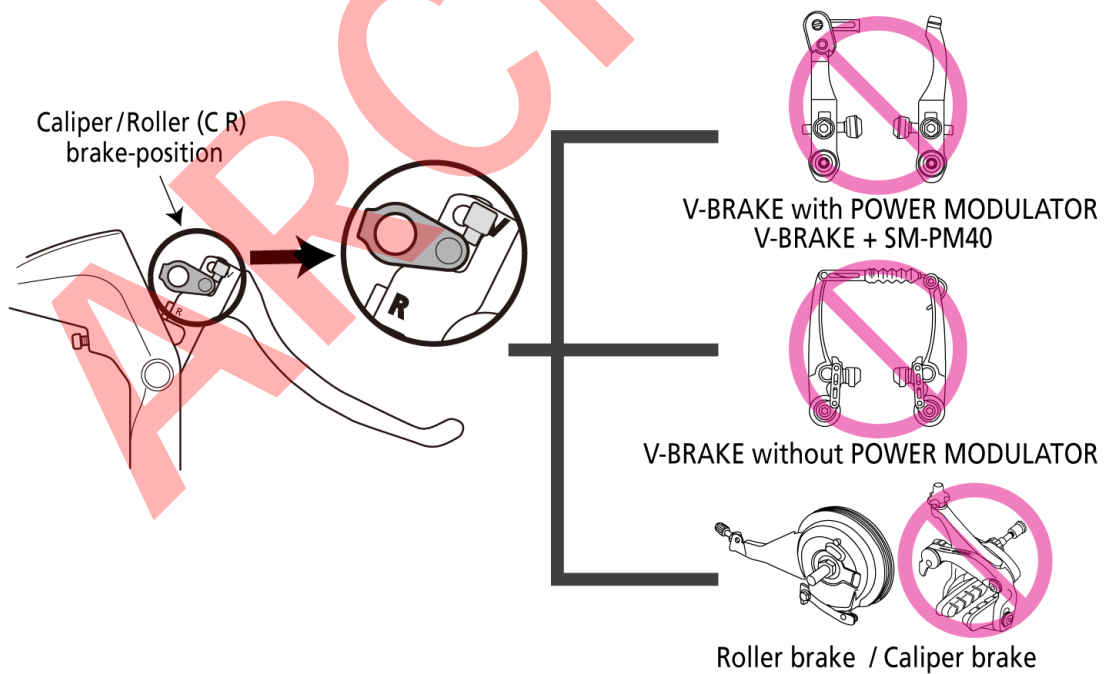

## Other models

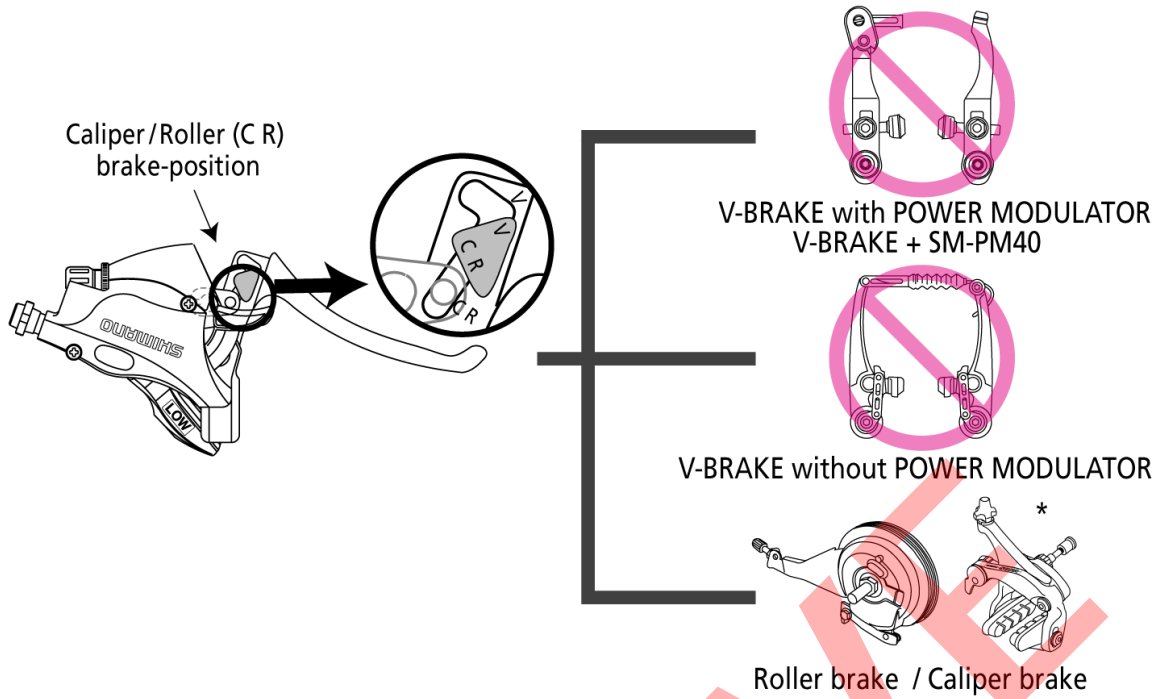

\* 3 types of caliper brake is available (SLR-EV / NEW SUPER SLR / SUPER SLR)  
Please refer Spec Hand Book for caliper brake compatibility.  
Some models can't be used with roller brake, please refer to [C-466](#) for more information.

### WARNING

If the mode is not matched to the type of brake being used, this could result in inadequate or excessive braking power. Please proceed with caution when selecting the correct mode for the corresponding brake.

## FREEHUB and cassette sprocket spline compatibility

C-731

The table below does not include LINKGLIDE cassette sprockets. See [C-649](#) for LINKGLIDE cassette sprockets.

FREEHUB			Compatible cassette sprocket type					
Free unit type	Number of effective spline teeth	Outer body length (mm)	MTB		ROAD		All	
			12-speed	11-speed	12-speed	11-speed	10/9/8-speed	7-speed
MICRO SPLINE	23	26	✓	-	-	-	-	-
HG spline L2 (ROAD 12-speed dedicated)	18	37.65	-	-	✓	-	-	-
HG spline L (ROAD 12/11-speed)	9	36.75	-	✓ *1	✓	✓ *3	✓ *2	-
HG spline M (10/9/8-speed, MTB 11-speed)	9	34.9	-	✓	-	- *4	✓ *5	-
HG spline S (7-speed)	9	31	-	-	-	-	-	✓

\*1 Need 1.85 mm low spacer.

\*2 Need 1.85 mm low spacer and 1.0 mm spacer for the cassette sprockets below.

CS-7900 / CS-7800 / CS-6700 / CS-6600 / CS-5700 / CS-5600 (1.0 mm spacer is included)

\*3 CS-HG800 / CS-HG700 of ROAD 11-speed are compatible with HG spline L by installing 1.85 mm spacer.

\*4 CS-HG800 / CS-HG700 of ROAD 11-speed are compatible with HG spline M.

\*5 Need 1.0 mm spacer for the 10-speed road cassette sprockets below.

CS-7900 / CS-7800 / CS-6700 / CS-6600 / CS-5700 / CS-5600

### Outer body length

Outer body length is length from the contact surface of the cassette sprocket of the free unit to the tip of the free unit.

#### MICRO SPLINE

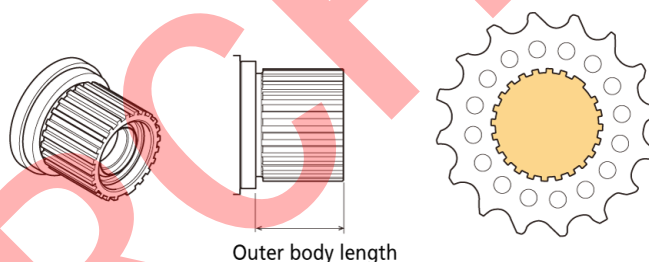

#### HG spline L2

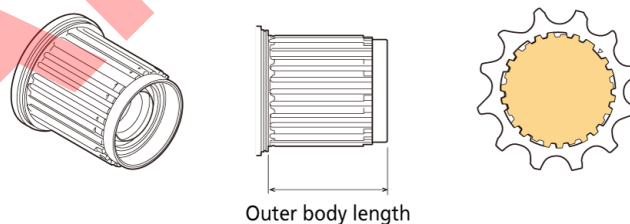

#### HG spline L/M/S

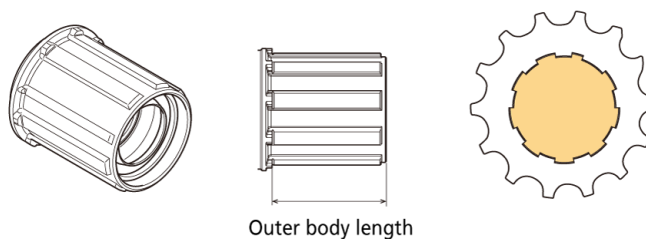



## ROAD 12/11-speed FREEHUB compatibility

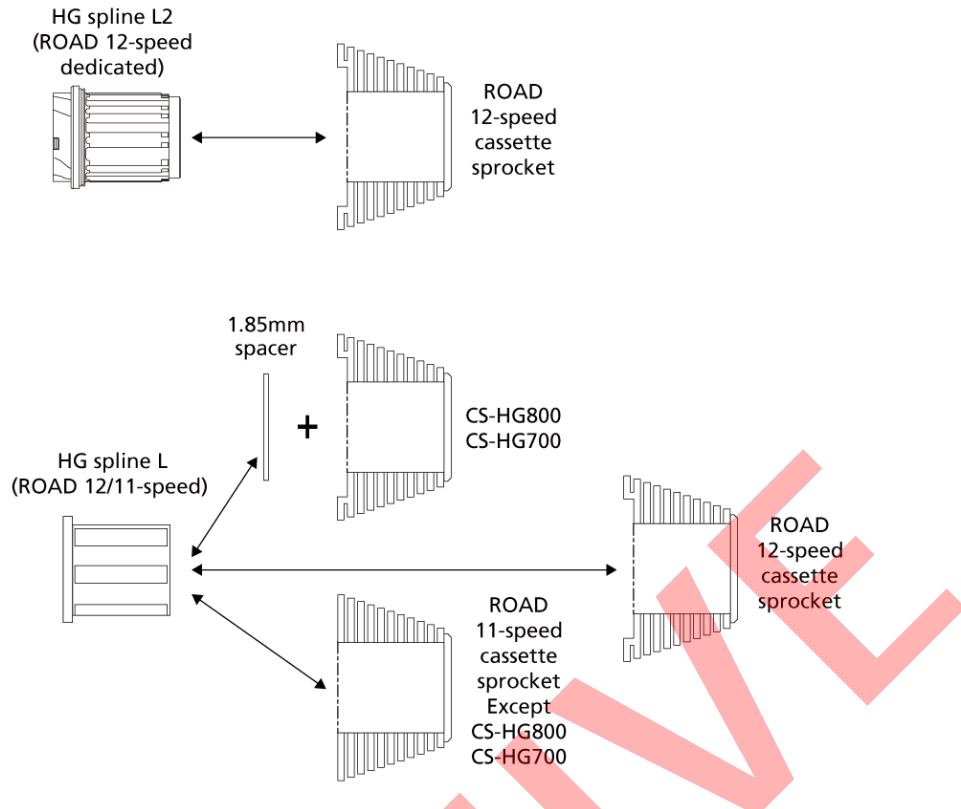

## MTB 11-speed FREEHUB compatibility

MTB 11-speed wheel and FREEHUB have same spline shape with 10, 9, 8-speed FREEHUB.

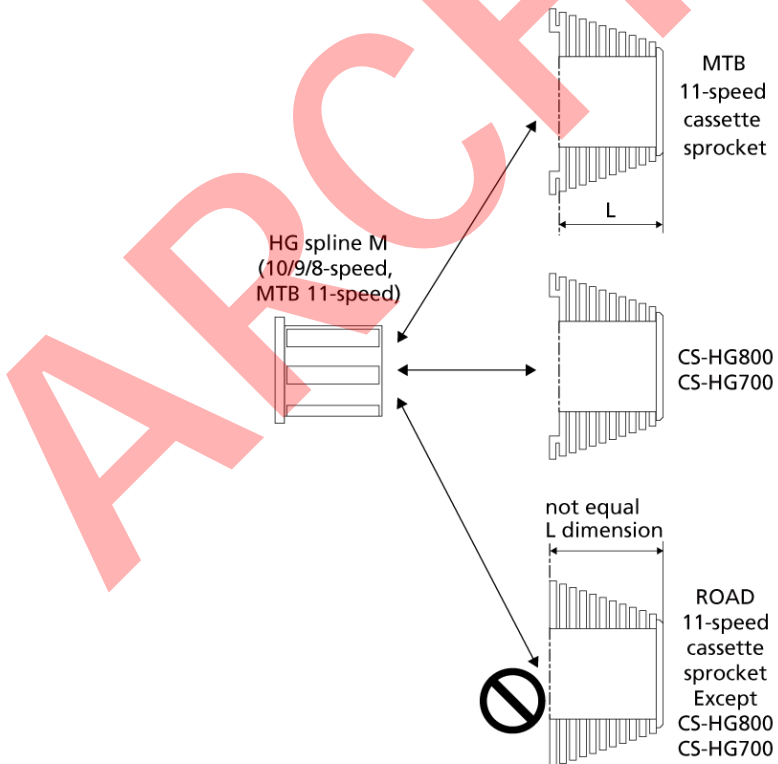

# Compatibility between rear derailleur and cassette sprocket gear teeth [ROAD, Gravel, URBAN (METREA) ]

C-254

## 12-speed C-648

Gear	RD-R9250	RD-R8150	RD-R7100	RD-R7150
11-30T	✓	✓	-	-
11-34T	✓	✓	✓	✓
11-36T	-	-	✓	✓

Gear	RD-RX820	RD-RX822	RD-RX822
	Front double	GS Front single	SGS Front single
11-34T	✓	-	-
11-36T	✓	-	-
10-45T	-	✓	-
10-51T	-	-	✓

## 11-speed C-255

Gear	RD-R9100 RD-R9150	RD-R8000 RD-R8050		RD-R7000		RD-9000	RD-6800 RD-6870 RD-5800	
	-	SS	GS Front double	SS	GS Front double	SS	SS	GS Front double
11-23T	-	-	-	-	-	✓	✓	-
11-25T	✓	✓	-	-	-	✓	✓	-
11-28T	✓	✓	✓	✓	✓	✓	✓	✓
11-30T	✓	✓	✓	✓	✓	-	-	✓
11-32T	-	-	✓	-	✓	-	-	✓
11-34T	-	-	✓	-	✓	-	-	-
11-40T	-	-	-	-	-	-	-	-
11-42T	-	-	-	-	-	-	-	-
12-25T	✓	✓	-	✓	-	✓	✓	-
12-28T	✓	✓	✓	-	✓	✓	✓	✓
14-28T	✓	✓	-	✓	-	✓	✓	-

Gear	RD-RX800 RD-RX805	RD-RX810 RD-RX815	RD-RX812 RD-RX817	RD-U5000-SS
	GS Front double	Closer Front double	Wider Front single	SS
11-23T	-	-	-	-
11-25T	-	-	-	-
11-28T	✓	-	-	✓
11-30T	✓	✓	-	✓
11-32T	✓	✓	-	✓
11-34T	✓	✓	-	-
11-40T	-	-	✓	-
11-42T	-	-	✓	-
12-25T	-	-	-	-
12-28T	-	-	-	-
14-28T	-	-	-	-

## 10-speed C-256

Gear	RD-4700			RD-4601			RD-RX400
	SS	GS Front double	GS Front triple	SS	GS Front double	GS Front triple	Closer Front double
11-25T	✓	-	✓	✓	-	✓	-
11-27T	✓	-	✓	✓	✓	✓	-
11-28T	-	✓	✓	✓	✓	✓	-
11-32T	-	✓	✓	-	✓	-	✓
11-34T	-	✓	-	-	-	-	✓
11-36T	-	-	-	-	-	-	✓
12-25T	✓	-	✓	✓	-	✓	-
12-27T	✓	-	✓	✓	✓	✓	-
12-28T	✓	✓	✓	✓	✓	✓	-
12-30T	-	✓	✓	✓	✓	✓	-
13-25T	✓	-	-	✓	-	✓	-
14-25T	✓	-	-	✓	-	✓	-

## 9-speed C-257

Gear	RD-R3000		
	SS	GS Front double	GS Front triple
11-25T	✓	-	-
11-28T	✓	✓	✓
11-30T	✓	✓	✓
11-32T	✓	✓	✓
11-34T	-	✓	-
12-25T	✓	-	-
12-27T	✓	-	-
13-25T	✓	-	-
14-25T	✓	-	-

## 8-speed C-258

Gear	RD-R2000		
	SS	GS Front double	GS Front triple
11-28T	✓	✓	✓
11-30T	✓	✓	✓
11-32T	✓	✓	✓
11-34T	-	✓	-
12-25T	✓	-	✓
13-26T	✓	-	-

## 7-speed C-259

Gear	RD-A070
	SMART CAGE
11-28T	✓
12-28T	✓
13-28T	✓
14-28T	✓

# LINKGLIDE cassette sprocket and FREEHUB compatibility

C-649

LINKGLIDE cassette sprockets are not compatible with MICRO SPLINE FREEHUB.





Freewheel body type	FREEHUB spec.	Model No.	CS-LG700-11 CS-LG600-11 CS-LG400-11	CS-LG600-10 CS-LG400-10 CS-LG300-10	CS-LG400-9 CS-LG300-9
HG spline M (10/9/8-speed, MTB 11-speed)	O.L.D. 148 mm, E-THRU type	FH-M8010-B	✓	✓	✓
		FH-M6010-B			
		FH-TC600-HM-B			
		FH-TC500-HM-B			
	O.L.D. 141 mm, Quick release type	FH-MT400-B	✓	✓	✓
		FH-MT200-B			
	O.L.D. 150 mm, E-THRU type	FH-M825	✓	✓	✓
		O.L.D. 135 mm, E-THRU type	FH-M820	- *2	✓
	O.L.D. 142 mm, E-THRU type	FH-M8010	- *2	✓	✓
		FH-M6010			
		FH-MT400			
		FH-TC500-HM	✓	✓	✓
	O.L.D. 135 mm, Quick release type	FH-M9000	- *2	✓	✓
		FH-M8000			
		FH-M6000			
		FH-M4050			
		FH-M3050			
		FH-RM35			
		FH-TX505-8			
		FH-M756-A			
FH-M525					
FH-M475					
FH-TX506					
FH-T610					
FH-T3000					
FH-TX500-8-QR					
FH-TX500-8-NT					
FH-QC400-HM	✓	✓	✓		
FH-QC300-HM	✓	✓	✓		
O.L.D. 130 mm, Quick release type	FH-RS300	- *2	✓	✓	
HG spline L (ROAD 12/11-speed)	O.L.D. 142 mm, E-THRU type	FH-R7070	✓ *1	✓ *1	✓ *1
		FH-R5770			
		FH-R5470			
	O.L.D. 135 mm, Quick release type	FH-UR600	✓ *1	✓ *1	✓ *1
		O.L.D. 130 mm, Quick release type	FH-R7000	- *2	✓ *1
	FH-RS400				

\*1 Need low spacer (1.85 mm.)

\*2 Interference may occur with the rear derailleur and spokes.

## Available combinations of the dropout, cassette sprocket/single gear and crankset for designing the frame

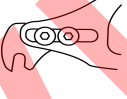
C-471

Dropout design	A	Reversed (BMX) type, without derailleur hanger	
	B	Standard type, without derailleur hanger	
	C	Adjustable disc brake mount / Eccentric bottom bracket	
	D	Vertical type, with derailleur hanger	
Compatibility	NR: Not recommend		-
Crankset	E	FC-C6000	-
	F	FC-S501: Double guard spec	-
	G	FC-S501: Single guard spec	-
	K	SM-CRE61 / SM-CRE50	-
CN	H	CN-NX10 (1/2 x 1/8 inch) or HG 85 (1/2 x 3/32 inch)	-
	I	Super Narrow HG 95	-
	J	HG 85 (1/2 x 3/32 inch)	-

Series	Speed	Brake type	Dropout design	Compatibility	CT use *5	CS / SM-GEAR	FC	CN	additional condition
ALFINE	11S / 8S	Disc brake	A	NR	-	-	-	-	*1
			B	NR	-	-	-	-	
			C	OK	-	SM-GEAR	G	J	-
			D	OK	CT-S500	CS-S500	F	I	-
		OK		CT-S510	SM-GEAR	G	J	-	
		V-BRAKE	A	OK	-	SM-GEAR	G	J	-
			B	OK	-	SM-GEAR	G	J	-
			C	OK	-	SM-GEAR	G	J	-
D	OK		CT-S500	CS-S500	F	I	-		
	OK	CT-S510	SM-GEAR	G	J	-			
NEXUS	8S / 7S	Disc brake	A	NR	-	-	-	-	*1
			B	NR	-	-	-	-	
			C	OK	-	SM-GEAR	G	J	-
			D	OK	CT-S500	CS-S500	F	I	-
	OK	CT-S510		SM-GEAR	G	J	-		
	8S / 7S / 3S (except 3D)	Hub roller brake V-BRAKE	A	OK	-	SM-GEAR	E	H	-
			B	OK	-	SM-GEAR	G	J	-
				OK	-	SM-GEAR	E	H	-
			C	OK	-	SM-GEAR	G	J	-
		NR		CT-S500 (except 3s)	CS-S500	F	I	*2	
		D	OK	CT-S510 (except 3s)	SM-GEAR	G	J	-	
			Coaster brake	A	OK	-	SM-GEAR	E	H
		B		OK	-	SM-GEAR	G	J	-
				OK	-	SM-GEAR	E	H	-
		C		OK	-	SM-GEAR	G	J	-
			D	NR	-	-	-	-	*3
		NR		-	-	-	-	-	*4
	3D	Disc brake	A	NR	-	-	-	-	*1
			B	NR	-	-	-	-	
			C	OK	-	SM-GEAR	G	J	-
			D	OK	-	CS-S500	F	I	-
		OK		-	SM-GEAR	G	J	-	
		V-BRAKE	A	OK	-	SM-GEAR	G	J	-
			B	OK	-	SM-GEAR	G	J	-
			C	OK	-	SM-GEAR	G	J	-
			D	OK	-	CS-S500	F	I	-
		OK		-	SM-GEAR	G	J	-	
		5S for E-BIKE	Disc brake	A	NR	-	-	-	-
B				NR	-	-	-	-	
C	OK			-	CS-C7000	K	J	-	
D	NR			-	-	-	-	-	
Hub roller brake V-BRAKE	A		OK	-	CS-C7000	K	J	-	
	B		OK	-	CS-C7000	K	J	-	
	C		OK	-	CS-C7000	K	J	-	
	D		NR	-	-	-	-	-	
Coaster brake	A		OK	-	CS-C7000	K	J	-	
	B		OK	-	CS-C7000	K	J	-	
	C		OK	-	CS-C7000	K	J	-	
	D		NR	-	-	-	-	-	

\*1 Special disc brake mount design is needed.

\*2 without chain guard for hub gear side.

\*3 Structure of CT-S500 can't transfer chain tension by back pedaling.

\*4 Not enough force of fixation against back pedaling power.

\*5 Chain tensioners are not compatible with MU-UR510.

# Mechanical internal geared hub / SM (CJ) COMPATIBILITY CHART

C-647

Internal Geared Hub (SG)		Spec.	Small Parts Set (SM)	Cassette Joint (CJ) * CJ is included in SM parts set
ALFINE-11	SG-S7001-11	11s, Disc brake, Premium	SM-S700 SM-S700-BD *1	CJ-S700 CJ-S700-BD *1
ALFINE-8	SG-S7001-8	8s, Disc brake, Premium	SM-S7000-8 SM-S7000-8BD *1	CJ-S7000-8 CJ-S7000-8BD *1
INTER-8	SG-C6011-8R	8s, Roller brake, Premium	SM-8S31 SM-8S31BD *1	CJ-8S20 / CJ-8S40 CJ-8S20BD *1
	SG-C6011-8V	8s, V-BRAKE, Premium		
	SG-C6001-8R	8s, Roller brake		
	SG-C6001-8V	8s, V-BRAKE		
	SG-C6001-8C	8s, Coaster brake		
	SG-C6001-8D	8s, Disc brake		
INTER-7	SG-C3001-7R	7s, Roller brake	SM-7R45 SM-7C25 *1	CJ-NX10 / CJ-NX40
	SG-C3001-7V	7s, V-BRAKE	SM-7C25	CJ-NX10 / CJ-NX40
	SG-C3001-7C	7s, Coaster brake	SM-7R45 SM-7C25 *1	CJ-NX10 / CJ-NX40
	SG-C3001-7D	7s, Disc brake		
INTER-5E	SG-C7000-5R	5s, Roller brake, Premium	SM-C7000-5 SM-C7000-5BD *1	CJ-C7000-5 CJ-C7000-5BD *1
	SG-C7000-5V	5s, V-BRAKE, Premium		
	SG-C7000-5C	5s, Coaster brake, Premium		
	SG-C7000-5D	5s, Disc brake, Premium		
	SG-C7002-5CD	5s, Coaster brake & Disc brake		
INTER-5	SG-5R30 (Japan Only)	5s, Roller brake, Japan only	SM-5S30	CJ-8S20 / CJ-8S40
	SG-5R30-VS (Japan Only)	5s, V-BRAKE, Japan only		
	SG-5R35 (Japan Only)	5s, Roller brake, Alloy body, Japan only		
	SG-5R35-VS (Japan Only)	5s, V-BRAKE, Alloy body, Japan only		
INTER-3	SG-3R42 (Japan Only)	3s, Roller brake, Japan only	SM-3R40	-
	SG-3R40 (Japan Only)	-		
	SG-3R40	3s, Roller brake	SM-3R40	SM-BC03 SM-BC06
	SG-3C41	3s, Coaster brake	SM-3R41	-
	SG-3D55	3s, Disc brake	SM-3D55	SM-BC03 SM-BC06
	SG-3R75	3s, Roller brake, Premium	SM-3S70	CJ-NX10 / CJ-NX40

\*1 : Dedicated specs for belt drive system

## Single gear and chain combination

C-608

Series	Single gear		Chain
	Model No.	Gear thickness (mm)	Model No.
ALFINE	CS-5500	2.0	CN-E6070 CN-HG93 CN-HG53
NEXUS	SM-GEAR (2.3 mm) CS-C7000	2.3	CN-HG71 CN-HG40
	SM-GEAR (3.0 mm)	3.0	CN-NX10

## Compatibility for DIN 79010:2020-02

C-672

### DIN 79010:2020-02

Fahrräder - Transport- und Lastenfahrrad - Anforderungen und Prüfverfahren für ein- und mehrspurige Fahrräder

(Cycles - Transportation bikes and cargo bikes - Requirements and test methods for single- and multi-track cycles)

Products		Model No.	DIN 79010:2020-02 (Type 1: Single Track) conformance
BRAKE (BR, RT)	Group #1	BR-M9120 / BR-M8120 / BR-M7120 + RT-MT900 / RT-EM910	YES with conditions (*1)
	Group #2	BR-M9120 / BR-M8120 / BR-M7120 + RT-MT800 / RT-EM810	
	Group #3	BR-M9120 / BR-M8120 / BR-M7120 + SM-RT86	
	Group #4	BR-M6120 + SM-RT30 / RT-EM300 / SM-RT66	
	Group #5	BR-MT520 / BR-MT420 + SM-RT30 / RT-EM300 / SM-RT66	
HUB (HB, FH, SG)	FH	FH-M**** / MT*** / TX*** / RS*** / UR*** series	YES (*SHIMANO can't guarantee assembled wheel performance. Please confirm wheel performance by bike manufacturer.)
	SG	SG-C7000-5D / SG-C7050-5D / SG-C6001-8D / SG-C6061-8D SG-C3001-7D	
	HB	HB-M**** / MT*** / TX*** / RS*** series	
	DH	All	
OTHERS	All not mentioned above (DU, CS, CN, RD, FC, etc.)	All	NO YES No special requirement if compare with ISO/EN4210-2 2015

### (\*1) conditions

#### Product Spec requirements

Group	Brake pad	RT size	Hose length
			(*Please consider Brake Lever reach adjustment)
Group #1,2,3	Resin pad w/ radiator fin	203 mm (L size)	2200 mm or less (Tire outer diameter = 660 mm or less) 2400 mm or less (Tire outer diameter = 559 mm or less) 2700 mm or less (Tire outer diameter = 406 mm or less)
		180 mm (M size)	1300 mm or less (Tire outer diameter = 660 mm or less) 2000 mm or less (Tire outer diameter = 559 mm or less) 2400 mm or less (Tire outer diameter = 406 mm or less)
Group #4	Resin pad w/o radiator fin	203 mm (L size)	2200 mm or less (Tire outer diameter = 660 mm or less) 2400 mm or less (Tire outer diameter = 559 mm or less) 2700 mm or less (Tire outer diameter = 406 mm or less)
		180 mm (M size)	1300 mm or less (Tire outer diameter = 660 mm or less) 2000 mm or less (Tire outer diameter = 559 mm or less) 2400 mm or less (Tire outer diameter = 406 mm or less)
Group #5	Resin pad w/o radiator fin	203 mm (L size) 180 mm (M size)	3000 mm or less (Tire outer diameter = 660 mm or less)

#### Limitation & adjustment

Group	RT size	DIN 79010:2020-02 5.5.2.2.2 Weight factor "c" (*2)	Brake lever adjustment
Group #1	203 mm (L size)	c = 1.5	Brake lever reach adjustment might be required to follow minimum braking force value of 5.5.1.3
	180 mm (M size)	c = 1.4	
Group #2	203 mm (L size)	c = 1.4	
	180 mm (M size)	c = 1.3	
Group #3	203 mm (L size)	c = 1.3	
	180 mm (M size)	c = 1.1	
Group #4,5	203 mm (L size)	c = 1.1	
	180 mm (M size)	c = 0.9	

### (\*2) Refer to DIN 79010:2020-02 5.5.2.2.2 about "c" value.

c: weight factor which is defined by bike design.  $c = (AL: \text{axle load}) / (M: 100 \text{ kgf as basic value})$ .  
For example, axle load is allowed till 150 kgf if  $c = 1.5$ .



## Spoke protector

C-491

Select the spoke protector after checking the chart below.

It is decided by hole number of hub and number of the gear teeth, other than multiple freewheel.

Cassette sprocket		Spoke protector model																		
		Flange diameter of rear hub (FH side)															53.8 mm		70.6 mm	
		Number of largest sprocket teeth											Spoke hole number				Spoke hole number			
Speed	Model No.	25T	28T	30T	32T	34T	36T	40T	42T	45T	46T	51T	28H	32H	36H	28H	32H	36H		
12-speed	CS-M9101	-	-	-	-	-	-	-	-	✓	-	✓	-	-	-	-	-	-		
	CS-M9100	-	-	-	-	-	-	-	-	✓	-	✓	-	-	-	-	-	-		
	CS-M8100	-	-	-	-	-	-	-	-	✓	-	✓	-	-	-	-	-	-		
	CS-M7100	-	-	-	-	-	-	-	-	✓	-	✓	-	-	-	-	-	-		
	CS-M6100	-	-	-	-	-	-	-	-	-	-	✓	-	-	-	-	-	-		
11-speed	CS-M9001	-	-	-	-	-	-	✓	-	-	-	-	-	-	-	-	-	-		
	CS-M8000	-	-	-	-	-	-	✓	✓	-	✓	-	-	-	-	-	-	-		
	CS-M7000	-	-	-	-	-	-	✓	✓	-	✓	-	-	-	-	-	-	-		
	CS-M5100	-	-	-	-	-	-	-	✓	-	-	✓	-	-	-	-	-	-		
10-speed	CS-M4100	-	-	-	-	-	-	-	✓	-	✓	-	-	-	-	-	-	-		
	CS-M771-10	-	-	-	✓	✓	✓	-	-	-	-	-	-	CP-FH56	CP-FH53	-	CP-FH76	CP-FH76		
	CS-HG81-10	-	-	-	-	✓	✓	-	-	-	-	-	-	CP-FH56	CP-FH53	-	CP-FH76	CP-FH76		
	CS-HG500-10	✓	✓	-	✓	✓	-	-	✓	-	-	-	-	-	-	-	-	-		
9-speed	CS-HG50-10	-	-	-	-	-	✓	-	-	-	-	-	-	CP-FH56	CP-FH53	-	-	-		
	CS-HG400-9	-	-	-	-	-	✓	-	-	-	-	-	-	CP-FH56	CP-FH53	-	CP-FH76	CP-FH76		
	CS-HG300-9	-	-	-	-	-	✓	-	-	-	-	-	-	CP-FH56	CP-FH53	-	CP-FH76	CP-FH76		
	CS-HG201-9	-	-	-	✓	✓	-	-	-	-	-	-	CP-WH12	CP-FH56	CP-FH53	-	CP-FH76	CP-FH76		
	CS-HG200-9	-	-	-	✓	✓	-	-	-	-	-	-	CP-WH12	CP-FH56	CP-FH53	-	CP-FH76	CP-FH76		
	CS-HG400-9	-	✓	-	-	-	-	-	-	-	-	-	-	CP-FH35	CP-FH50	-	CP-FH76	CP-FH76		
	CS-HG300-9	-	✓	-	-	-	-	-	-	-	-	-	-	CP-FH35	CP-FH50	-	CP-FH76	CP-FH76		
8-speed	CS-ROAD	-	✓	-	-	-	-	-	-	-	-	-	CP-FH08	CP-FH35	CP-FH31	-	-	-		
	CS-HG60-81	-	-	-	-	✓	-	-	-	-	-	-	CP-WH12	CP-FH56	CP-FH53	-	CP-FH76	CP-FH76		
	CS-HG51-8	-	✓	✓	-	-	-	-	-	-	-	-	CP-FH40	CP-FH35	CP-FH50	-	-	-		
	CS-HG51-8	-	-	-	-	✓	-	-	-	-	-	-	CP-WH12	CP-FH56	CP-FH53	-	CP-FH76	CP-FH76		
	CS-HG41-8	-	-	✓	-	-	-	-	-	-	-	-	CP-FH40	CP-FH35	CP-FH50	-	-	-		
	CS-HG31-8	-	-	✓	-	-	-	-	-	-	-	-	CP-FH40	CP-FH35	CP-FH50	-	-	-		
7-speed	CS-HG41-8	-	-	-	✓	✓	-	-	-	-	-	-	CP-WH12	CP-FH56	CP-FH53	-	CP-FH76	CP-FH76		
	CS-HG31-8	-	-	-	✓	✓	-	-	-	-	-	-	CP-WH12	CP-FH56	CP-FH53	-	CP-FH76	CP-FH76		
	CS-HG200-8	-	-	-	✓	-	-	-	-	-	-	-	CP-WH12	CP-FH56	CP-FH53	-	CP-FH76	CP-FH76		
	CS-HG41-7	-	✓	-	-	-	-	-	-	-	-	-	CP-FH40	CP-FH35	CP-FH50	-	-	-		
7-speed	CS-HG200-7	-	-	-	✓	-	-	-	-	-	-	-	-	CP-FH56	CP-FH53	-	CP-FH76	CP-FH76		
	CS-HG200-7	-	✓	-	-	-	-	-	-	-	-	-	-	CP-FH35	CP-FH50	-	-	-		

## 12-speed

Model No.	Cassette sprocket		Spoke protector model					
	Number of largest sprocket teeth		WH-M8100	WH-M8120	WH-MT620	WH-MT601	WH-MT501	WH-M9000 WH-M9020 WH-M8000 WH-M8020 WH-M8000-B WH-M8020-B
	45T	51T						
CS-M9101	✓	✓	CP-WH28	CP-WH32 (for 10-45T) CP-WH29 (for 10-51T)	CP-WH31 (for 10-45T) <a href="#">CP-WRX8B</a>	CP-WH31 (for 10-45T) <a href="#">CP-WRX8B</a>	CP-WH31 (for 10-45T) <a href="#">CP-WRX8B</a>	-
<a href="#">CS-M9100</a>	✓	✓						-
CS-M8100	✓	✓						-
CS-M7100	✓	✓						-
CS-M6100	-	✓						-

Model No.	Cassette sprocket		Spoke protector model				
	Number of largest sprocket teeth		WH-MT600	WH-MT500	WH-MT66-29	WH-MT35 WH-MT35-275 WH-MT35-29 WH-MT15-A-275 WH-MT15-A-29	<a href="#">WH-RX880</a> (MICRO SPLINE)
	45T	51T					
CS-M9101	✓	✓	-	-	-	-	<a href="#">CP-WRX8B</a>
<a href="#">CS-M9100</a>	✓	✓	-	-	-	-	
CS-M8100	✓	✓	-	-	-	-	
CS-M7100	✓	✓	-	-	-	-	
CS-M6100	-	✓	-	-	-	-	

## 11-speed

Model No.	Cassette sprocket						Spoke protector model				
	Number of largest sprocket teeth						WH-M8100	WH-M8120	WH-MT620	WH-MT601	WH-MT501
	40T	42T	45T	46T	50T	51T					
<a href="#">CS-M9001</a>	✓	-	-	-	-	-	-	-	-	-	-
CS-M8000	✓	✓	-	✓	-	-	-	-	-	-	-
<a href="#">CS-M7000</a>	✓	✓	-	✓	-	-	-	-	-	-	-
CS-M5100	-	✓	-	-	-	✓	-	-	-	-	-
CS-LG700-11	-	-	✓	-	✓	-	-	-	-	-	-
<a href="#">CS-LG600-11</a>	-	-	-	-	✓	-	-	-	-	-	-
CS-LG400-11	-	-	✓	-	✓	-	-	-	-	-	-

Model No.	Cassette sprocket						Spoke protector model				
	Number of largest sprocket teeth						WH-M9000 WH-M9020 WH-M8000 WH-M8020 WH-M8000-B WH-M8020-B	WH-MT600	WH-MT500	WH-MT66-29	WH-MT35 WH-MT35-275 WH-MT35-29 WH-MT15-A-275 WH-MT15-A-29
	40T	42T	45T	46T	50T	51T					
<a href="#">CS-M9001</a>	✓	-	-	-	-	-	CP-WH17-A	CP-WH26	-	-	-
CS-M8000	✓	✓	-	✓	-	-	CP-WH17-A	CP-WH26	-	-	-
<a href="#">CS-M7000</a>	✓	✓	-	✓	-	-	CP-WH17-A	CP-WH26	-	-	-
CS-M5100	-	✓	-	-	-	✓	CP-WH17-A (for 42T)	CP-WH26 (for 42T)	-	-	-
CS-LG700-11	-	-	✓	-	✓	-	-	-	-	-	-
<a href="#">CS-LG600-11</a>	-	-	-	-	✓	-	-	-	-	-	-
CS-LG400-11	-	-	✓	-	✓	-	-	-	-	-	-

## 10-speed

Model No.	Cassette sprocket								Spoke protector model				
	Number of largest sprocket teeth								WH-M8100	WH-M8120	WH-MT620	WH-MT601	WH-MT501
	32T	34T	36T	39T	42T	43T	46T	48T					
CS-M4100	-	-	-	-	✓	-	✓	-	-	-	-	-	-
CS-M771-10	✓	✓	✓	-	-	-	-	-	-	-	-	-	-
CS-HG81-10	-	✓	✓	-	-	-	-	-	-	-	-	-	-
CS-HG500-10	-	-	-	-	✓	-	-	-	-	-	-	-	-
CS-HG50-10	-	-	✓	-	-	-	-	-	-	-	-	-	-
CS-LG600-10	-	-	-	-	-	✓	-	-	-	-	-	-	-
CS-LG400-10	-	-	-	✓	-	✓	-	✓	-	-	-	-	-
CS-LG300-10	-	-	-	✓	-	-	-	✓	-	-	-	-	-

Model No.	Cassette sprocket								Spoke protector model				
	Number of largest sprocket teeth								WH-M9000 WH-M9020 WH-M8000 WH-M8020 WH-M8000-B WH-M8020-B	WH-MT600	WH-MT500	WH-MT66-29	WH-MT35 WH-MT35-275 WH-MT35-29 WH-MT15-A-275 WH-M815-A-29
	32T	34T	36T	39T	42T	43T	46T	48T					
CS-M4100	-	-	-	-	✓	-	✓	-	-	-	-	-	-
CS-M771-10	✓	✓	✓	-	-	-	-	-	CP-WH16	CP-WH21	CP-WH16	CP-WH12	CP-WH12
CS-HG81-10	-	✓	✓	-	-	-	-	-	CP-WH16	CP-WH21	CP-WH16	CP-WH12	CP-WH12
CS-HG500-10	-	-	-	-	✓	-	-	-	-	CP-WH21	-	CP-WH19	CP-WH19
CS-HG50-10	-	-	✓	-	-	-	-	-	CP-WH16	CP-WH21	CP-WH16	CP-WH12	CP-WH12
CS-LG600-10	-	-	-	-	-	✓	-	-	CP-WH26	CP-WH21	-	-	-
CS-LG400-10	-	-	-	✓	-	✓	-	✓	-	-	-	-	-
CS-LG300-10	-	-	-	✓	-	-	-	✓	-	-	-	-	-

## 9-speed

Model No.	Cassette sprocket						Spoke protector model				
	Number of largest sprocket teeth						WH-M8100	WH-M8120	WH-MT620	WH-MT601	WH-MT501
	28T	32T	34T	36T	41T	46T					
CS-HG400-9 CS-HG300-9 CS-HG201-9 CS-HG200-9	-	✓	✓	✓	-	-	-	-	-	-	-
CS-HG400-9 CS-HG300-9	✓	-	-	-	-	-	-	-	-	-	-
CS-LG400-9	-	-	-	✓	✓	✓	-	-	-	-	-
CS-LG300-9	-	-	-	✓	✓	✓	-	-	-	-	-

Model No.	Cassette sprocket						Spoke protector model				
	Number of largest sprocket teeth						WH-M9000 WH-M9020 WH-M8000 WH-M8020 WH-M8000-B WH-M8020-B	WH-MT600	WH-MT500	WH-MT66-29	WH-MT35 WH-MT35-275 WH-MT35-29 WH-MT15-A-275 WH-MT15-A-29
	28T	32T	34T	36T	41T	46T					
CS-HG400-9 CS-HG300-9 CS-HG201-9 CS-HG200-9	-	✓	✓	✓	-	-	-	-	CP-WH16	CP-WH12	CP-WH12
CS-HG400-9 CS-HG300-9	✓	-	-	-	-	-	-	-	CP-WH16	CP-WH08	CP-WH08
CS-LG400-9	-	-	-	✓	✓	✓	-	-	-	-	-
CS-LG300-9	-	-	-	✓	✓	✓	-	-	-	-	-

# ROAD, Gravel, URBAN (METREA)

C-300

Model No.	Speed				Number of largest sprocket teeth									
	9	10	11**	12	23T	25T	27T	28T	30T	32T*	34T	36T	40T	42T
WH-R9270-C60	-	-	-	✓	-	-	-	-	CP-WR92C			-	-	-
WH-R9270-C50 WH-R9270-C36	-	-	-	✓	-	-	-	-	CP-WR92A			-	-	-
WH-R9200-C60 WH-R9200-C50 WH-R9200-C36	-	-	-	✓	-	-	-	-	CP-W124			-	-	-
WH-R8170-C60 WH-R8170-C50 WH-R8170-C36	-	-	✓	✓	-	-	-	CP-WR81A			-	-	-	
WH-RS710-C32 WH-RS710-C46	-	-	✓	✓	-	-	-	CP-WH24			CP-WR71A	-	-	
WH-R9170-C60 WH-R9170-C40	-	✓	✓	-	-	CP-W1460			-	-	-	-	-	
WH-R9100-C60 WH-R9100-C40	-	✓	✓	-	-	CP-W124			-	-	-	-	-	
WH-R9100-C24	-	-	✓	-	CP-WH23	CP-W120			-	-	-	-	-	
	-	✓	-	-	CP-W020			-	-	-	-	-	-	
WH-RS770-C30	-	-	✓	-	-	CP-W1460			CP-W1460	-	-	-	-	
	-	✓	-	-	-	CP-W1460			-	-	-	-	-	
WH-RS700-C30	-	-	✓	-	-	CP-W124			CP-W124	-	-	-	-	
	-	✓	-	-	-	CP-W124			-	-	-	-	-	
WH-RS500 WH-RS300 WH-RS11	-	-	✓	-	CP-WH23			-	CP-W120	-	-	-	-	
WH-RS11	-	✓	-	-	CP-W020			-	-	-	-	-	-	
WH-9000-C24-TU WH-RS330-CL	-	-	✓	-	CP-W184			-	CP-W124	-	-	-	-	
	-	✓	-	-	CP-W024			-	-	-	-	-	-	
WH-RX830	-	✓	✓	-	-	CP-W1220			CP-WH14 CP-WH14A	-	-	-	-	
WH-RX31	-	✓	✓	-	-	CP-W122			-	-	-	-	-	
WH-RS100	-	✓	✓	-	-	CP-WH24			CP-FH53	-	-	-	-	
WH-RS010-CL	-	✓	✓	-	-	CP-WH24			CP-FH53	-	-	-	-	
WH-R501 WH-R501-A	✓	✓	-	-	CP-FH06	CP-FH31	CP-FH46	CP-WH24	-	-	-	-	-	
	-	-	✓	-	CP-FH08	-	-	CP-WH12	-	-	-	-	-	
WH-RS170	-	✓	-	-	CP-FH40 CP-FH41	-	CP-FH40 CP-FH41	CP-WH12	CP-WH12	-	-	-	-	
	-	-	✓	-	CP-FH08	-	-	CP-WH12	-	-	-	-	-	
WH-RS171 (700c/650b)	-	✓	-	-	CP-FH40 CP-FH41	-	CP-FH40 CP-FH41	CP-WH12	CP-WH12	-	-	-	-	
	-	-	✓	-	CP-FH08	-	-	CP-WH12	-	-	-	-	-	
WH-RX010-CL	-	✓	-	-	CP-FH40 CP-FH41	-	CP-FH40 CP-FH41	CP-WH12	CP-WH12	-	-	-	-	
	✓	✓	-	-	CP-FH08	-	CP-FH40 CP-FH41	CP-WH12	-	-	-	-	-	
WH-U5000	-	✓	✓	-	-	CP-W122			-	-	-	-	-	
WH-RS370	-	✓	✓	-	-	CP-WH12			-	-	-	-	-	
	-	✓	-	-	CP-WH41			CP-WH12	-	-	-	-	-	
WH-RX880 (HG spline L2)	-	-	-	✓	-	-			CP-WRX8A			-		
WH-RX870	-	-	✓	✓	-	-	-	-	-	CP-WH30	-	CP-WH26	-	
WH-RX570	-	✓	✓	-	-	CP-WH30			-	-	-	-	-	
	-	✓	-	-	CP-WH41			CP-WH12	-	-	-	-	-	

\* For compact crank set

\*\* 11-speed : CS-R9100 / CS-R8000 / CS-R7000 / CS-6800 / CS-5800

# Spoke protector for Road

C-302

Speed	Model No.	Number of largest sprocket teeth										Spoke holes number			
		21T	23T	24T	25T	26T	27T	28T	30T	32T	34T	24H	28H	32H	36H
8, 9, 10	Road	✓	✓	-	✓	-	-	-	-	-	-	CP-FH06	CP-FH08	CP-FH05	CP-FH06
		-	-	-	-	✓	-	-	-	-	-	CP-FH31	CP-FH08	CP-FH35	CP-FH31
		-	-	-	-	-	✓	✓	-	-	-	CP-FH31	CP-FH08	CP-FH35	CP-FH31
		-	-	-	-	-	-	-	✓	-	-	-	-	CP-FH45	CP-FH46
7	CS-HG200-7	-	-	-	-	-	-	✓	-	-	-	-	CP-FH35	CP-FH50	
	MF-TZ500-7 MF-TZ510-7	-	-	-	-	-	-	✓	-	-	-	-	-	CP-HG22/ MF-TZ500-7-CP/ MF-TZ21-CP	
	MF-TZ21	-	-	-	-	-	-	✓	-	-	-	-	-	-	

Spoke protector is not available for Road 11-speed FREEHUB.

## E-BIKE system compatibility chart

C-525

### Compatibility chart of E-TUBE PROJECT Cyclist/Professional v5.2.0

#### SHIMANO STEPS with Gen.2 Battery Management System

This is a compatibility table when using the following batteries.

- SHIMANO STEPS Gen.2 battery
- Battery with hardware and firmware compatible with Gen.2 made by partner manufacturers.

\* Gen.2 battery management system is not compatible with a battery with hardware and firmware compatible with conventional system made by partner manufacturers.

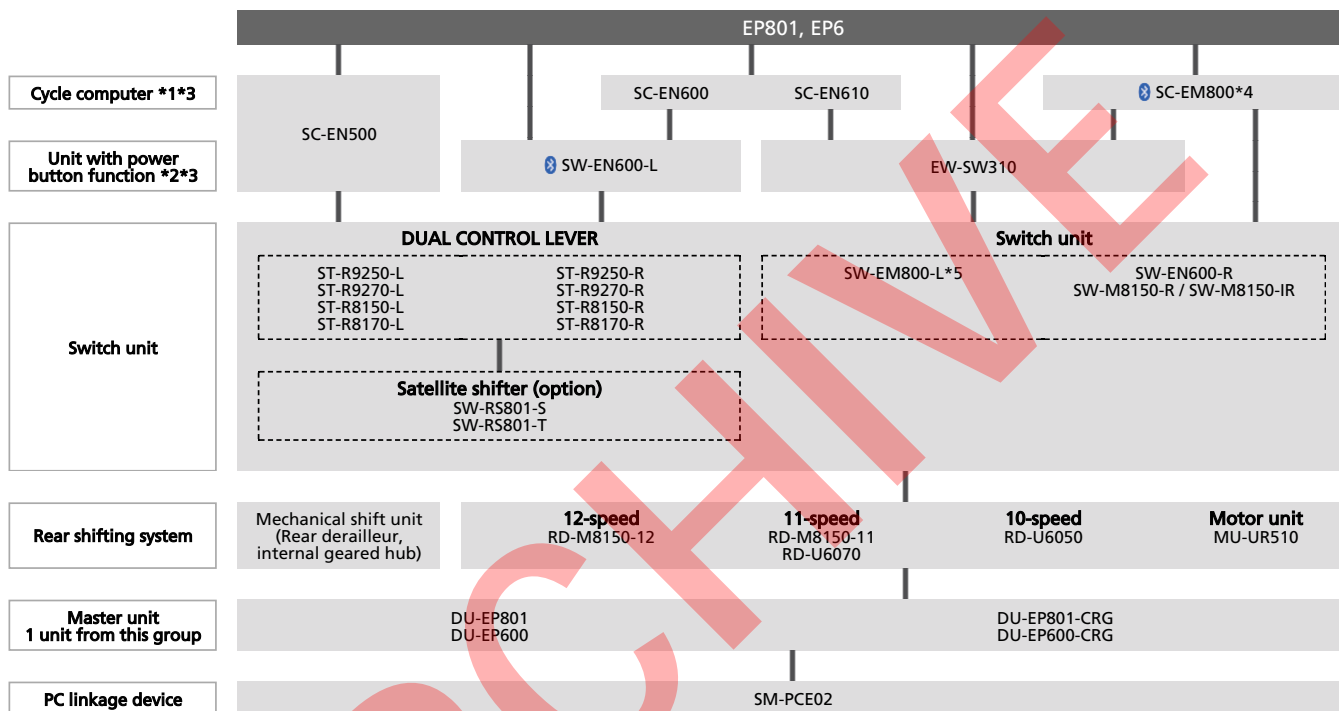

#### Limitation of function

- \*1 When system has unit with power button function, cycle computer isn't mandatory.
- \*2 When the cycle computer, switch unit, and other units has power ON / OFF function, the unit with power button function isn't mandatory.
- \*3 When system has 3rd party CAN cycle computer, SHIMANO cycle computer and the unit with power button function isn't mandatory.
- \*4 When drive unit (US class 3) is connected, cycle computer can displays main screen (speed and assist bar) only.
- \*5 Need to change switch setting by E-TUBE PROJECT to use as shift switch.

## SHIMANO STEPS with 1st generation Battery Management System (for 3rd party battery \*)

\* This is a compatibility table when using a battery made by a partner manufacturer that ensures compatibility only by updating the firmware.

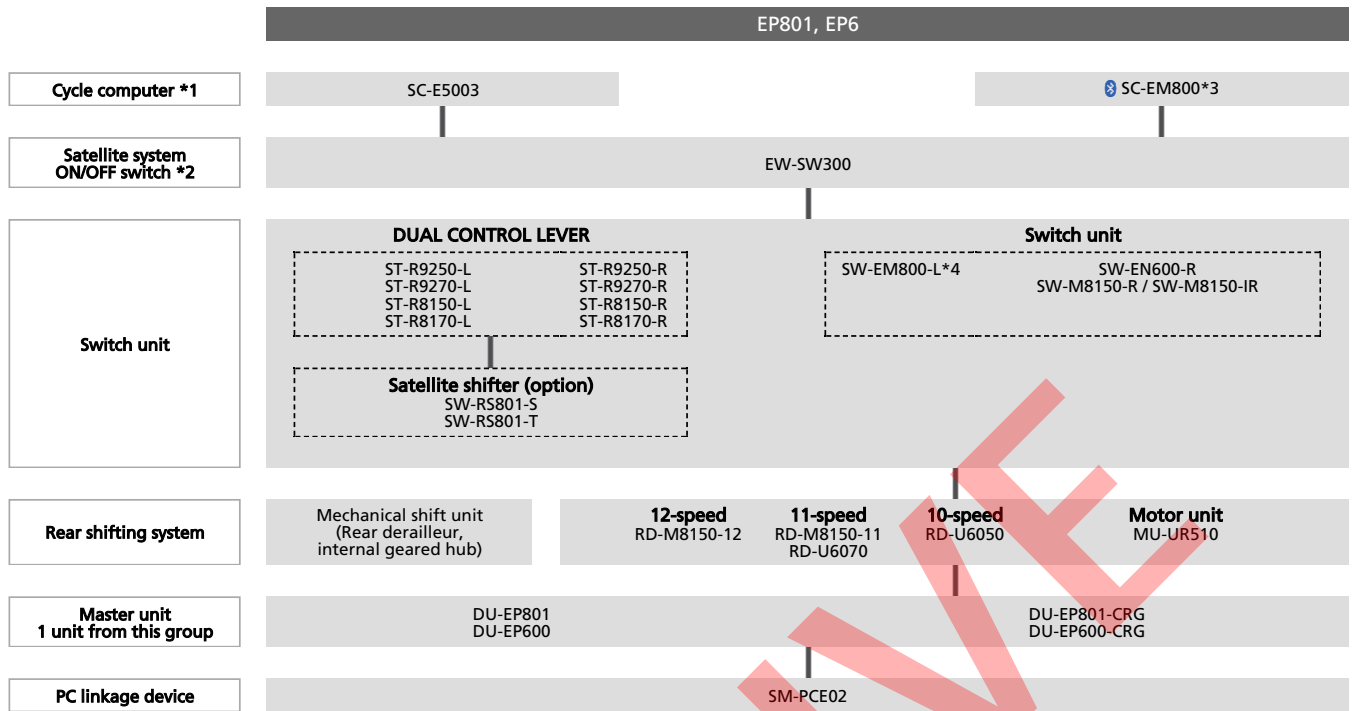

### Limitation of function

- \*1 Cycle computer is mandatory.
- \*2 When power on/off function on other unit, satellite power on/off switch isn't mandatory.
- \*3 When drive unit (US class 3) is connected, cycle computer can displays main screen (speed and assist bar) only.
- \*4 Need to change Switch setting by E-TUBE PROJECT to use as shift switch.

# SHIMANO STEPS with 1st generation Battery Management System (SHIMANO 1st generation battery and compatible 3rd party battery \*)

\* This is a compatibility table when using the following batteries.

- SHIMANO STEPS 1st generation battery
- Battery with hardware and firmware compatible with conventional system made by partner manufacturers.

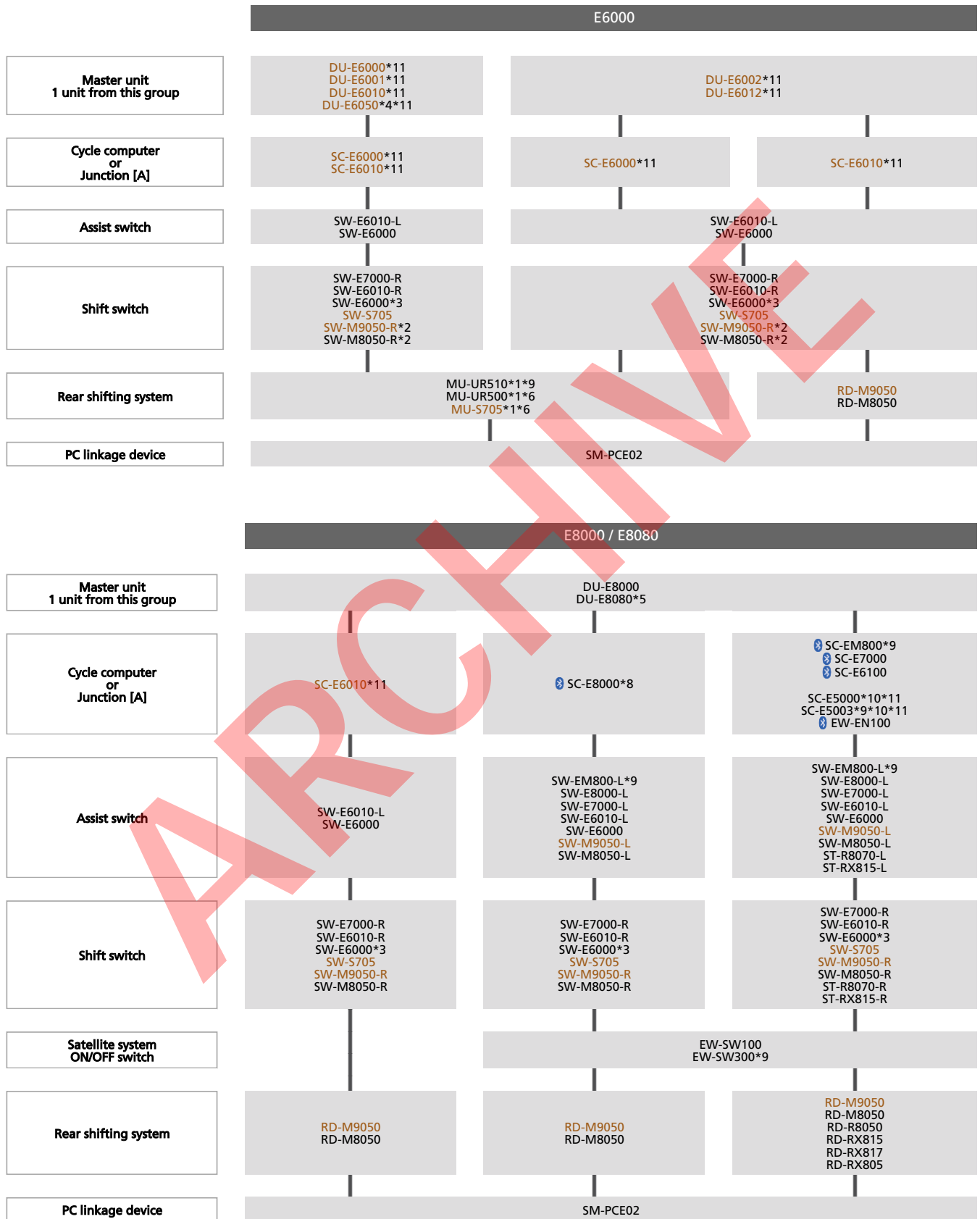

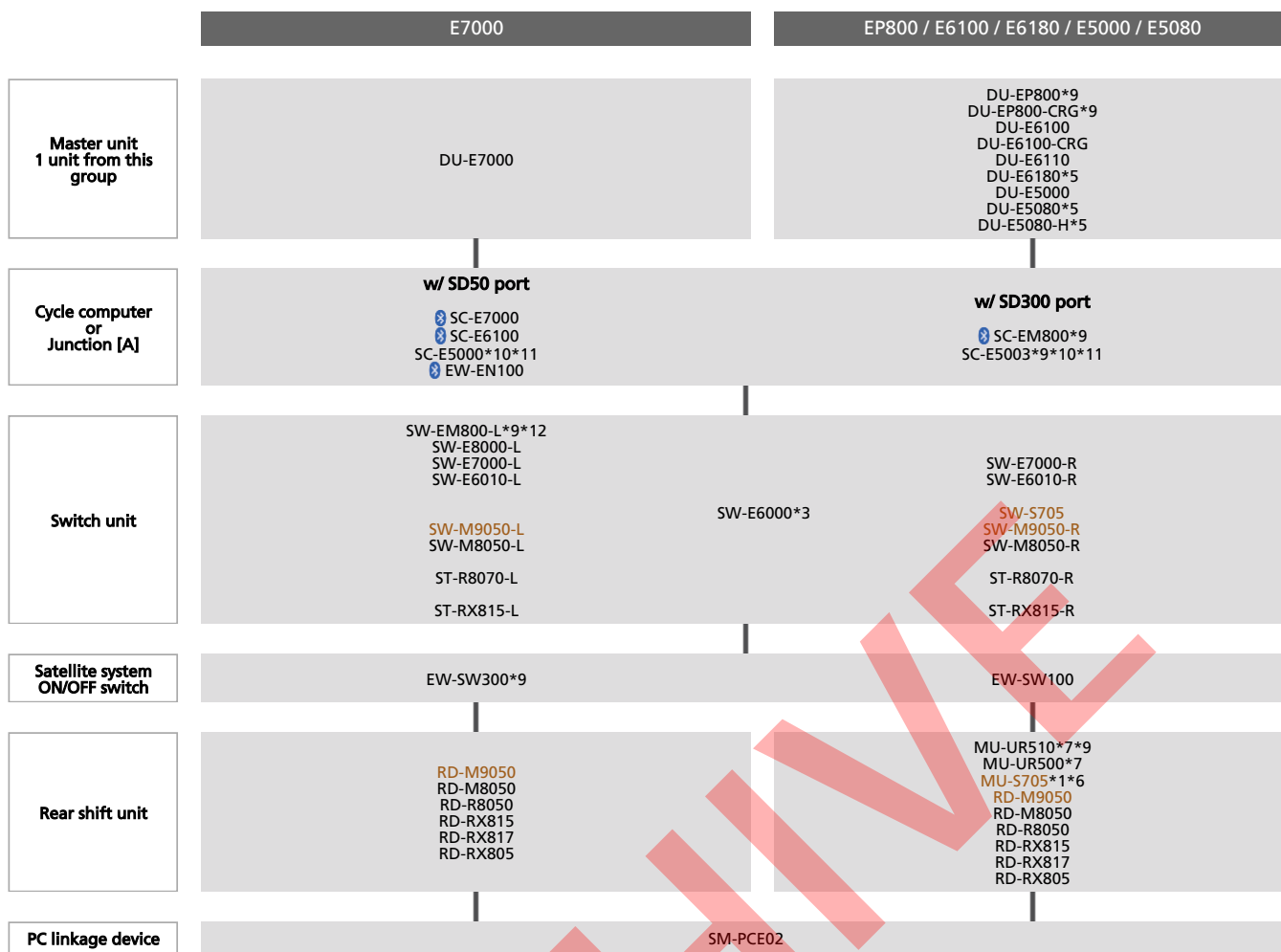

## Limitation of function

- \*1 Fully automatic gear shifting is available only with 8-speed internal geared hubs (Not available with rear derailleurs).
- \*2 Not support full automatic shift.
- \*3 Need to change Switch setting by E-TUBE PROJECT.
- \*4 North American market only.
- \*5 Japanese market only.
- \*6 Available only with 11-speed and 8-speed internal geared hubs.
- \*7 Full automatic shift is available only with 8-speed and 5-speed internal geared hub system. (Not available with Rear Derailleur)
- \*8 Not available in Japan market.
- \*9 This unit has SD300 port, and needs EW-AD305 for connection with SD50 port unit.
- \*10 SC-E5000, SC-E5003 is only for ø22.2 handlebar. Drop handlebar is unavailable.
- \*11 Not supported by E-TUBE PROJECT Cyclist.
- \*12 To use as a shift switch, the switch settings need to be changed in E-TUBE PROJECT.



## DU-EP801 / DU-EP801-CRG / DU-EP800 / DU-EP800-CRG / DU-EP600 / DU-EP600-CRG C-706

### 12-speed Rear derailleur spec.

Shifting system	Chain type	Rear sprocket	Crank arm	Chainring	Chain line (mm)	Chain guard	Chain device
HYPERGLIDE+ 12-speed *2 (Di2, Mechanical)	HG 12-speed	HYPERGLIDE+ 12-speed	FC-EM900 FC-M8150 FC-EM600	SM-CRE80-12-SB 34T/36T	56.5	-	CD-EM800
				CR-EM800 *1 32T	55	-	CD-EM800 w/o plate
				SM-CRE80-12-B 34T/36T/38T			53
				SM-CRE70-12-B 36T	53	-	
				SM-CRE80-12-B 34T/36T/38T			50
				SM-CRE70-12-B 36T	50	-	
				SM-CRE80-R 47T			50
				SM-CRE70-12 42T	Double	-	

\*1 For DU-EP800 and DU-EP800-CRG, it is necessary to replace the lock ring to Y7K79801T

\*2 DU-EP800 and DU-EP800-CRG are not compatible with 12-speed Di2 drivetrain

ARCHIVE

**11/10/9-speed Rear derailleur spec.**

Shifting system	Chain type	Rear sprocket	Crank arm	Chainring	Chain line (mm)	Chain guard	Chain device
LINKGLIDE *1 (Di2, Mechanical)	LINKGLIDE HG 11-speed	LINKGLIDE 11/10/9-speed	FC-EM900 FC-M8150 FC-EM600	SM-CRE80-B 34T/38T	55	-	CD-EM800 (Chain line: 55 mm)
				SM-CRE70-B 34T			
				SM-CRE80-B 34T/38T	53	-	CD-EM800 SM-CDE80 SM-CDE70
				SM-CRE70-B 34T			
				CR-ET600 38T/44T	50	Double	-
				SM-CRE80 34T/38T	50	-	SM-CDE80 w/o plate
				SM-CRE80 44T	50	Double	-
				SM-CRE80-R 47T	50	-	-
				SM-CRE70 38T	50	-	SM-CDE80 w/o plate
				50	Double	-	
HG 11-speed (Di2, Mechanical)	LINKGLIDE HG 11-speed	HG 11-speed	FC-EM900 FC-M8150 FC-EM600	SM-CRE80-B 34T/38T	55	-	CD-EM800 (Chain line: 55 mm)
				SM-CRE70-B 34T			
				SM-CRE80-B 34T/38T	53	-	CD-EM800 SM-CDE80 SM-CDE70
				SM-CRE70-B 34T			
				CR-ET600 38T/44T	50	Double	-
				SM-CRE80 34T/38T	50	-	SM-CDE80 w/o plate
				SM-CRE80 44T	50	Double	-
				SM-CRE80-R 47T	50	-	-
				SM-CRE70 38T	50	-	SM-CDE80 w/o plate
				50	Double	-	
HG 10-speed (Mechanical)	HG 10-speed	HG 10-speed	FC-EM900 FC-M8150 FC-EM600	SM-CRE80-B 34T/38T	55	-	CD-EM800 (Chain line: 55 mm)
				SM-CRE70-B 34T			
				SM-CRE80-B 34T/38T	53	-	CD-EM800 SM-CDE80 SM-CDE70
				SM-CRE70-B 34T			
				CR-ET600 38T/44T	50	Double	-
				SM-CRE80 34T/38T	50	-	SM-CDE80 w/o plate
				SM-CRE80 44T	50	Double	-
				SM-CRE80-R 47T	50	-	-
				SM-CRE70 38T	50	-	SM-CDE80 w/o plate
				50	Double	-	
HG 9-speed (Mechanical)	HG 9-speed	HG 9-speed	FC-EM900 FC-M8150 FC-EM600	SM-CRE70-B 34T	55	-	CD-EM800 (Chain line: 55mm)
				SM-CRE70-B 34T	53		CD-EM800 SM-CDE80 SM-CDE70
				CR-ET600 38T/44T	50	Double	-
				SM-CRE80-R 47T	50	-	-
				SM-CRE70 38T	50	-	SM-CDE80 w/o plate

\*1 DU-EP800 and DU-EP800-CRG are not compatible with LINKGLIDE Di2 drivetrain

**Internal geared hub spec.**

Shifting system	Chain type	Rear sprocket	Crank arm	Chainring	Chain line (mm)	Chain guard	Chain device
ALFINE INTER-11/8 (Di2, Mechanical)	HG 10/9-speed	CS-S500	FC-EM900 FC-M8150 FC-EM600	CR-ET600 38T/44T	50	Double	CT-S510
				SM-CRE61 38T/44T	46.5		
	HG 8-speed	SM-GEAR		CR-ET600 38T/44T	50	Single	
				SM-CRE61 38T/44T	46.5		
				CR-ET600 38T/44T	50	w/o	
SM-CRE61 38T/44T	46.5						
NEXUS INTER-8 (Di2, Mechanical)	HG 10/9-speed	CS-S500	FC-EM900 FC-M8150 FC-EM600	CR-ET600 38T/44T	50	Double	CT-S510
				SM-CRE61 38T/44T	46.5		
	HG 8-speed Single speed (1/2 inch x 1/8 inch)	SM-GEAR		CR-ET600 38T/44T	50	Single	
				SM-CRE61 38T/44T	46.5		
				CR-ET600 38T/44T	50	w/o	
SM-CRE61 38T/44T	46.5						
NEXUS INTER-7/3 (Mechanical)	HG 10/9-speed	CS-S500	FC-EM900 FC-M8150 FC-EM600	CR-ET600 38T/44T	50	Double	CT-S510
				SM-CRE61 38T/44T	46.5		
	HG 8-speed Single speed (1/2 inch x 1/8 inch)	SM-GEAR		CR-ET600 38T/44T	50	Single	
				SM-CRE61 38T/44T	46.5		
				CR-ET600 38T/44T	50	w/o	
SM-CRE61 38T/44T	46.5						
NEXUS INTER-5E (Di2, Mechanical)	HG 9-speed CN-NX10	CS-C7000	FC-EM900 FC-M8150 FC-EM600	CR-ET600 38T/44T	50	Double	CT-S510
				CR-ET600 38T/44T	50	Single	
				SM-CRE61 38T/44T	46.5	w/o	
				CR-ET600 38T/44T	50		
				SM-CRE61 38T/44T	46.5		

**DU-E8000 / DU-E8080 / DU-E7000 C-656**

**12-speed Rear derailleur spec.**

Shifting system	Chain type	Rear sprocket	Crank arm	Chainring	Chain line (mm)	Chain guard	Chain device
HYPERGLIDE+ 12-speed (Mechanical)	HG 12-speed	HYPERGLIDE+ 12-speed	FC-M8050 FC-E8050 FC-E8000	SM-CRE80-12-SB 34T/36T	56.5	-	CD-EM800
				CR-EM800 *1 32T	55	-	CD-EM800 w/o plate
				SM-CRE80-12-B 34T/36T/38T			53
				SM-CRE70-12-B 36T	50	-	
				SM-CRE80-12-B 34T/36T/38T			
				SM-CRE70-12-B 36T			
				SM-CRE80-R 47T	50	Double	-
SM-CRE70-12 42T							

\*1 Necessary to replace the lock ring to Y7K79801T.

11/10/9-speed Rear derailleur spec.

Shifting system	Chain type	Rear sprocket	Crank arm	Chainring	Chain line (mm)	Chain guard	Chain device
LINKGLIDE (Mechanical)	LINKGLIDE	LINKGLIDE	FC-M8050 FC-E8050 FC-E8000	SM-CRE80-B 34T/38T	55	-	CD-EM800 (Chain line: 55 mm)
				SM-CRE70-B 34T			
				SM-CRE80-B 34T/38T	53	-	CD-EM800 SM-CDE80 SM-CDE70
				SM-CRE70-B 34T			
				CR-ET600 38T/44T	50	Double	-
				SM-CRE80 34T/38T		-	SM-CDE80 w/o plate
				SM-CRE80 44T		Double	-
				SM-CRE80-R 47T		-	SM-CDE80 w/o plate
				SM-CRE70 38T		Double	-
HG 11-speed (Di2, Mechanical)	LINKGLIDE HG 11-speed	HG 11-speed	FC-M8050 FC-E8050 FC-E8000	SM-CRE80-B 34T/38T	55	-	CD-EM800 (Chain line: 55 mm)
				SM-CRE70-B 34T			
				SM-CRE80-B 34T/38T	53	-	CD-EM800 SM-CDE80 SM-CDE70
				SM-CRE70-B 34T			
				CR-ET600 38T/44T	50	Double	-
				SM-CRE80 34T/38T		-	SM-CDE80 w/o plate
				SM-CRE80 44T		Double	-
				SM-CRE80-R 47T		-	SM-CDE80 w/o plate
				SM-CRE70 38T		Double	-
HG 10-speed (Mechanical)	HG 10-speed	HG 10-speed	FC-M8050 FC-E8050 FC-E8000	SM-CRE80-B 34T/38T	55	-	CD-EM800 (Chain line: 55 mm)
				SM-CRE70-B 34T			
				SM-CRE80-B 34T/38T	53	-	CD-EM800 SM-CDE80 SM-CDE70
				SM-CRE70-B 34T			
				CR-ET600 38T/44T	50	Double	-
				SM-CRE80 34T/38T		-	SM-CDE80 w/o plate
				SM-CRE80 44T		Double	-
				SM-CRE80-R 47T		-	SM-CDE80 w/o plate
				SM-CRE70 38T		Double	-
HG 9-speed (Mechanical)	HG 9-speed	HG 9-speed	FC-M8050 FC-E8050 FC-E8000	SM-CRE70-B 34T	55	-	CD-EM800 (Chain line: 55 mm)
				SM-CRE70-B 34T	53		CD-EM800 SM-CDE80 SM-CDE70
				CR-ET600 38T/44T	50	Double	-
				SM-CRE80-R 47T	50	-	-
				SM-CRE70 38T	50	-	SM-CDE80 w/o plate
					50	Double	-

# DU-E6100 / DU-E6100-CRG / DU-E6110 / DU-E6180 C-657

## 12-speed Rear derailleur spec.

Shifting system	Chain type	Rear sprocket	Crank arm	Chainring	Chain line (mm)	Chain guard	Chain device
HYPERGLIDE+ 12-speed (Mechanical)	HG 12-speed	HYPERGLIDE+ 12-speed	FC-M8050 FC-E8050 FC-E8000 FC-E6100	SM-CRE80-12-SB 34T/36T	56.5	-	-
				SM-CRE80-12-B 34T/36T/38T	55	-	
				SM-CRE70-12-B 36T		-	
				SM-CRE80-12-B 34T/36T/38T	53	-	
				SM-CRE70-12-B 36T		-	
				SM-CRE80-R 47T	50	-	
				SM-CRE70-12 42T		Double	

## 11/10/9-speed Rear derailleur spec.

Shifting system	Chain type	Rear sprocket	Crank arm	Chainring	Chain line (mm)	Chain guard	Chain device	
LINKGLIDE (Mechanical)	LINKGLIDE	LINKGLIDE	FC-M8050 FC-E8050 FC-E8000 FC-E6100	SM-CRE80-B 34T/38T	55	-	-	
				SM-CRE70-B 34T				
				SM-CRE80-B 34T/38T	53	-		
				SM-CRE70-B 34T				
				CR-ET600 38T/44T	50	Double		
				SM-CRE80 34T/38T		-		
				SM-CRE80 44T		Double		
				SM-CRE80-R 47T		-		
				SM-CRE70 38T		-		
				SM-CRE70 38T		Double		
				SM-CRE61 38T/44T		46.5		Double, Single, w/o
				SM-CRE80-B 34T/38T		55		-
SM-CRE70-B 34T								
SM-CRE80-B 34T/38T	53	-						
SM-CRE70-B 34T								
CR-ET600 38T/44T	50	Double						
SM-CRE80 34T/38T		-						
SM-CRE80 44T		Double						
SM-CRE80-R 47T		-						
SM-CRE70 38T		-						
SM-CRE70 38T		Double						
SM-CRE61 38T/44T		46.5	Double, Single, w/o					

Shifting system	Chain type	Rear sprocket	Crank arm	Chaining	Chain line (mm)	Chain guard	Chain device
HG 10-speed (Mechanical)	LINKGLIDE HG 10-speed	HG 10-speed	FC-M8050 FC-E8050 FC-E8000 FC-E6100	SM-CRE80-B 34T/38T	55	-	-
				SM-CRE70-B 34T			
				SM-CRE80-B 34T/38T	53	-	
				SM-CRE70-B 34T			
				CR-ET600 38T/44T	50	Double	
				SM-CRE80 34T/38T		-	
				SM-CRE80 44T		Double	
				SM-CRE80-R 47T		-	
				SM-CRE70 38T		-	
				SM-CRE70 38T		Double	
				SM-CRE61 38T/44T	46.5	Double, Single, w/o	
HG 9-speed (Mechanical)	LINKGLIDE HG 9-speed	HG 9-speed	FC-M8050 FC-E8050 FC-E8000 FC-E6100	SM-CRE80-B 34T/38T	55	-	-
				SM-CRE70-B 34T			
				SM-CRE80-B 34T/38T	53	-	
				SM-CRE70-B 34T			
				CR-ET600 38T/44T	50	Double	
				SM-CRE80 34T/38T		-	
				SM-CRE80 44T		Double	
				SM-CRE80-R 47T		-	
				SM-CRE70 38T		-	
				SM-CRE70 38T		Double	
				SM-CRE61 38T/44T	46.5	Double, Single, w/o	

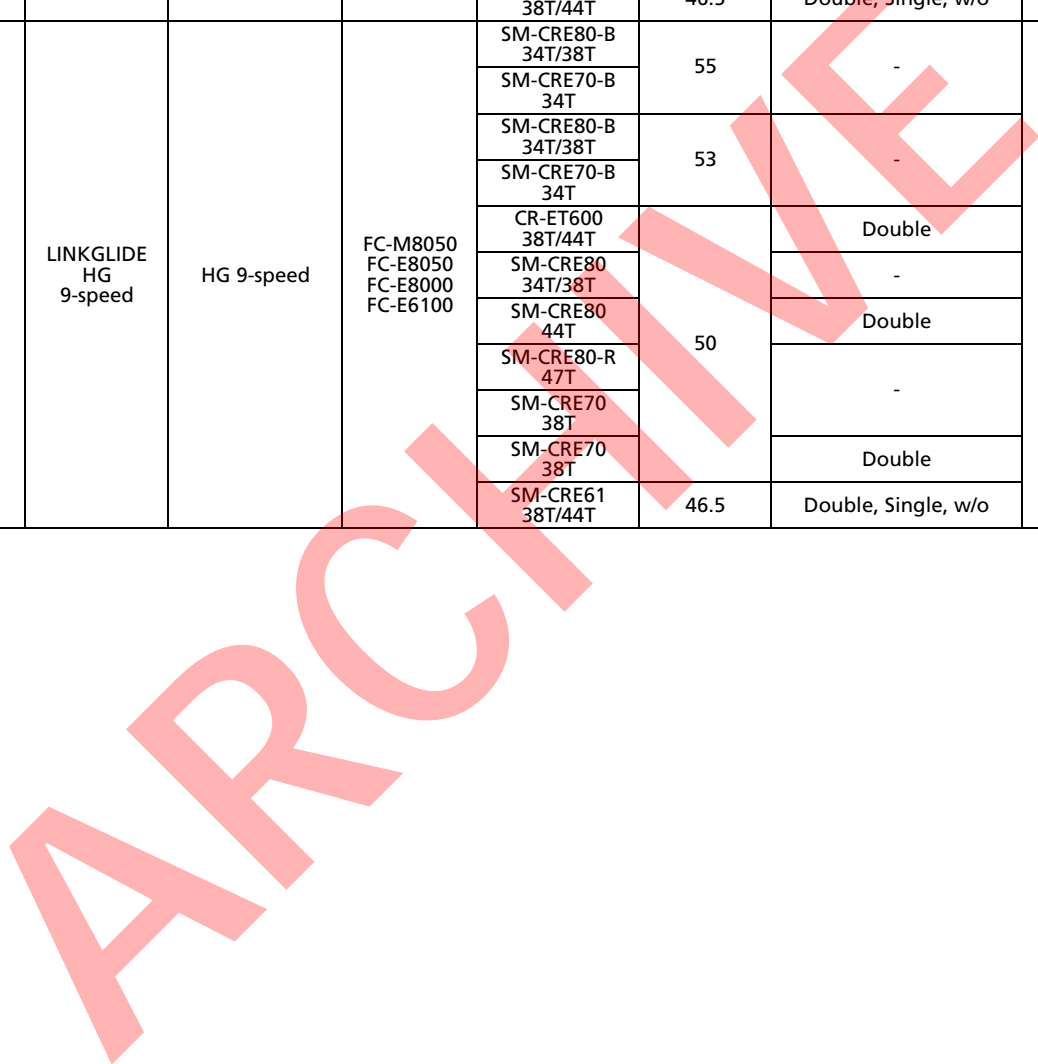

**Internal geared hub spec.**

Shifting system	Chain type	Rear sprocket	Crank arm	Chainring	Chain line (mm)	Chain guard	Chain tensioner
ALFINE INTER-11/8 (Di2, Mechanical)	HG 10/9-speed	CS-S500	FC-M8050 FC-E8050 FC-E8000 FC-E6100	CR-ET600 38T/44T	50	Double	CT-S510
				SM-CRE61 38T/44T	46.5		
	HG 8-speed	SM-GEAR		CR-ET600 38T/44T	50	Single	
				SM-CRE61 38T/44T	46.5		
				CR-ET600 38T/44T	50	w/o	
SM-CRE61 38T/44T	46.5						
NEXUS INTER-8 (Di2, Mechanical)	HG 10/9-speed	CS-S500	FC-M8050 FC-E8050 FC-E8000 FC-E6100	CR-ET600 38T/44T	50	Double	CT-S510
				SM-CRE61 38T/44T	46.5		
	HG 8-speed Single speed 1/2 inch x 1/8 inch	SM-GEAR		CR-ET600 38T/44T	50	Single	
				SM-CRE61 38T/44T	46.5		
				CR-ET600 38T/44T	50	w/o	
SM-CRE61 38T/44T	46.5						
NEXUS INTER-7/3 (Mechanical)	HG 10/9-speed	CS-S500	FC-M8050 FC-E8050 FC-E8000 FC-E6100	CR-ET600 38T/44T	50	Double	CT-S510
				SM-CRE61 38T/44T	46.5		
	HG 8-speed Single speed 1/2 inch x 1/8 inch	SM-GEAR		CR-ET600 38T/44T	50	Single	
				SM-CRE61 38T/44T	46.5		
				CR-ET600 38T/44T	50	w/o	
SM-CRE61 38T/44T	46.5						
NEXUS INTER-5E (Di2, Mechanical)	HG 9-speed CN-NX10	CS-C7000	FC-M8050 FC-E8050 FC-E8000 FC-E6100	CR-ET600 38T/44T	50	Double	CT-S510
				CR-ET600 38T/44T	50	Single	
				SM-CRE61 38T/44T	46.5	w/o	
				CR-ET600 38T/44T	50		
				SM-CRE61 38T/44T	46.5		

ARCHIVE

# DU-E6000 / DU-E6001 / DU-E6010 / DU-E6050 C-658

## 11/10/9-speed Rear derailleur spec.

Shifting system	Chain type	Rear sprocket	Crank arm	Chainring	Chain line (mm)	Chain guard	Chain tensioner
HG 11-speed (Mechanical)	HG 11-speed	HG 11-speed	FC-E6000 FC-E6010 FC-E5000 FC-E5010	SM-CRE60 38T/44T	46.5	Double	-
HG 10-speed (Mechanical)	HG 10-speed	HG 10-speed		SM-CRE60 38T/44T	46.5	Double	-
HG 9-speed (Mechanical)	HG 9-speed	HG 9-speed		SM-CRE60 38T/44T	46.5	Double	-

## Internal geared hub spec.

Shifting system	Chain type	Rear sprocket	Crank arm	Chainring	Chain line (mm)	Chain guard	Chain tensioner
ALFINE INTER-11/8 (Di2, Mechanical)	HG 9/8-speed	CS-S500	FC-E6000 FC-E6010 FC-E5000 FC-E5010	SM-CRE60 38T/44T	46.5	w/o	CT-S510
		SM-GEAR		SM-CRE60 38T/44T	46.5	Double	
NEXUS INTER-8 (Di2, Mechanical)	HG Single speed (1/2 inch x 1/8 inch)	SM-GEAR		SM-CRE60 38T/44T	46.5	Single, w/o	CT-S510 *
NEXUS INTER-7/3 (Mechanical)	HG Single speed (1/2 inch x 1/8 inch)	SM-GEAR		SM-CRE60 38T/44T	46.5	Single, w/o	
NEXUS INTER-5E (Di2, Mechanical)	HG 8/7/6-speed	CS-C7000		SM-CRE60 38T/44T	46.5	Double	-

\* Not compatible with CN-NX10

# DU-E5000 / DU-E5080 / DU-E5080-H C-659

## 11/10/9-speed Rear derailleur spec.

Shifting system	Chain type	Rear sprocket	Crank arm	Chainring	Chain line (mm)	Chain guard	Chain device
LINKGLIDE (Mechanical)	LINKGLIDE	LINKGLIDE	FC-E6000 FC-E6010 FC-E5000 FC-E5010	SM-CRE50 38T/44T	46.5	Double, Single, w/o	-
HG 11-speed (Di2, Mechanical)	HG 11-speed	HG 11-speed		SM-CRE50 38T/44T	46.5	Double, Single, w/o	
HG 10-speed (Mechanical)	HG 10-speed	HG 10-speed		SM-CRE50 38T/44T	46.5	Double, Single, w/o	
HG 9-speed (Mechanical)	HG 9-speed	HG 9-speed		SM-CRE50 38T/44T	46.5	Double, Single, w/o	

## Internal geared hub spec.

Shifting system	Chain type	Rear sprocket	Crank arm	Chainring	Chain line (mm)	Chain guard	Chain device
ALFINE INTER-11/8 (Di2, Mechanical)	HG 10/9-speed	CS-S500	FC-E6000 FC-E6010 FC-E5000 FC-E5010	SM-CRE50 38T/44T	46.5	Double	CT-S510
	HG 8-speed	SM-GEAR		SM-CRE50 38T/44T		Single	
				SM-CRE50 38T/44T		w/o	
NEXUS INTER-8 (Di2, Mechanical)	HG 10/9-speed	CS-S500		SM-CRE50 38T/44T	46.5	Double	CT-S510
	HG 8-speed Single speed (1/2 inch x 1/8 inch)	SM-GEAR		SM-CRE50 38T/44T		Single	
				SM-CRE50 38T/44T		w/o	
NEXUS INTER-7/3 (Mechanical)	HG 10/9-speed	CS-S500		SM-CRE50 38T/44T	46.5	Double	CT-S510
	HG Single speed (1/2 inch x 1/8 inch)	SM-GEAR		SM-CRE50 38T/44T		Single	
				SM-CRE50 38T/44T		w/o	
NEXUS INTER-5E (Di2, Mechanical)	HG 8-speed CN-NX10	CS-C7000		SM-CRE50 38T/44T	46.5	Single, w/o	-



# Switch unit / cycle computer and brake lever compatibility

C-421

## For Hydraulic Disc brake

### I-SPEC EV type brake lever

Model No.	Di2 shift switch			SHIMANO STEPS cycle computer		
	SW-M9050	SW-M8050	SW-M8150-IR	SC-E5000 *2	SC-E5003 *2	SC-EN500 *2
BL-M9100 *1	-	-	✓	✓	-	✓
BL-M9120 *1	-	-	✓	✓	-	✓
BL-M8100 *1	-	-	✓	✓	-	✓
BL-M7100 *1	-	-	✓	✓	-	✓
BL-M6100	-	-	✓	✓	-	✓
BL-M4100	-	-	✓	✓	-	✓

Model No.	SHIMANO STEPS switch unit						
	SW-EM800-L	SW-E8000-L	SW-E7000	SW-E6010	SW-E6000	SW-EN600-L	SW-EN600-R
BL-M9100 *1	✓	-	✓	✓	✓	✓	✓
BL-M9120 *1	✓	-	✓	✓	✓	✓	✓
BL-M8100 *1	✓	-	✓	✓	✓	✓	✓
BL-M7100 *1	✓	-	✓	✓	✓	✓	✓
BL-M6100	✓	-	✓	✓	✓	✓	✓
BL-M4100	✓	-	✓	✓	✓	✓	✓

\*1: In case of using these brake lever, refer to [C-422](#).

\*2: I-SPEC EV compatible spec only.

### I-SPEC II type brake lever

Model No.	Di2 shift switch			SHIMANO STEPS cycle computer		
	SW-M9050	SW-M8050	SW-M8150-R	SC-E5000	SC-E5003	SC-EN500
BL-M9000 *1	✓	✓	✓	✓	✓	✓
BL-M9020 *1	✓	✓	✓	✓	✓	✓
BL-M8000 *1	✓	✓	✓	✓	✓	✓
BL-T8100 *1	✓	✓	✓	✓	✓	✓
BL-T8000 *1	✓	✓	✓	✓	✓	✓
BL-M7000 *1	✓	✓	✓	✓	✓	✓
BL-M6000	✓	✓	✓	✓	✓	✓
BL-T6000	✓	✓	✓	✓	✓	✓
BL-RS600	✓	✓	✓	✓	✓	✓
BL-MT501	✓	✓	✓	✓	✓	✓
BL-U8000 *2	-	-	✓	✓	✓	✓

Model No.	SHIMANO STEPS switch unit						
	SW-EM800-L	SW-E8000-L	SW-E7000	SW-E6010	SW-E6000	SW-EN600-L	SW-EN600-R
BL-M9000 *1	✓	✓	✓	✓	✓	✓	✓
BL-M9020 *1	✓	✓	✓	✓	✓	✓	✓
BL-M8000 *1	✓	✓	✓	✓	✓	✓	✓
BL-T8100 *1	✓	✓	✓	✓	✓	✓	✓
BL-T8000 *1	✓	✓	✓	✓	✓	✓	✓
BL-M7000 *1	✓	✓	✓	✓	✓	✓	✓
BL-M6000	✓	✓	✓	✓	✓	✓	✓
BL-T6000	✓	✓	✓	✓	✓	✓	✓
BL-RS600	✓	✓	✓	✓	✓	✓	✓
BL-MT501	✓	✓	✓	✓	✓	✓	✓
BL-U8000 *2	✓	-	✓	✓	✓	✓	✓

\*1: In case of using these brake lever, refer to [C-422](#).

\*2: As for the compatibility between [BL-U8000](#) and mechanical shift lever, please refer to the [C-738](#).

## Other clamp band type brake lever

Model No.	Di2 shift switch			SHIMANO STEPS cycle computer		
	SW-M9050	SW-M8050	SW-M8150-R	SC-E5000	SC-E5003	SC-EN500
BL-MT402-3A	✓	✓	✓	✓	✓	✓
BL-MT401	✓	✓	✓	✓	✓	✓
BL-MT201	✓	✓	✓	✓	✓	✓
BL-MT200	✓	✓	✓	✓	✓	✓

Model No.	SHIMANO STEPS switch unit						
	SW-EM800-L	SW-E8000-L	SW-E7000	SW-E6010	SW-E6000	SW-EN600-L	SW-EN600-R
BL-MT402-3A	✓	✓	✓	✓	✓	✓	✓
BL-MT401	✓	✓	✓	✓	✓	✓	✓
BL-MT201	✓	✓	✓	✓	✓	✓	✓
BL-MT200	✓	✓	✓	✓	✓	✓	✓

## Brake lever for mechanical brake (Mechanical disc brake / V-BRAKE / Caliper brake / Cantilever brake)

Refer to Spec Hand Book for compatible brake type.

Model No.	SHIMANO STEPS cycle computer		
	SC-E5000	SC-E5003	SC-EN500
BL-T610	✓	✓	✓
BL-T611	✓	✓	✓
BL-T4000	✓	✓	✓
BL-T4010	✓	✓	✓
BL-C6010	✓	✓	✓
BL-4700	✓	✓	✓
BL-R3000	✓	✓	✓
BL-R2000	✓	✓	✓
BL-R780	✓	✓	✓
BL-R550	✓	✓	✓

Model No.	SHIMANO STEPS switch unit						
	SW-EM800-L	SW-E8000-L	SW-E7000	SW-E6010	SW-E6000	SW-EN600-L	SW-EN600-R
BL-T610	✓	✓	✓	✓	✓	✓	✓
BL-T611	✓	✓	✓	✓	✓	✓	✓
BL-T4000	✓	✓	✓	✓	✓	✓	✓
BL-T4010	✓	✓	✓	✓	✓	✓	✓
BL-C6010	✓	✓	✓	✓	✓	✓	✓
BL-4700	✓	✓	✓	✓	✓	✓	✓
BL-R3000	✓	✓	✓	✓	✓	✓	✓
BL-R2000	✓	✓	✓	✓	✓	✓	✓
BL-R780	✓	✓	✓	✓	✓	✓	✓
BL-R550	✓	✓	✓	✓	✓	✓	✓

## Battery

Batteries shipped in the country / region are different.

### For Gen.2 battery management system

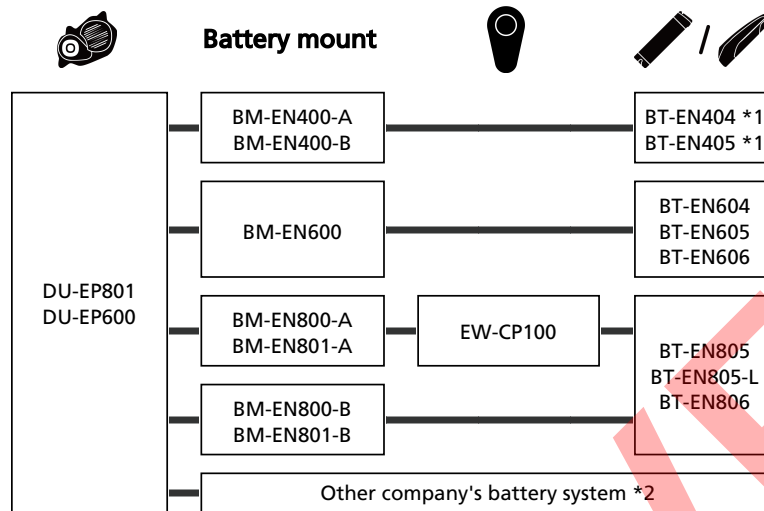

### Limitation of function

\*1 These batteries don't support over 500W drive unit power output

\*2 Some of these batteries don't support over 500W drive unit power output

For 1st generation battery management system

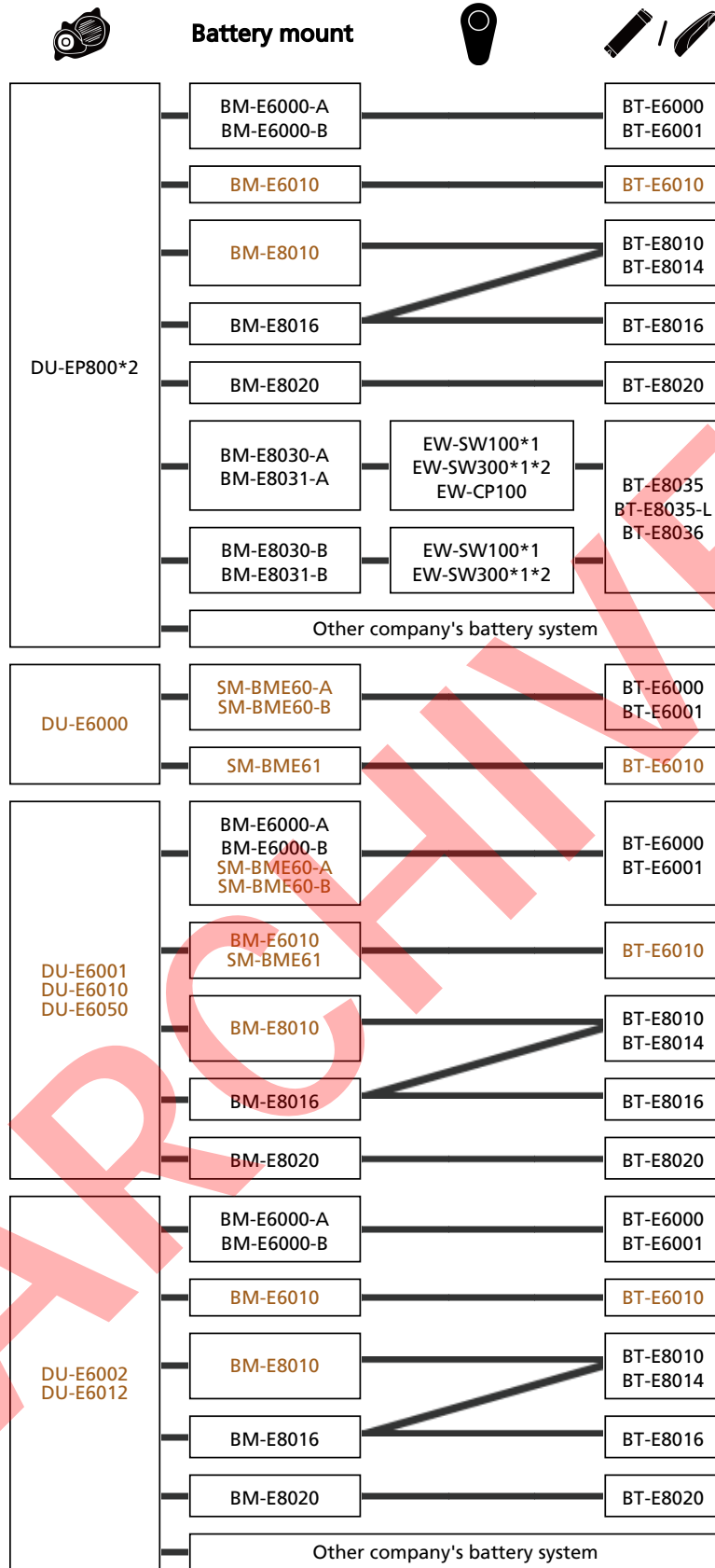

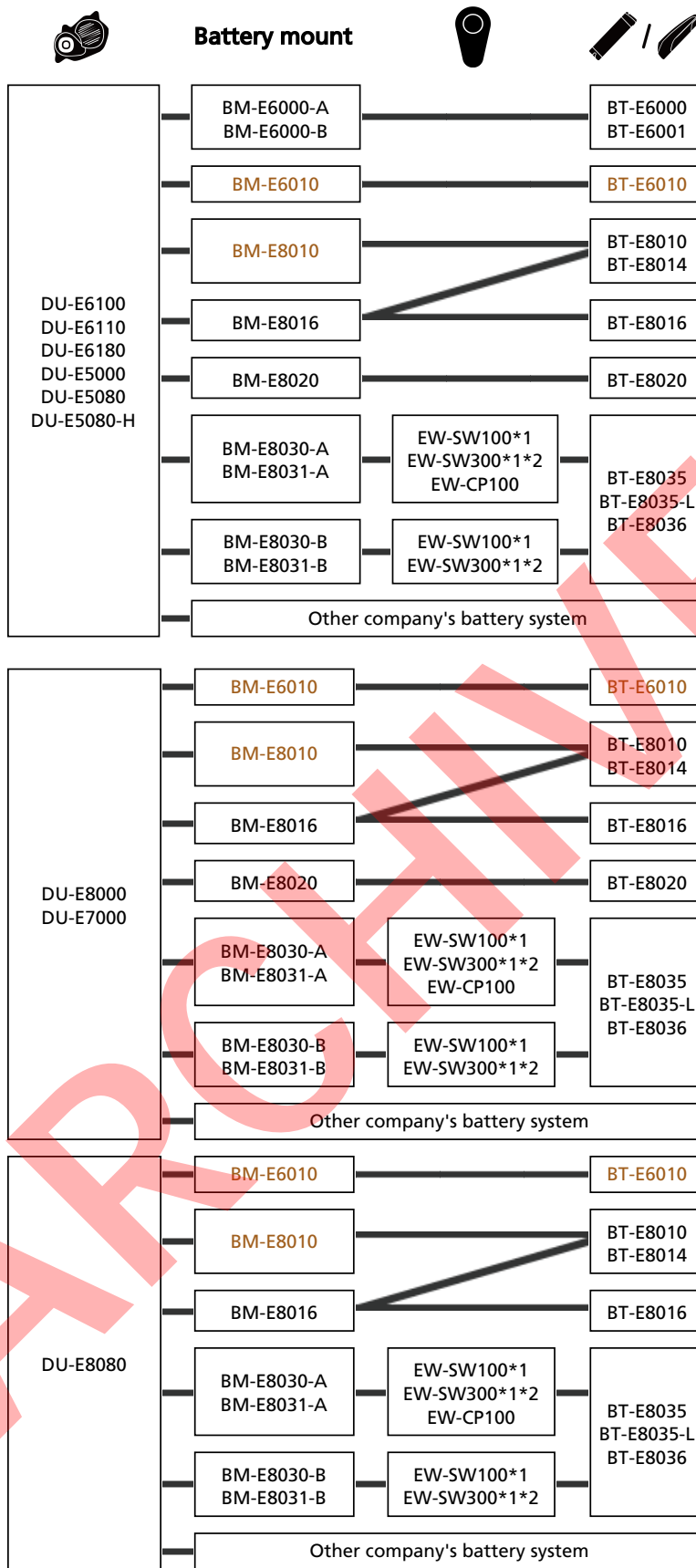

### Limitation of function

\*1: Can't use with SC-E6010

\*2: This unit has SD300 port, and needs EW-AD305 for connection to SD50 port unit.

## External frame mount type

### MTB, URBAN, Trekking use

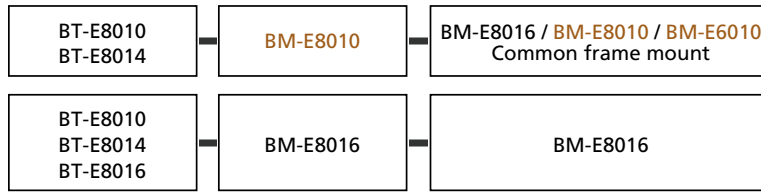

## Built-in frame mount type

### MTB, URBAN, Trekking use

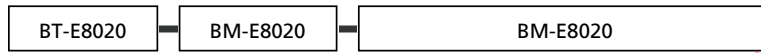

### ROAD, MTB, URBAN, Trekking use

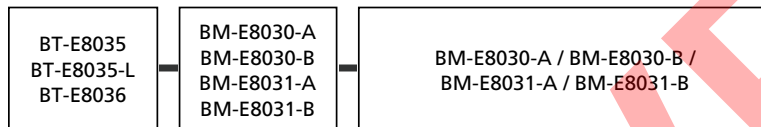

ARCHIVE

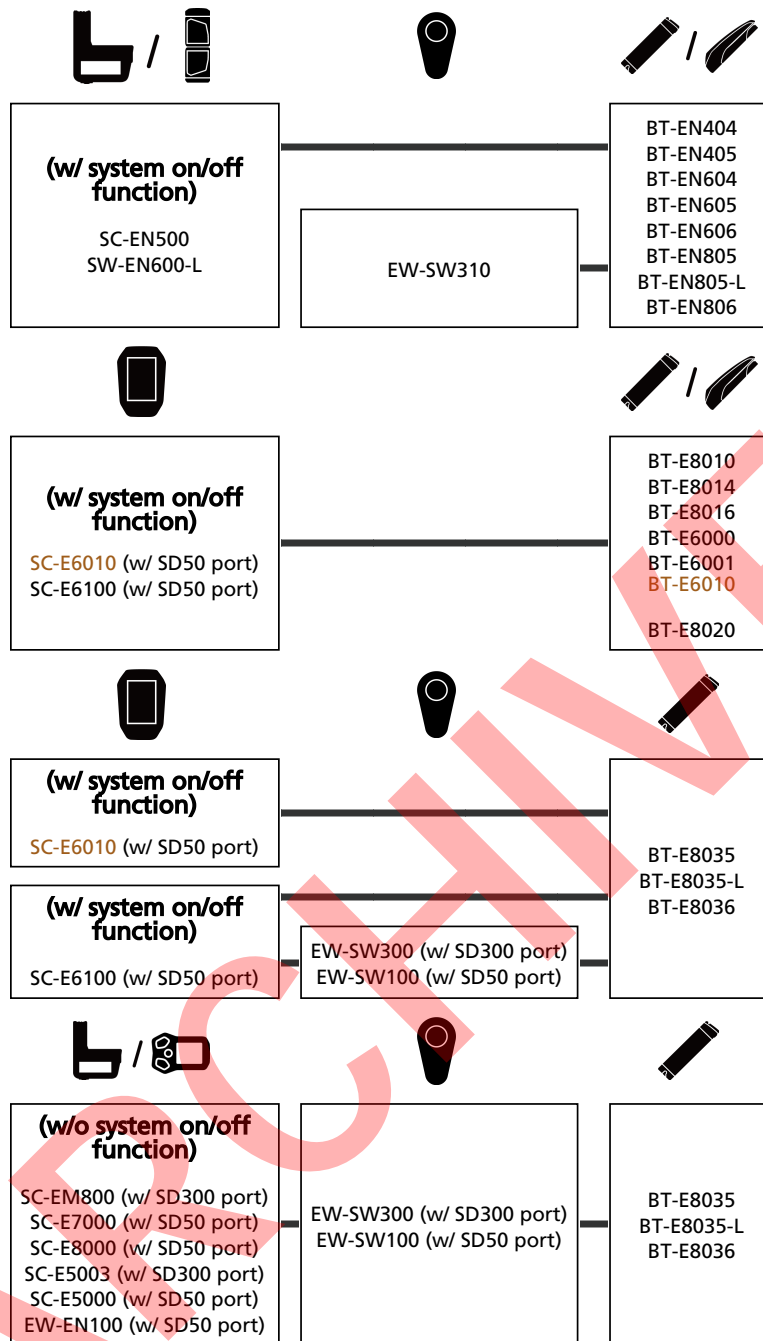

## Speed sensor

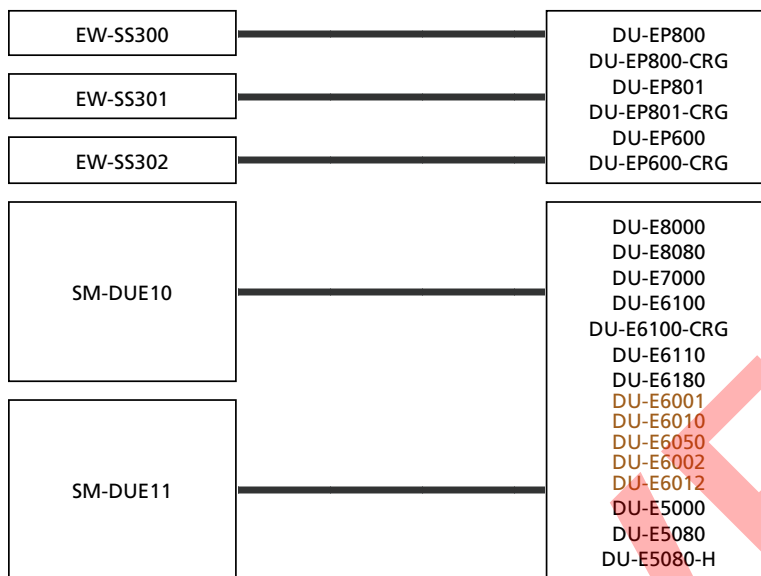

ARCHIVE



# Battery and battery charger compatibility

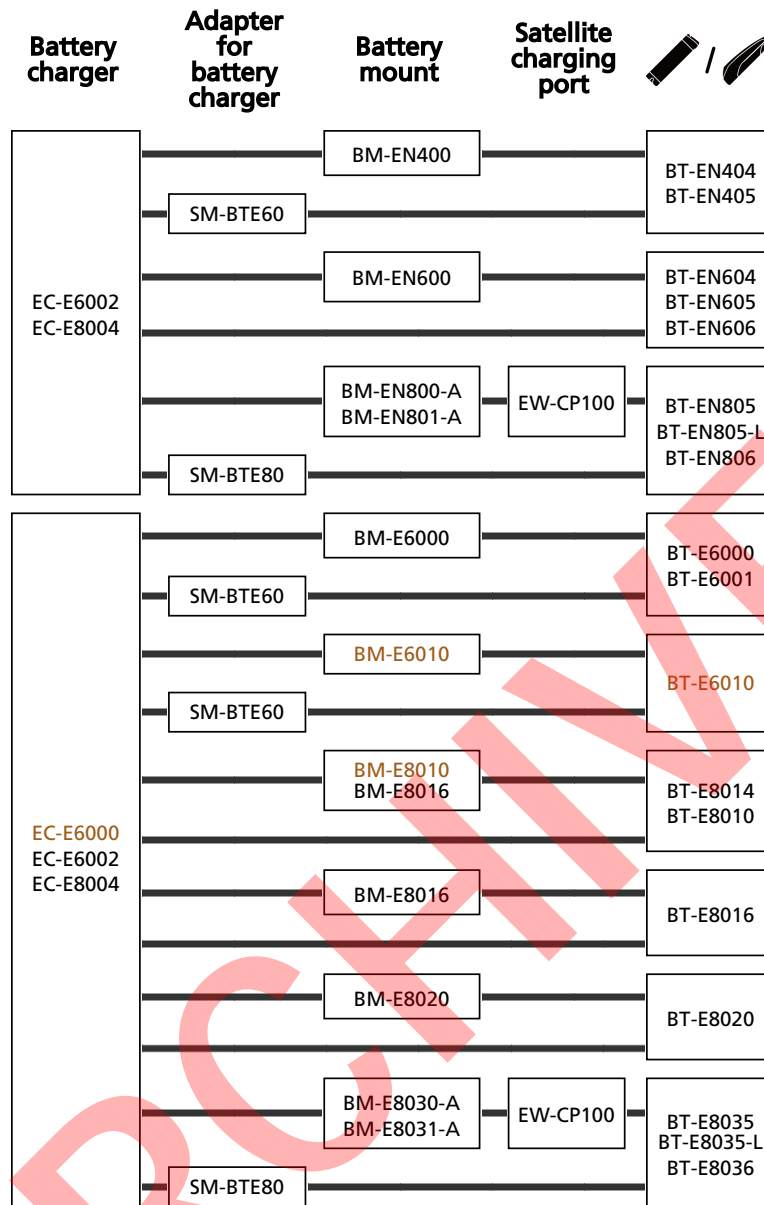

## ABS main unit and drive unit compatibility

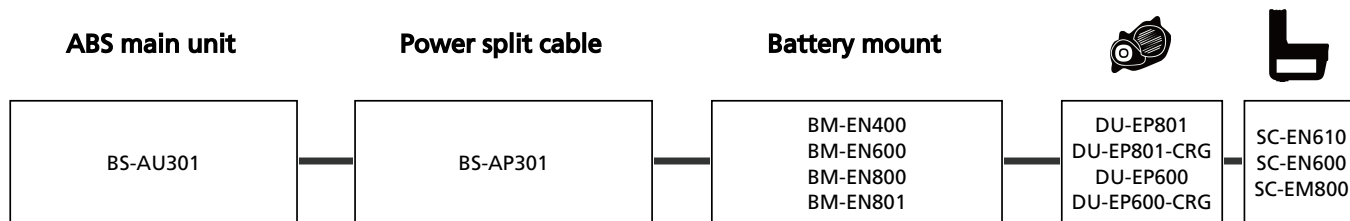

## Wheel speed sensor and disc brake rotor compatibility

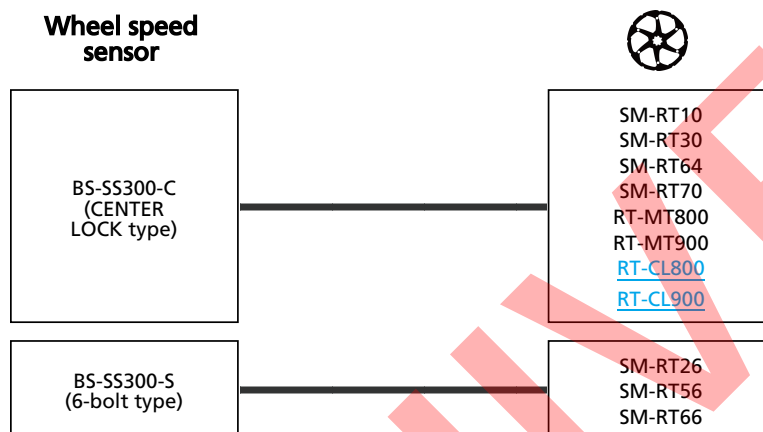

## E-TUBE compatibility chart

C-473

### Compatibility chart of E-TUBE PROJECT Cyclist/Professional v5.2.0

#### Di2 with BT-DN300

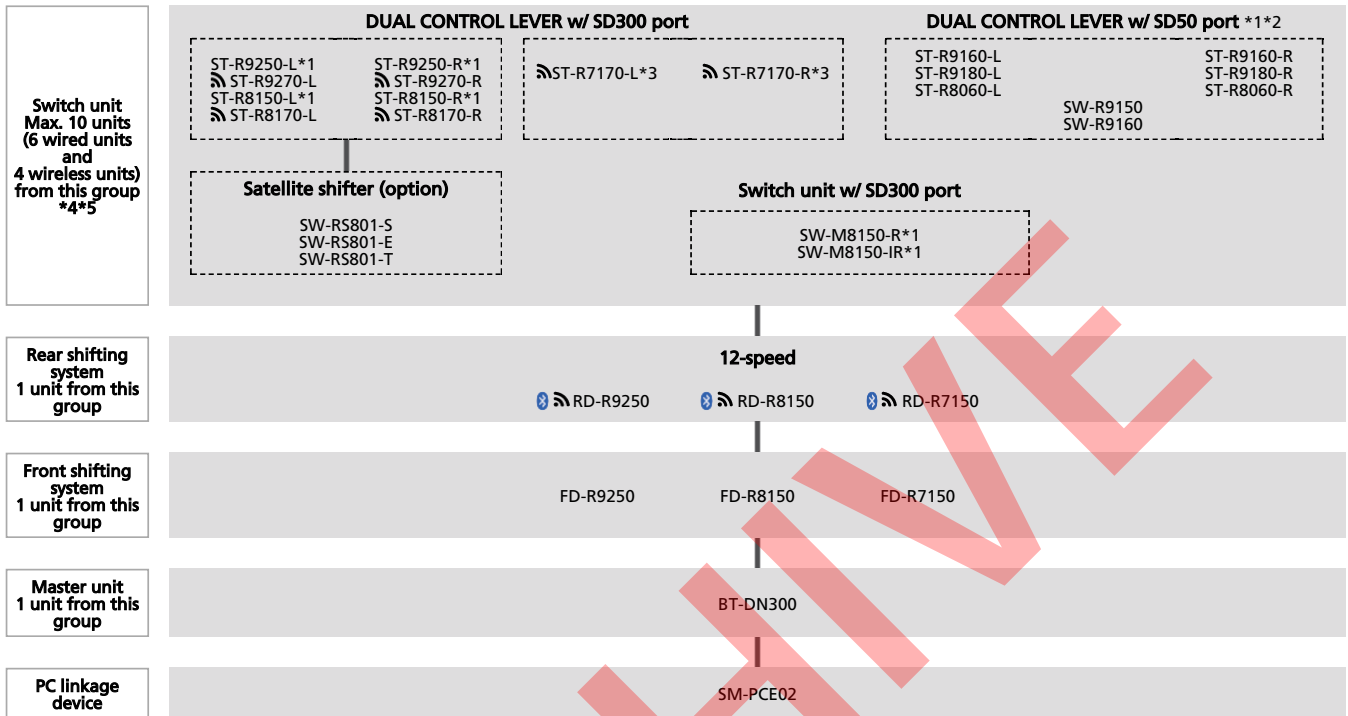

#### Limitation of function with BT-DN300

- \*1 Wired connection to BT-DN300 only
- \*2 EW-AD305 is needed
- \*3 Wireless connection only
- \*4 Wireless DUAL CONTROL LEVERs must be paired Right and Left (It's not allowed to choose two of right side units or 2 of left side units)
- \*5 There is no limitation to connect switch unit for right side or left side unit in case of it's wired connection

# Di2 with BM-DN100 / BT-DN110

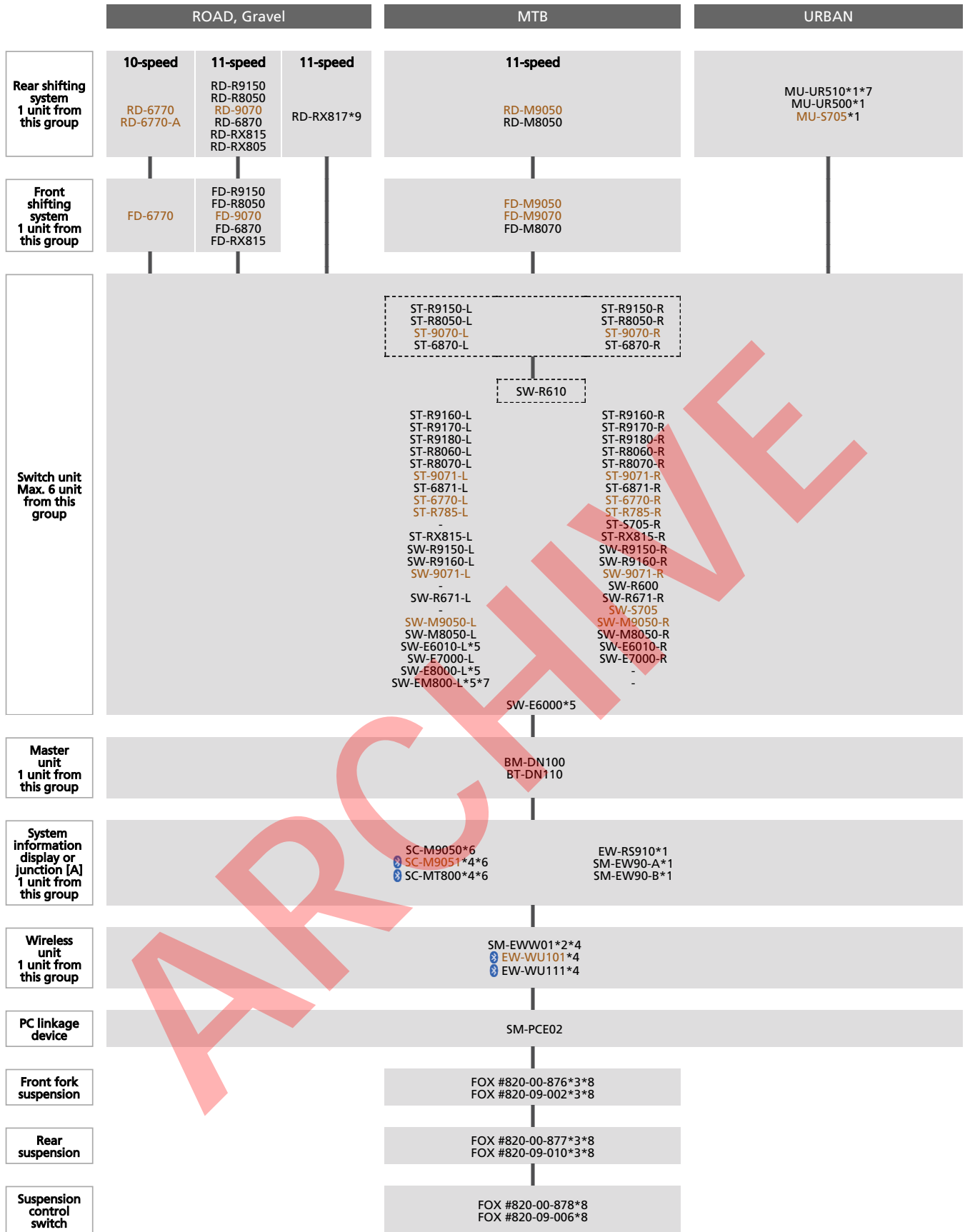

## Limitation of function with BM-DN100 / BT-DN110

- \*1 Shifting adjustment mode for MU-S705, MU-UR500 and MU-UR510 is not supported (need E-TUBE PROJECT to adjust)
- \*2 Not supported by E-TUBE PROJECT Cyclist
- \*3 A designated control switch and/or the combination SW-M9050/SW-M8050-L with SC-M9050/SC-M9051/SC-MT800 is required to operate
- \*4 The system accepts just 1 unit with wireless chip (doesn't work if plural units with wireless chip are connected)
- \*5 Need to change switch setting by E-TUBE PROJECT
- \*6 SC-M9050, SC-M9051 or SC-MT800 is required for SYNCHRONIZED SHIFT in MTB category
- \*7 This unit has SD300 port, and needs EW-AD305 for connection
- \*8 Only supported by E-TUBE PROJECT Cyclist
- \*9 For front single models only. Cannot be used in combination with a front derailleur.

ARCHIVE

# Di2 with SM-BMR1 / SM-BMR2 / SM-BTR2

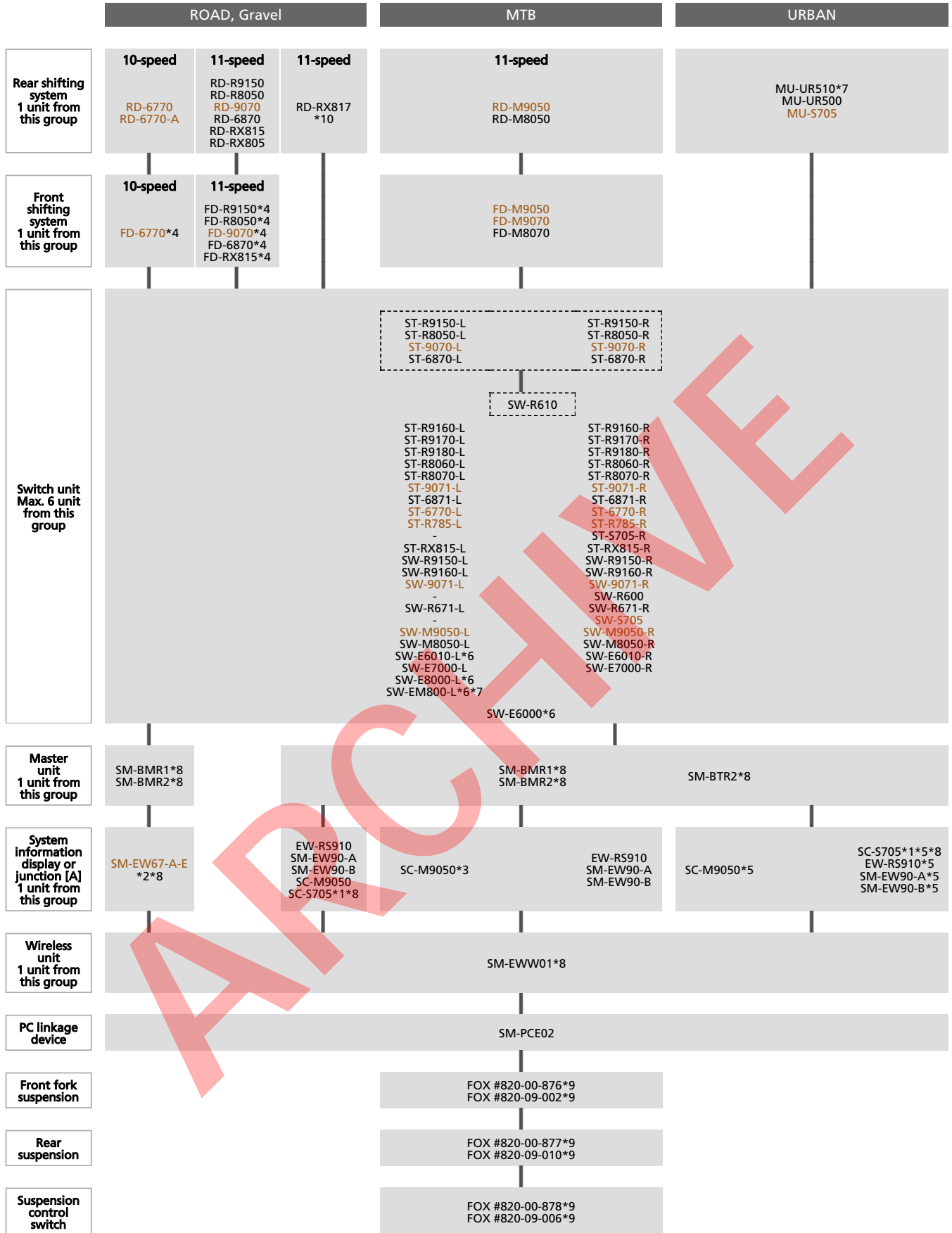

## Limitation of function with SM-BMR1 / SM-BMR2 / SM-BTR2

### \*1 SC-S705

- Front derailleur position will not appear on display.
- Recovery from Rear derailleur protection function is not available.
- Front / Rear derailleur adjustment mode is not available. Use E-TUBE PROJECT software.
- SC-S705 has only 1 SD50 port for ST / SW.
- SC-S705 may not turn on the display by front shift switch.

### \*2 SM-BCR2 requires any device which has charging port.

SM-EW67-A-E (Junction [A]) is not compatible with SM-BCR2 and SM-BTR2.

### \*3 SC-M9050 is required for SYNCHRONIZED SHIFT in case with MTB-type Rear Derailleur

### \*4 SYNCHRONIZED SHIFT is not available with Road-type Rear Derailleur

### \*5 Shifting adjustment mode for MU-S705 , MU-UR500 and MU-UR510 is not supported (need E-TUBE PROJECT to adjust)

### \*6 Need to change switch setting by E-TUBE PROJECT

### \*7 This unit has SD300 port, and needs EW-AD305 for connection

### \*8 Only supported by E-TUBE PROJECT Cyclist

### \*9 Not supported by E-TUBE PROJECT Cyclist

### \*10 For front single models only. Cannot be used in combination with a front derailleur.

ARCHIVE

## Compatibility chart of E-TUBE PROJECT Professional v5.2.0

### Di2 with EW-EX310

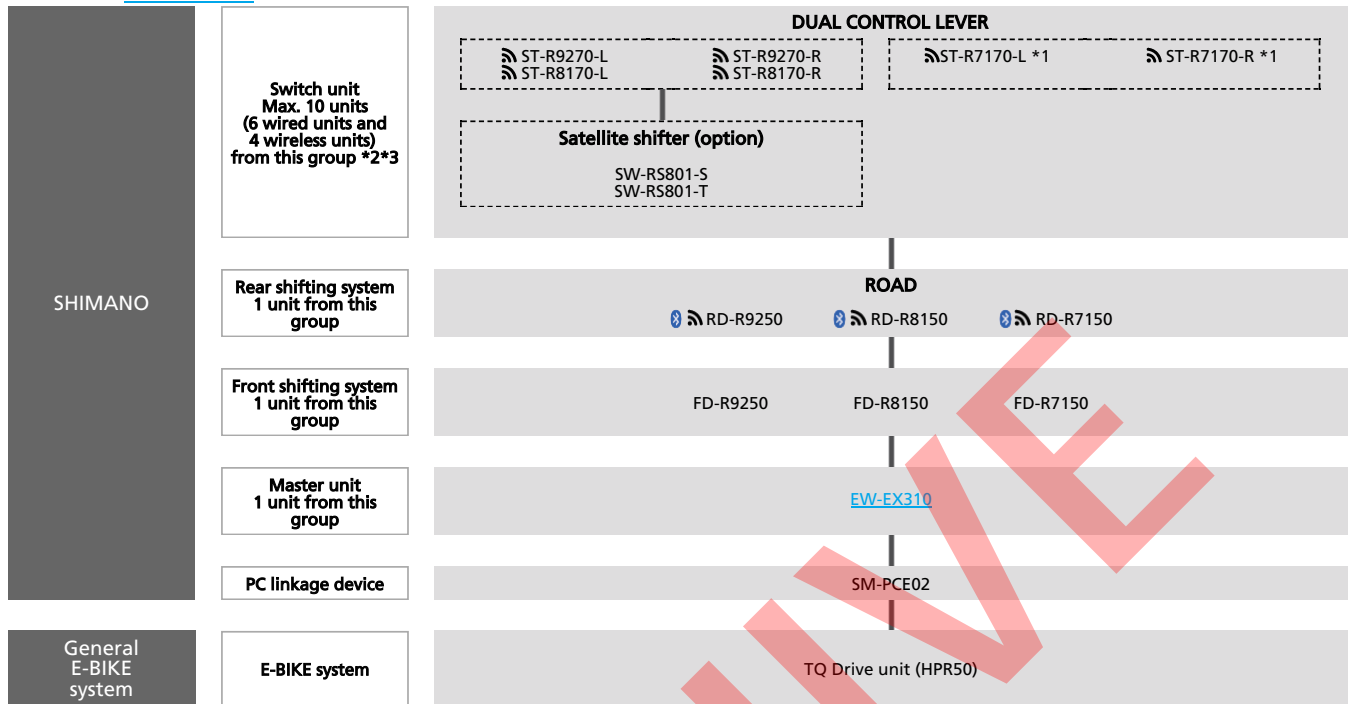

### Limitation of function

- \*1 Wireless connection only
- \*2 Wireless DUAL CONTROL LEVERs must be paired Right and Left (It's not allowed to choose two of right side units or 2 of left side units)
- \*3 There is no limitation to connect switch unit for right side or left side unit in case of it's wired connection



## Di2 with EW-EX010

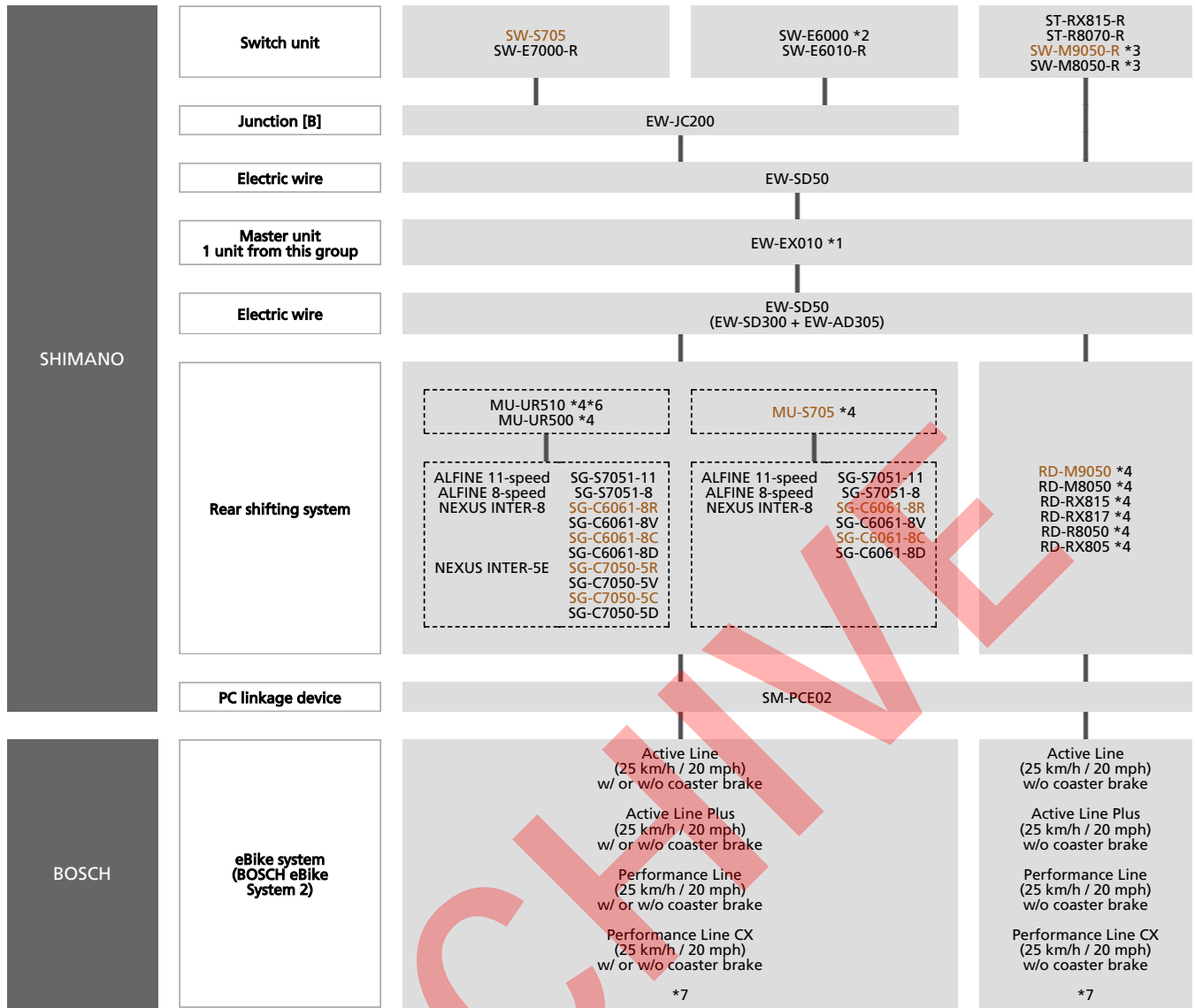

### Limitation of function

- \*1 EW-EX010 and BOSCH eBike system are connected by Y-harness which is provided by BOSCH
- \*2 Need to change switch setting by E-TUBE PROJECT.
- \*3 Cannot change manual shift to full automatic shift and its opposite.
- \*4 Full automatic shift is available only with internal geared hub by MU-S705 / MU-UR500 / MU-UR510. (Not available with rear derailleur)
- \*5 Compatible with 8-speed and 11-speed internal geared hub system only.
- \*6 This unit has SD300 port and needs EW-JC305 for connection with SD50 port unit.
- \*7 No compatibility with "Classic+ Line" and "Performance Line (45 km/h)"

## Compatibility between Bracket and ID/SC

C-548

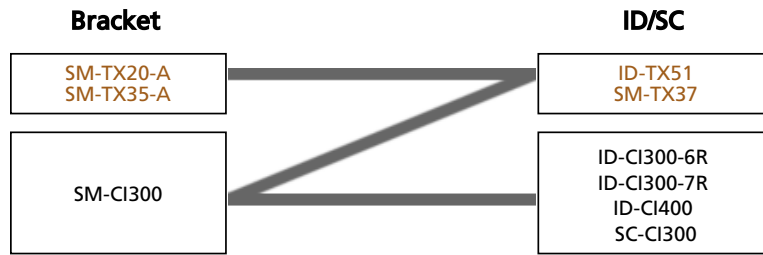

ARCHIVE